

GE Healthcare
Life Sciences

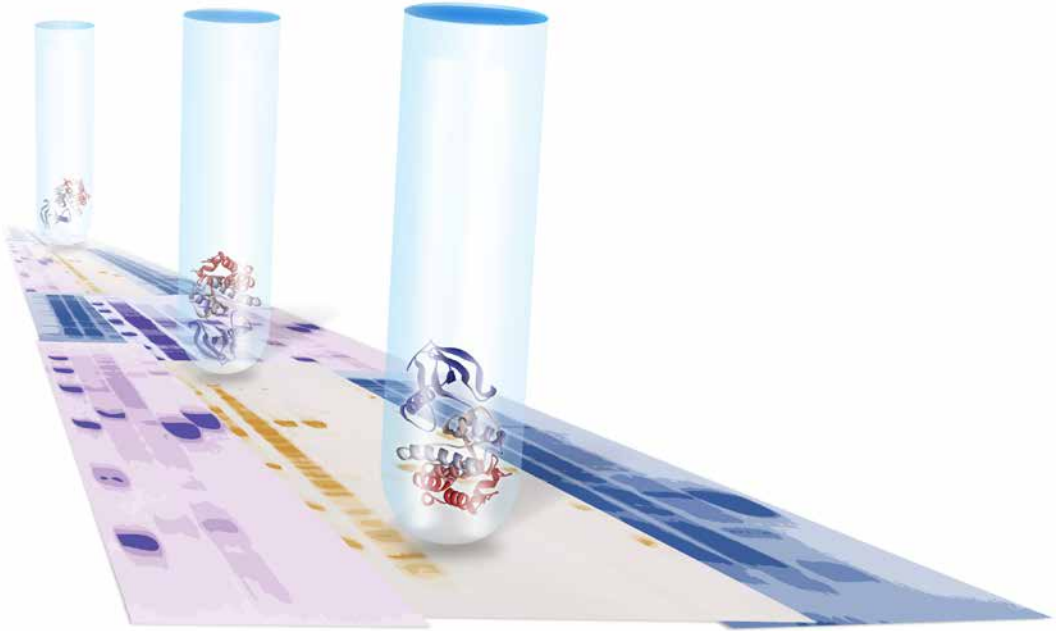

Protein Sample Preparation

Handbook



Handbooks from GE Healthcare Life Sciences

For more information refer to www.gelifesciences.com/handbooks



2-D Electrophoresis using immobilized pH gradients
Principles and Methods
80-6429-60



GST Gene Fusion System Handbook
18-1157-58

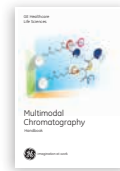

Multimodal Chromatography Handbook
29-0548-08

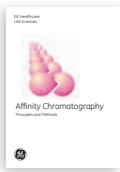

Affinity Chromatography
Principles and Methods
18-1022-29



High-throughput Process Development with PreDictor Plates
Principles and Methods
28-9403-58



Nucleic Acid Sample Preparation for Downstream Analyses
Principles and Methods
28-9624-00



ÄKTA Laboratory-scale Chromatography Systems Instrument Management Handbook
29-0108-31

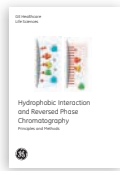

Hydrophobic Interaction and Reversed Phase Chromatography
Principles and Methods
11-0012-69



Protein Sample Preparation Handbook
28-9887-41

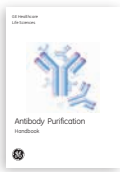

Antibody Purification Handbook
18-1037-46



Imaging Principles and Methods
29-0203-01



Purifying Challenging Proteins Principles and Methods
28-9095-31

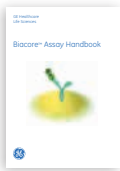

Biacore Assay Handbook
29-0194-00

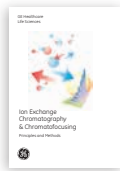

Ion Exchange Chromatography and Chromatofocusing
Principles and Methods
11-0004-21



Recombinant Protein Purification Handbook
Principles and Methods
18-1142-75

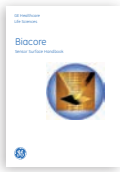

Biacore Sensor Surface BR-1005-71



Isolation of mononuclear cells Methodology and Applications
18-1152-69

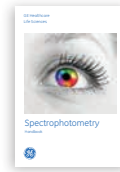

Spectrophotometry Handbook
29-0331-82



Cell Separation Media Methodology and Applications
18-1115-69



MicroCal Calorimetry—Achieving High Quality Data Handbook
29-0033-51



Strategies for Protein Purification Handbook
28-9833-31



Gel Filtration Principles and Methods
18-1022-18



Microcarrier Cell Culture Principles and Methods
18-1140-62



Western Blotting Principles and Methods
28-9998-97

Protein Sample Preparation

Handbook

Contents

Introduction.....	5
Focus and scope	6
Acronyms and abbreviations used in this handbook.....	7
Protein sample preparation terminology	9
Symbols used in this handbook	11
Reference.....	11
Chapter 1	
Overview of protein sample preparation.....	13
Introduction.....	13
Challenges that need to be tackled in proper sample preparation	13
Workflow design considerations and general concerns	17
Contaminant tolerance and analytical capabilities of selected techniques	22
References.....	24
Chapter 2	
Sample collection, stabilization, and protein extraction.....	27
Introduction.....	27
Overview of steps to prepare a protein extract.....	28
Sample collection.....	28
Breaking up cellular and tissue architecture.....	29
Stabilization of proteins.....	32
Solubilization of proteins.....	37
Extraction examples.....	42
Clarification of protein extract.....	49
Protein quantitation.....	49
References.....	51
Chapter 3	
Increasing detectability of targeted proteins.....	53
Introduction.....	53
Protein fractionation.....	54
Affinity-based protein depletion of high-abundance proteins.....	57
Affinity-based protein sample preparation and analysis of monoclonal antibodies in serum.....	60
Affinity-based enrichment of proteins and protein subgroups	61
References.....	76
Chapter 4	
Ensuring compatibility in protein sample preparation workflows.....	79
Introduction and overview of available methodology.....	79
Clarification.....	79
Buffer exchange and desalting.....	81
Sample cleanup.....	91
Concentration/volume reduction.....	91
References.....	92

Chapter 5	
Increasing sample throughput/screening applications.....	93
Introduction.....	93
Available formats	93
Screening applications.....	99
Appendices	
Appendix 1	109
Overview of protein analysis techniques.....	109
Appendix 2	
Protein determination.....	112
Appendix 3	
Chromatography columns for use with ÄKTAmicro chromatography system.....	114
Appendix 4	
Characteristics of Vivaspin sample concentrators.....	116
Appendix 5	
Characteristics of PD products prepacked with Sephadex G-25	119
Appendix 6	
Amino acid data	120
Product index	123
Related literature	124
Ordering information	125

Introduction

This handbook is divided into five chapters, starting with an overview of protein sample preparation, followed by three chapters based on a conceptual, high-level workflow for protein sample preparation and analysis (Fig I.1), and wrapping up with a chapter that focuses on parallel processing and screening strategies in recombinant protein and monoclonal antibody production workflows.

The overall goal of sample preparation, as viewed in the high-level workflow, is to feed the analytical technique of choice with protein subsamples of a quality that maximizes the chances for a successful analysis. The techniques and operations available to reach this goal are bundled into three main categories based on purpose. The first category and main sample preparation stage includes unit operations such as sample collection, stabilization, and extraction. The purpose of this stage is to move all the targeted protein population—while preserving the *in vivo* state—from the initial biological source into a homogeneous solution. Two simple examples include preparing a plasma sample from the bloodstream of a human or animal donor and creating a lysate from a cell culture. The next category and main stage embraces unit operations that improve detectability in the intended analytical technique by selectively modulating the protein content of the input solution. Operations include combinations of protein fractionation, enrichment of selected protein groups or subgroups, and depletion of high-abundance or other unwanted proteins that can interfere with the analysis. The final category contains unit operations that ensure compatibility in the overall workflow by:

1. Removing interfering nonprotein contaminants (nucleic acids, lipids, polysaccharides, phenols, etc.) present in the initial biological source
2. Removing interfering contaminants and adjusting noncompatible buffer compositions introduced during previous sample preparation or labeling operations
3. Adjusting the volume and total protein concentration to suit the next step

To ensure full compatibility in a workflow, multiple modulations at various points are generally needed.

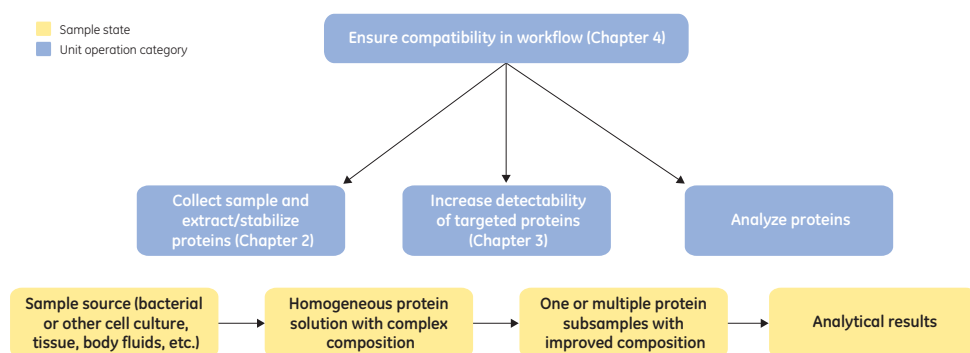

Fig I.1. High-level workflow for protein sample preparation and analysis.

Focus and scope

This handbook is intended for both students and experienced practitioners in the protein research field who have an interest in “getting it right from the start.” Rather than providing a large number of detailed protocols that have been optimized for specific samples and purposes, this handbook focuses on providing a background understanding and feel for important considerations in the design process of sample preparation unit operations. Representative protocols are presented in a step-by-step summary format, but details will typically have to be changed to tailor them for individual situations. Furthermore, the scope of this handbook does not allow for in-depth discussion of potential alternatives to the protocols presented, but it does provide guidance, hints, and tips applicable in a wider context.

Three main sample source categories are defined and covered in this handbook:

1. Recombinant sources
 - a. Includes cells that are used for introduction of one heterologous gene for overexpression of a particular protein.
 - b. Subgroups are recombinant:
 - Bacteria
 - Yeast
 - Insect cells
 - Mammalian cells
 - c. The purpose is to purify this single protein for analytical assessment, for use as antigens in affinity binder generation, or as standards in quantitation assays.
 - d. Screening of clones for the presence of functional recombinant protein or screening of purification conditions is to be performed.
2. Biological model systems
 - a. Includes both natural and genetically modified organisms used to gain insights into particular biological processes at a more global view than can be achieved by studying single proteins (e.g., disease models).
 - b. Subgroups are:
 - Viruses
 - Nonrecombinant bacteria
 - Nonrecombinant yeast
 - Primary cell cultures
 - Mammalian, including human, cell lines
 - Animal or human tissue
 - Plant tissue
 - Animal or human body fluids
3. Hybridoma cell lines used for the production of monoclonal antibodies

The main focus in the following chapters is on unit sample preparation operations performed in formats/devices compatible with general laboratory equipment, that is, microcentrifuge tubes, spin columns, prepacked columns, filter cartridges, paramagnetic beads, and prepacked multiwell plates.

Detailed coverage of expression and purification of recombinant protein constructs or monoclonal antibodies is outside the scope of this handbook. For in-depth guidance, readers are referred to reference 1 and relevant handbooks from GE Healthcare Life Sciences (*Recombinant Protein Purification Handbook, Principles and Methods* (article code number 18-1142-75); *Antibody Purification, Principles and Methods* (article code number 18-1037-46); and *Purifying Challenging Proteins* (article code number 28-9095-31). However, a special task

for protein sample preparation as defined in this handbook is to provide techniques/technology enabling initial small-scale screening strategies in recombinant protein production (i.e., expression and solubility screening) or monoclonal antibody generation (i.e., expression screening and screening of binding properties). General aspects of extraction and stabilization are of course also applicable to recombinant sources.

Sample preparation methodology for broad assessment of proteins in biological model systems is the main focus of this handbook. For guidance on purifying individual proteins from these sample sources, readers are referred to the handbook *Strategies for Protein Purification* from GE Healthcare (article code number 28-9833-31). Only techniques involving the handling of proteins in solution are covered, thus excluding workflows based on immunohistochemistry and cell assays. In addition, the main focus is on workflows using protein-independent analytical procedures such as mass spectrometry (MS) and electrophoresis. However, several of the sample preparation techniques covered are generally applicable to many situations where the properties of a protein solution need to be manipulated. Details on major challenges that sample preparation needs to handle in the above context are given in Chapter 1 for selected protein analysis techniques. An overview of these techniques is given in Appendix 1.

Acronyms and abbreviations used in this handbook

A ₂₈₀	UV absorbance at specified wavelength measured in nanometers (nm), in this example, 280 nm
AAA	amino acid analysis
Ab	antibody
AC	affinity chromatography
ACES	N-(2-Acetamido)-2-aminoethanesulfonic acid (biological buffer)
ADA	N-(2-Acetamido)iminodiacetic acid (biological buffer)
AEBSF	aminoethyl benzylsulfonyle fluoride (serine protease inhibitor)
AIEX	anion exchange chromatography
AP	alkaline phosphatase
APMSF	4-aminophenyl-methylsulfonyle fluoride (serine protease inhibitor)
ASB	amidofobetaine
BCA	bicinchoninic acid
BES	N,N-Bis(2-hydroxyethyl)-2-aminoethanesulfonic acid
BME	β-mercaptoethanol
BSA	bovine serum albumin
CAPS	N-cyclohexyl-3-aminopropanesulfonic acid (biological buffer)
CAPSO	3-(Cyclohexylamino)-2-hydroxy-1-propanesulfonic acid (biological buffer)
CHAPS	3-[(3-cholamidopropyl)dimethylammonio]-1-propanesulfonate
CHAPSO	3-[(3-cholamidopropyl)dimethylammonio]-2-hydroxy-1-propanesulfonate
CHES	N-Cyclohexyl-2-aminoethanesulfonic acid (biological buffer)
CHO	Chinese hamster ovary
CIP	cleaning-in-place
CMC	critical micellar concentration
CSF	cerebrospinal fluid
CTAB	cetyl trimethylammonium bromide (surfactant)
Da	Dalton
DDM	n-dodecyl-β-D-maltoside (detergent)
DIGE	differential gel electrophoresis (sometimes referred to as 2-D DIGE)
DMP	dimethyl pimelimidate dihydrochloride
DNase	deoxyribonuclease
DTE	dithioerythritol, also 1,4 dithioerythritol (reducing agent)
DTT	dithiothreitol, also 1,4 dithiothreitol (reducing agent, Cleland's reagent)
<i>E. coli</i>	<i>Escherichia coli</i>

ECL	enhanced chemiluminescence
EDTA	ethylenediaminetetraacetic acid (chelating agent)
EGTA	ethylene glycol tetraacetic acid (chelating agent)
ELISA	enzyme-linked immunosorbent assay
EPPS	3-[4-(2-hydroxyethyl)-1-piperazinyl] propanesulfonic acid (biological buffer)
ESI	electrospray ionization
ESI-MS	electrospray ionization-mass spectrometry
FA	formic acid
FAK	focal adhesion kinase
GABA	gamma-aminobutyric acid (biological buffer)
GF	gel filtration (sometimes referred to as SEC; size exclusion chromatography)
GST	glutathione S-transferase
HEPES	(4-(2-hydroxyethyl)-1-piperazineethanesulfonic acid (biological buffer)
HIC	hydrophobic interaction chromatography
HMW	high molecular weight
HP	high performance
HPLC	high-performance liquid chromatography
HRP	horseradish peroxidase
IAA	iodoacetamide
IEF	isoelectric focusing; usually the first dimension in 2-D electrophoresis
IEX	ion exchange chromatography (also seen as IEC in the literature)
IMAC	immobilized metal ion affinity chromatography
IPG	immobilized pH gradient
IUBMB	International Union of Biochemistry and Molecular Biology
LC	liquid chromatography
LC-MS	liquid chromatography-mass spectrometry
LDAO	lauryldimethylamine oxide (detergent)
LMW	low molecular weight
LPS	lipopolysaccharides
MAb	monoclonal antibody; plural is MAbs
MALDI	matrix-assisted laser desorption ionization
MALDI-MS	matrix-assisted laser desorption ionization-mass spectrometry
MALDI-ToF	matrix-assisted laser desorption ionization-time of flight
MBP	maltose binding protein
MES	2-(N-morpholino)ethanesulfonic acid (biological buffer)
MOAC	metal oxide affinity chromatography
MOPS	3-(N-morpholino)propanesulfonic acid (biological buffer)
MPa	megaPascal
M_r	relative molecular weight
MS	mass spectrometry
MS/MS	tandem MS
MW	molecular weight
MWCO	molecular weight cutoff
NP-40	nonyl phenoxypolyethoxyethanol
PBS	phosphate-buffered saline (biological buffer)
PEG	polyethylene glycol
PES	polyethersulfone
pI	isoelectric point, the pH at which a protein has zero net surface charge
PIPES	Piperazine-1,4-bis(2-ethanesulfonic acid) (biological buffer)
pK_a	acid dissociation constant
PKA	protein kinase A
PKC	protein kinase C
PMF	peptide mass fingerprinting

PMSF	phenylmethylsulfonyl fluoride (serine protease inhibitor)
PTM	post-translational modification; plural is PTMs
PTP	phosphotyrosyl phosphatase
PTRF	polymerase I-transcript release factor
pTyr	phosphorylated tyrosine residue in proteins
PVDF	polyvinylidene fluoride
RC	regenerated cellulose
RIA	radioimmunoassay
RIPA	radioimmunoprecipitation assay
RNase	ribonuclease
RPC	reversed phase chromatography
RSD	relative standard deviation
SDS	sodium dodecyl sulfate (detergent)
SDS-PAGE	sodium dodecyl sulfate polyacrylamide gel electrophoresis
SEC	size-exclusion chromatography (same as gel filtration, GF)
SNAG1	sorting nexin associated Golgi protein-1
SNP	single nucleotide polymorphism
SPE	solid-phase extraction
SRM	selected reaction monitoring
TAPS	N-Tris(hydroxymethyl)methyl-3-aminopropanesulfonic acid (biological buffer)
TBS	tris-buffered saline (biological buffer)
TCA	trichloroacetic acid
TCEP	tris(2-carboxyethyl)phosphine hydrochloride (reducing agent)
TES	N-Tris(hydroxymethyl)methyl-2-aminoethanesulfonic acid (biological buffer)
TFA	trifluoroacetic acid
TLCK	tosyl-L-lysine chloromethyl ketone (serine protease inhibitor)
ToF	time-of-flight
TPCK	tosyl-L-phenylalanine chloromethyl ketone (serine protease inhibitor)
u	unit (unit for activity of an enzyme)
UF	ultrafiltration
UV	ultraviolet light
VEGF	vascular endothelial growth factor
Vis	visible light

Protein sample preparation terminology

Abundance	Concentration or number of copies of specific proteins in a given sample source. Mostly used as a relative term, for example, high or low abundance.
Affinity chromatography (AC)	A group of techniques used to separate and purify a biological molecule from a mixture, based on various types of specific affinities between target molecule(s) and a specific ligand coupled to a chromatography medium. An example of this includes a protein and a specific ligand coupled to a chromatography medium.
Affinity enrichment	Enrichment of protein(s) of interest using AC.
Buffer exchange and desalting	Manipulating the buffer system (including pH) and reducing the concentration of small ionic species in samples.
Clarification	Removing cell debris, aggregated proteins, etc. from the sample to avoid complications such as clogging of filters/columns in later purification steps.

Complexity	The number of protein species and isoforms in a given sample. Isoforms can come from alternative splicing variants or from PTMs, etc. High-complexity samples often contain more proteins and isoforms that exceed the resolution power of a given analytical technique.
Concentration/volume reduction	Adjusting volume and global protein concentrations of dilute and/or large volume samples for matching demands of the next step in the workflow.
Contaminant	Chemical or biological molecule that interferes with analysis of the target protein(s); different analytical techniques have different tolerances for specific contaminants.
Diafiltration	Changing buffer composition and the concentration of small contaminants by repeated dilution followed by volume reduction using ultrafiltration (UF).
Dynamic range (of proteins; of assays)	The ratio between the largest and smallest possible values of a changeable quantity. In protein analysis, the dynamic range might be the range in the amount of protein from the lowest level of detection to saturation of the detector or analytical system. The linear dynamic range is the analyte concentration range within which the analytical signal is linear.
Enrichment	Selectively increasing the relative amount of the protein target(s) of low-abundance proteins; usually performed using AC.
Fractionation	Procedures used to divide an initial solubilized protein population into multiple subsamples/fractions based on differences in physical/chemical properties of the proteins present (i.e., size, charge distribution, isoelectric point (pI), hydrophobicity, or solubility).
Gel filtration (GF)	Size-exclusion chromatography. Separates solutes (e.g., proteins) according to size.
Hydrophobic interaction chromatography (HIC)	Technique based on the hydrophobic interaction between solutes (e.g., proteins) and the chromatography medium in the presence of high salt concentration.
Ion exchange chromatography (IEX)	Technique based on electrostatic interactions between solutes (e.g., proteins) and chromatography medium.
Microfiltration	Technique in which a porous membrane (0.1 to 1.0 μm) is used to remove particulate material from protein solutions. Commonly, liquid solutions are pushed through using a syringe or a vacuum manifold.
Parallel processing	Term often used when referring to samples processed simultaneously.
Phosphopeptides	These contain one or more phosphate groups, often obtained by phosphorylation. Samples are often enzyme-digested to obtain peptide fragments prior to downstream analysis.
Protein depletion	Removal of high-abundance proteins.
Protein sample preparation	If the main purpose of a workflow is protein analysis in some form, every unit operation prior to analysis is considered sample preparation.
Proteome	The set of all proteins expressed in a given cell or organism under defined conditions.

Proteomics	Global-scale study of protein interactions, expression, and functionality.
Reversed phase chromatography (RPC)	Technique based on hydrophobic interactions between solutes (sample components) and ligands coupled to a chromatography medium. Organic modifiers (e.g., acetonitrile) in the eluent are used for elution.
Sample cleanup	A set of techniques used to remove contaminants such as detergents, lipids, polysaccharides, nucleic acids, and phenols from protein solutions.
Sample state	The composition of a sample after a given unit operation is performed.
Sample throughput	The number of samples that are processed. Term can apply to the number of samples processed simultaneously (parallel processing) or to the number processed in a specified time period.
Size-exclusion chromatography (SEC)	Same as gel filtration (GF).
Ultrafiltration (UF)	In UF, liquid sample is forced against a membrane with smaller and more defined pore sizes than in microfiltration. Molecules larger than the pores are retained (retentate) whereas smaller molecules and solvent pass through the membrane (filtrate). Pore sizes are often defined as Molecular Weight Cutoff (MWCO) values.
Unit operation	Process being performed on a sample, for example, buffer exchange/desalting or affinity enrichment.
Unit operation category	Broad grouping of unit operations that refers to the purpose of the operations, for example, increasing detectability of target proteins.
Western blotting	An analytical method that detects specific proteins within a protein mixture by a multistep process consisting of electrophoresis on a slab gel, transfer of the proteins on the gel to a membrane, and identification of the specific proteins by antibody staining; also known as immunoblotting.
Workflow; Sample preparation	A sequence of connected steps starting at the sample source and ending at protein analysis.

Symbols used in this handbook



This symbol indicates general advice to improve procedures or recommend action under specific situations.



This symbol denotes mandatory advice and gives a warning when special care should be taken.

Reference

1. Structural Genomics Consortium *et al.* Protein production and purification. *Nat. Methods* **5**, 135–147 (2008).

Chapter 1

Overview of protein sample preparation

Introduction

Almost all protein samples need further preparation after collection. The quality of such preparation is critical to successful protein analysis. Therefore, there is an absolute requirement to give sample preparation the attention it deserves to ensure the optimal analytical results. The goal of this handbook is to provide useful information and guidance to make this very important starting point as well-defined and efficient as possible.

What do we mean by protein sample preparation?

The term *protein sample preparation* can mean different things to different people, and strict definitions are truly relevant only in a defined workflow. For example, the use of chromatography methods is often considered to be part of sample preparation if the purpose is protein fractionation in proteomics studies, but it is less likely to be considered a part of sample preparation if the purpose is isolation and characterization of a single protein. In this handbook, we adopt a wide definition: If the main purpose of a workflow is protein analysis, every unit operation except analysis is considered sample preparation.

Driving forces behind protein sample preparation

There is increasing demand for high-quality, small-scale protein preparations for analytical purposes. As protein analysis has become complex and sensitive, the need for adequate screening techniques has likewise grown. Protein sample preparation is a critical consideration for researchers in the following areas:

- Proteomics
- Functional genomics
- Clinical studies (e.g., comparing protein sample before and after “treatment”)
- Differential expression
- Protein atlas studies (i.e., studying expression and localization of proteins within different cell types)
- Structural studies
- Functional studies

Challenges that need to be tackled in proper sample preparation

New and improved analytical techniques are constantly evolving, yet many of the fundamental challenges still need to be handled by proper sample preparation. The main challenges that need to be addressed by sample preparation are briefly outlined below.

Protein complexity and dynamic range

Proteins in biological samples are highly complex, and post-translational modifications (PTMs) can increase the complexity further. In addition, the abundance of different protein species in a biological sample can vary widely. For example, the abundance of proteins in *Saccharomyces cerevisiae* ranges from fewer than 50 to more than 10^6 molecules per cell (1). Another example is blood serum that contains 60 to 80 mg/ml of protein but about half of this is albumin and up to one quarter is γ -globulin. Due to the high complexity and dynamic range of protein species present in total protein extracts from biological sources, global analytical techniques such as MS or electrophoresis are not capable of detecting all the proteins present (Fig 1.1).

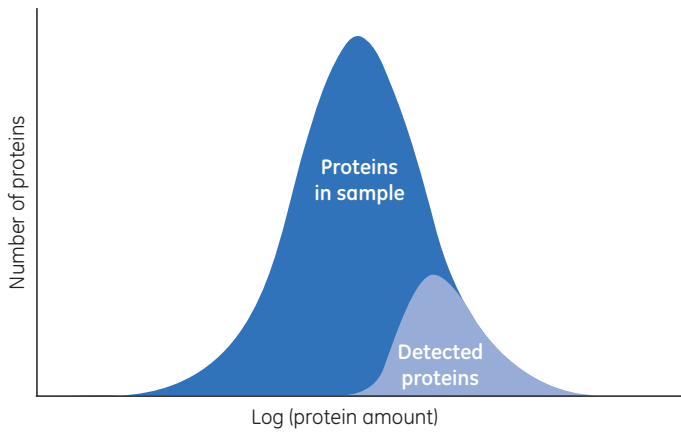

Fig 1.1. 2-D gel electrophoresis and global MS techniques are capable of detecting only a small portion of the proteins present in a total protein extract from a complex biological source. Figure adapted from reference 2.

A rough overview of the dynamic range and protein complexity found in the different sample sources is shown in Table 1.1. In general, analytical performance of electrophoresis or MS-based techniques is reduced with increased complexity and dynamic range in the sample. In fact, without sample preparation strategies to reduce the complexity and dynamic range of samples, even medium-abundance protein species are likely to be detected and/or quantitated nonreproducibly during repeat experiments. Without a targeted approach to improve detectability, the low-abundance part of proteomes, where most specific biomarkers are thought to reside, would be inaccessible. This is due to three main reasons:

1. A mismatch in dynamic range between biological samples and analytical techniques

The dynamic range found in many biological sources varies from ~ 5 to 12 orders of magnitude (Table 1.1), yet global electrophoresis and MS-based techniques are currently capable of handling a dynamic range of only ~ 2 to 3 orders of magnitude (Table 1.5).

2. Inability of analytical techniques to handle the complexity of biological samples

Even if the dynamic range could be reduced, very high sample complexity cannot be handled by current techniques. With an increased number of proteins present, a lower amount of each individual protein can be subjected to the analytical method. In addition, 2-D gel electrophoresis cannot resolve all the protein forms present, and the mass spectrometers used in liquid chromatography (LC)-mass spectrometry (LC-MS/MS) approaches are hampered by ionization suppression effects, insufficient resolving power, and limitations in MS/MS scan speed. Even if peptides are resolved and detectable in MS mode, there is insufficient time to perform MS/MS scans for all peptide ions present at each point in the chromatogram.

3. Insufficient sensitivity of analytical techniques

Aside from the dynamic range and complexity challenges without manipulating the concentration of proteins in some way, current MS or 2-D gel electrophoresis techniques are not sensitive enough to analyze the low-abundance part of many proteomes (sub ng/ml concentrations; Table 1.5).

Table 1.1. Overview of dynamic range and complexity in selected sample sources (1–5)

Source	Dynamic range	Number of proteins	Comments
Bacteria	$\sim 10^5$	$\sim 10^3$	Protein composition varies depending on species and culture conditions.
Cultured animal or human cells	$\sim 10^{5-6}$	$\sim 10^4$	If the biological state and/or cell type is not well-controlled during culture, complexity will increase further.
Tissue	Increased compared with cell culture samples due to the presence of multiple cell types	Increased compared with cell culture samples due to the presence of multiple cell types	Sample characteristics will vary heavily depending on the specific tissue and the precision of sample collection from that tissue. In general, it is important to keep the heterogeneity of the isolated tissue as low as possible, while keeping the analytical purpose in mind.
Plasma	$\sim 10^{10-12}$	$\sim 10^6$	Blood perfuses all other tissues in the body, and most cells are thought to leak or secrete proteins into circulation. Therefore, the plasma proteome is the most complex proteome and can reflect the health status of every organ and tissue in the body. It is therefore of great interest for biomarker development.
Other human or animal body fluids	Lower than plasma	Lower than plasma	Due to the complexity of plasma, other body fluids are increasingly being used during biomarker development even if the ultimate goal is a blood test. Many biomarkers specific for a particular disease are thought to arise locally from the affected tissue, displaying a gradient of diminishing concentration with increasing distance from disease and decreasing markedly with admixture into the blood. The term proximal fluid has been defined as a body fluid closer to, or in direct contact with, the site of disease (6).

Protein detectability is improved if targeted approaches can be used to reduce the dynamic range of proteins in the biological sample. However, affinity-based approaches are generally used to detect most proteins present. In the absence of antibodies (or other affinity binders), sample preparation operations are essential to improve detectability in a complex sample.

Protecting proteins from degradation

Protecting proteins from the action of proteases and other protein-modifying enzymes is a critical consideration for ensuring that analytical results can be trusted to mirror the *in vivo* state of the proteins or proteomes analyzed in tissue- and cell-based samples. Incomplete protein protection might destroy or distort vital information about the protein population, which leads to large variations in results and incorrect conclusions. Detrimental enzymatic activity is less of a concern in most body fluids, because the causal enzymes are generally part of cellular pathways for signal transduction and controlled protein degradation. The blood-clotting cascade is of course a well-known exception that needs to be avoided or activated in a well-controlled fashion in the creation of plasma or serum samples, respectively.

Although the above-mentioned enzyme systems are part of normal cellular processes, two mandatory sample preparation steps cause them to exert detrimental enzymatic activity in a way that distorts the presampling proteome:

1. The sample collection or sampling step removes a tissue sample from its natural surroundings, leading to a major disturbance of tissue homeostasis. This in turn causes a release of degradation mediators, leading to an increased activity of different proteases and enzymes involved in PTMs. Similar stress responses can also be activated during sampling from cell cultures.
2. Under *in vivo* conditions, many of the cellular proteins are kept separate from proteolytic enzymes. Disruption of cellular and tissue architecture during protein extraction causes distortion of the *in vivo* state by making all proteins potentially accessible for degradation or modification.

If not controlled, degradation and protein modification can potentially take place throughout the whole sample preparation workflow. However, large variations based on type of sample source are to be expected. Recently it has been shown that detrimental effects can be more rapid than previously thought. Extensive proteolysis has been demonstrated already 3 min after sampling, and the levels of several PTMs in brain tissue are significantly changed within minutes *post-mortem* (7).

Global protein extraction

The large heterogeneity of proteins and interfering contaminants of any cell- or tissue-based sample source makes global extraction, the simultaneous release and solubilization of all proteins, a great challenge. Integration of proteins into membranes and the formation of complexes with other proteins or nucleic acids hamper the extraction process significantly. As a consequence, extracted protein populations are likely to be more or less distorted compared to *in vivo* populations. Minimizing these effects by optimizing the extraction protocol is a challenging task that generally has to be reiterated for each new sample source and analytical purpose.

Complete removal of nonprotein contaminants

The concentration of contaminants such as salts, nucleic acids, lipids-polysaccharides, and phenols varies widely with sample source (8). Their presence can substantially reduce the performance of both sample preparation and analytical techniques. Additional substances, such as detergents, added to improve one aspect of the workflow often interfere with later steps.

Introduction of additional sample preparation artifacts

In addition to enzymatic degradation and incomplete extraction, other processes threaten to lower the overall sensitivity and distort the original protein distribution. They include:

- Precipitation or aggregation caused by intentional or unintentional changes of the physical or chemical properties of protein solutions (temperature, pH, salt or detergent concentration, etc.).
- Nonspecific adsorption to surfaces exposed by sample vials, liquid-handling tips, or solid-phase manipulators such as chromatography media, filters, membranes, or magnetic beads.
- Introduction of chemical modifications of proteins (e.g., oxidation) induced by sample handling.

These effects tend to increase in magnitude with increasing number and complexity of unit operations included in the workflow.

Workflow design considerations and general concerns

The first rule for the design of a successful protein analysis workflow is to maintain a holistic view and collect as much background information as possible (1,2). It is advisable to keep manipulations of the nonprotein properties of sample solutions at a minimum, as all available techniques introduce some level of protein loss.

1. Clearly define the purpose or goal of the overall experiment or study.
2. Consider different analytical strategies that can be used in accordance with the purpose.
 - Is global protein analysis required or can the sought-after protein population be narrowed down by existing knowledge or legitimate hypotheses?
 - Can different sample sources be used?
 - Can different analytical techniques or modes of operation be used?

 Is the analytical purpose compatible with focusing on only a subpart of a cellular proteome? If so, employ subcellular fractionation techniques to reduce complexity and maximize relevance (Chapter 2).

 Do multiple choices exist that are compatible with the analytical purpose? Which is the most favorable? For example, proximal biofluids should be considered as alternatives to plasma for initial biomarker discovery (Table 1.1). Compared to plasma biofluids, proximal biofluids are less complex and are likely to be naturally enriched in potential biomarker candidates. Targeted verification and validation of candidates can then be performed in plasma if a blood test is the final goal.

 Does background knowledge on potentially interesting proteins exist? Consider using target-tailored analytical techniques (targeted LC-MS/MS, Western blots, or enzyme-linked immunosorbent assay [ELISA] or its modern alternatives). These techniques offer increased sensitivity and are less influenced by high sample complexity and dynamic range (Table 1.5). Therefore, they require less sample preparation.
3. Know the sample sources available to you!
 - Protein complexity and dynamic range
 - Rough concentration of the sought-after protein population
 - Are dynamics in the sought-after protein population thought to be well reflected in the sample source?
 - Type and abundance of contaminants
 - Compartmentalization of proteins and difficulty of extraction
 - Level and type of detrimental enzymatic activity
4. Know the analytical techniques available to you! What are their criteria for optimal overall detectability? (See Appendix 1 for an overview of selected techniques.)
 - Range of total protein amount loaded
 - Volume range
 - Limit of detection for individual proteins
 - Dynamic range
 - Complexity tolerance (~ resolving power)
 - Contaminant tolerance
 - Need for retained biological structure and activity

 Strive to reduce contaminants to acceptable levels but do not overdo it (see Tables 1.3 and 1.4 for contaminant acceptance for MALDI and 2-D gel electrophoresis, respectively).

5. Additional considerations

- Number of samples to be processed simultaneously (i.e., parallel processing, Chapter 5)
- Amount of initial sample available for each specimen
- Available resources
- Acceptable cost
- Logical order for steps and/or adjustments for certain steps



Keep the overall workflow in mind and try to minimize the instances in which adjustments are needed. Examples include avoiding Tris buffers when protein labeling on primary amines will be performed and selecting an appropriate sequence of chromatographic techniques during fractionation (i.e., IEX followed by RPC). However, by introducing adjustments at a few steps in the workflow, a better overall performance can be achieved.

6. Based on your background knowledge, list and rank the challenges associated with the different analytical strategies (combinations of sample source, targeted protein population, and analytical technique). The inverse relationship between optimal detectability, yield, and reproducibility is complex and needs to be considered as well. A general rule is to keep your design principles as simple as possible.
7. Roughly design sample preparation schemes to handle the listed challenges and assess the likelihood of success.
8. Select the most promising alternative and proceed to a detailed design of the number and type of unit operations and optimization of their performance.

Common combinations of depletion, fractionation, and affinity enrichment to improve protein detectability

See Chapter 3 for details on these techniques.

Global analysis of biofluids involves depletion of the most abundant proteins followed by extensive fractionation (> 50 fractions). Solutions exist for removal of up to the 20 most abundant proteins in plasma. However, extensive fractionation is still needed to enable deep coverage of the proteome. If the depletion solution has low capacity, it might become a bottleneck because a large amount of plasma needs to be processed to enable fractionation. There is also a concern that interesting proteins are removed during depletion, since many of the high-abundance proteins can act as carrier proteins (9, 10). Therefore, it is advisable to focus on a depletion solution that removes a moderate number of proteins with specific high capacity and also consider the bound and flowthrough fractions.

Targeted analysis of protein groups using nondenaturing conditions involves affinity enrichment only or followed by moderate fractionation. Specific binders of good quality need to be available.

Analysis using denaturing conditions involves moderate to extensive fractionation by combinations of orthogonal separation principles that are compatible in series. A common strategy is IEX followed by RPC on each first-step fraction.

Even though fractionation at the protein level is a powerful way of increasing the analytical depth in a workflow, several challenging aspects exist:

- A large amount of sample is needed to take full advantage of fractionation for enabling an increased loading of low-abundance proteins. Sufficient amounts might not be available.
- There is a decreased overall yield and increased risk of differential loss of proteins with increasing number and complexity of fractionation techniques employed.
- Time and cost constraints exist. Extensive fractionation coupled with analysis of each fraction will severely impact the throughput in the workflow and dramatically increase the cost per initial sample.

Because global analysis generally requires substantial fractionation to even start making complete coverage possible, it is recommended that targeted approaches, such as subcellular fractionation and enrichment of protein subgroups, are used whenever possible. Even if global analysis is the ultimate goal, it might be more efficient and feasible to combine the results of multiple subproteomic investigations rather than using a direct global approach. In situations where fractionation is the best approach, it is recommended to design for a minimal number of fractionation steps and subsamples to analyze, while still being able to reach the analytical goal.

Example of a complete workflow

This detailed workflow example supports the more theoretical workflow design considerations discussed above.

Background

Fundamental cellular functions such as cell signaling are commonly regulated by phosphorylation of tyrosine residues in proteins (pTyr) (11). When dysregulated, they often play a prominent role in human cancer, making the study of tyrosine-phosphorylated proteins highly interesting. A basic objective is to create a pTyr substrate map by identifying proteins that undergo tyrosine phosphorylation using global MS techniques. This hypothesis-free and global search for tyrosine-phosphorylated proteins is the purpose of the workflow outlined below. With minor adjustments, it can also be used for more detailed studies (such as differential studies) of specific tyrosine phosphorylations.

A major challenge is that most cell signaling proteins are known to reside at the lower end of intracellular protein copy number and can generally not be detected by global MS techniques directly. Another consideration is that during normal running conditions, the MS sensitivity is lower for phosphorylated peptides due to reduced ionization efficiency. The pTyr proteins are also comparatively rare in relation to other types of phosphorylations. Threonine and serine phosphorylation represents around 10% and 90%, respectively, of the total human phosphorylation, while tyrosine phosphorylation accounts for approximately 0.1% (11). In addition, *in vivo* phosphorylation levels can often be the result of simultaneous high activities of both kinases and phosphatases. If not well designed, the first steps of sample preparation will introduce a bias by shifting the delicate *in vivo* balance of enzymatic activity toward dephosphorylation (kinase activity is dependent on ATP, which is only generated during *in vivo* conditions).

Description of workflow

The workflow was built around the critical need to substantially enrich pTyr proteins prior to MS analysis. Due to the availability of pTyr-epitope-specific antibodies of good quality, highly specific affinity-based enrichment could be designed. By keeping the complete workflow in mind during the design of all steps, the number of operations could be minimized: the use of the magnetic bead format combines enrichment and concentration in one step; the use of a digestion-compatible elution buffer simplifies digestion; and concentration/desalting of peptides is performed online in direct sequence with analytical separation. Chinese hamster ovary (CHO) cells cultured in rich medium were selected as a source to enable large initial sample amounts from which to enrich as well as the option of *in vivo* inhibition of tyrosine phosphatases. By adding pervanadate, an irreversible tyrosine phosphatase inhibitor, to the culture medium 2 h prior to sample collection, the number of pTyr proteins could be maximized. Pervanadate is also known to induce other changes in the protein composition (oxidative stress response, etc.), but these artifacts were not considered to interfere with the purpose of the experiment. A control experiment without *in vivo* pervanadate treatment was included to assess the effect of inhibition. The workflow as a whole is outlined in Figure 1.2.

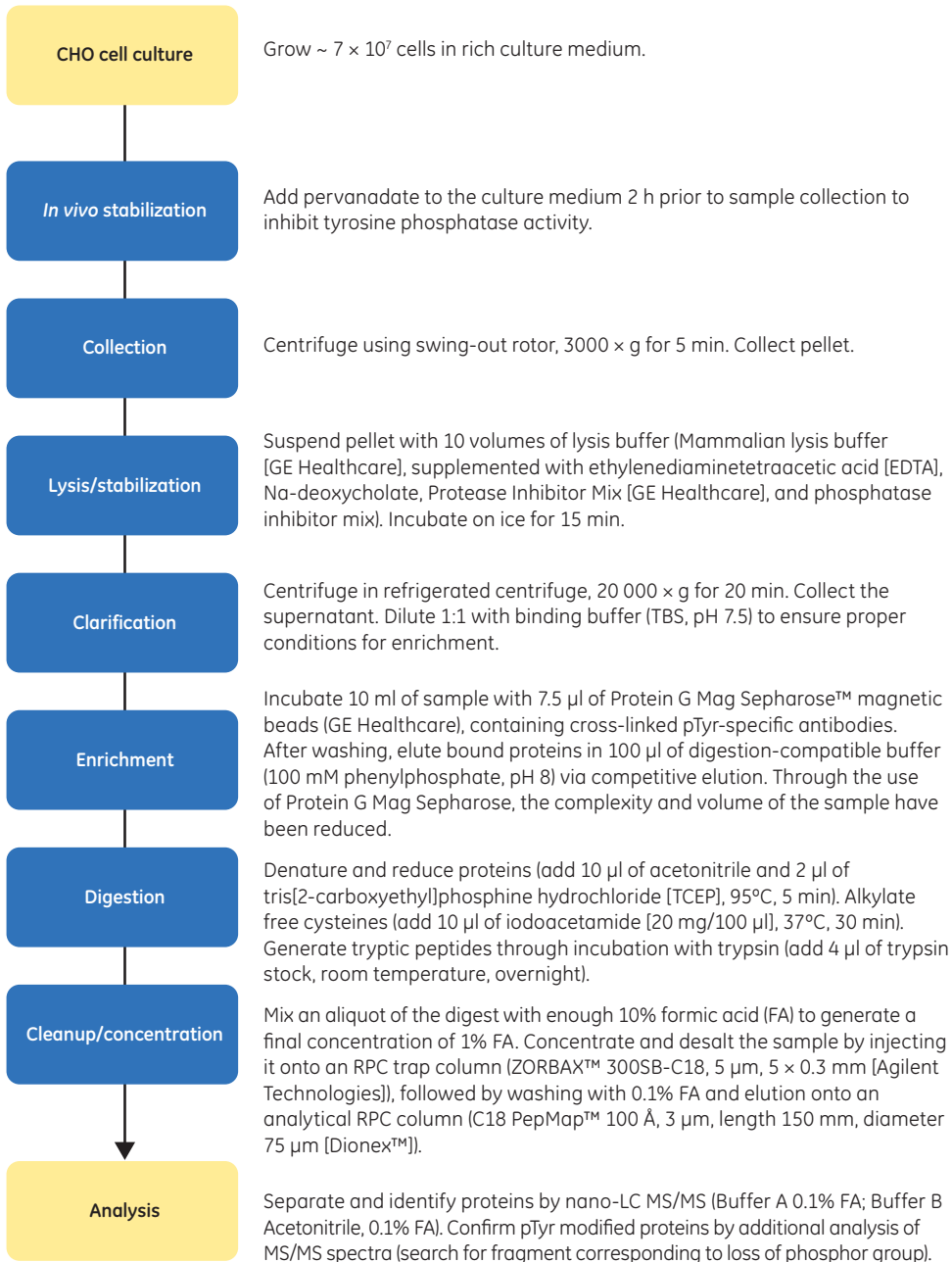

Fig 1.2. Overview of workflow for mapping of pTyr proteins in CHO cells using MS.

Using this workflow, 76 potential pTyr proteins were identified (Fig 1.3 and Table 1.2). Of these hits, 54 were exclusively found in the pervanadate treated cells and were not found in the control cells or in the starting material. Some of these proteins, such as Caveolin-1 and focal adhesion kinase (FAK), are known to be involved in focal adhesion pathways. These proteins might be involved in the regulation of the actin cytoskeleton. Other proteins that are involved in cell motility or cell survival were also found. In the control samples (untreated cells), only 22 proteins were detected, mainly highly abundant enzymes and ribosomal proteins. This clearly indicates the importance of enzymatic control.

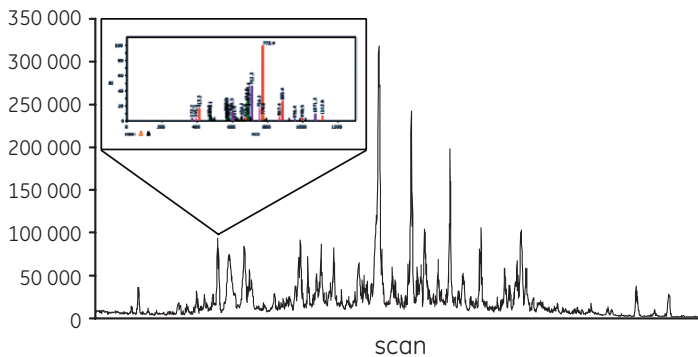
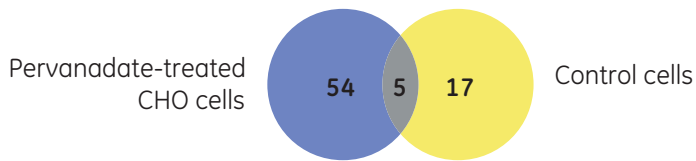

Fig 1.3. Number of identified pTy proteins in pervanadate-treated and control cells. A Base Ion chromatogram from a nano-LC-MS/MS run together with an MS/MS spectrum of a pTy peptide (the zoomed area) is shown. The peptide was identified as PTPn11.

Table 1.2. The first 20 pTy hits exclusively identified in the pervanadate-treated CHO cells

Protein	Total	M _r	Accession number
Protein tyrosine phosphatase	22	68.3	gi 458333
Caveolin-1	11	20.5	gi 603661
Beta-tubulin isotype I [<i>Cricetulus griseus</i>]	6	49.6	gi 473884
Cav1 protein [<i>Rattus norvegicus</i>]	1	19.7	(H) gi 124504347
AHNAK [<i>Mus musculus</i>]	6	224.0	gi 37675525
Focal adhesion kinase	8	119.1	gi 193224
Beta tubulin [<i>Cricetulus griseus</i>]	1	49.7	(H) gi 537407
Gamma-actin	1	41.8	(H) gi 309089
M1 pyruvate kinase [<i>Rattus norvegicus</i>]	5	57.8	gi 206204
Cortactin	5	61.2	gi 509495
M _r 47 000 heat shock protein [<i>Mus musculus</i>]	4	46.5	gi 303678
ABL2 [<i>Mus musculus</i>]	3	128.1	gi 68139002
Sorting nexin associated Golgi protein-1 (SNAG1) [<i>Mus musculus</i>]	4	67.9	gi 15559064
Polymerase I-transcript release factor (PTRF) [<i>Mus musculus</i>]	3	43.9	gi 2674195
Calmodulin synthesis	3	16.8	gi 192365
Beta-actin [<i>Marmota monax</i>]	1	32.0	(H) gi 9864780
Unnamed protein product [<i>Rattus norvegicus</i>], enolase 1	3	47.1	gi 56107
Eps8 binding protein [<i>Rattus norvegicus</i>]	3	51.7	gi 5882255
Chain B, Refined 1.8 Angstroms Resolution Crystal Structure Of Porcine Epsilon-Trypsin	3	8.8	gi 999627
Rous sarcoma oncogene [<i>Mus musculus</i>]	3	59.9	gi 123219085

Contaminant tolerance and analytical capabilities of selected techniques

ESI-MS

Electrospray ionization (ESI) is very susceptible to contamination. The sample should contain minimal amounts of buffers, salts, and detergents. Optimally, only water, organic modifier, and a volatile acid or base should be present. Buffers such as phosphate, Tris, and 4-(2-hydroxyethyl)-1-piperazineethanesulfonic acid (HEPES) cannot be used. Even traces of these buffers interfere with the ESI process. If buffers are needed, volatile buffers such as ammonium acetate can be used at a concentration ≤ 30 mM. Ionic detergents should be completely avoided, whereas useful data can be obtained by using certain nonionic detergents (nonionic saccharides such as n-dodecyl- β -D-glucopyranoside) at concentrations between 0.01% and 0.1% (12).

MALDI-MS

When compared with ESI, the matrix-assisted laser desorption ionization (MALDI) process is relatively tolerant to salts and small amounts of certain detergents (13). However, sensitivity and the quality of the data obtained are quite dependent on the purity of the sample. Best results are achieved if salts, buffers, and detergents are kept to a minimum. In Table 1.3, approximate tolerance levels for different contaminants are given. Also, any component present at a concentration above that of the matrix (~ 50 mM) might pose a problem.

Table 1.3. MALDI tolerance for common contaminants. Values should be viewed as approximate. Type of matrix, spotting technique, and combinatorial contaminants influence the exact tolerance (Table 16.2.1 from reference 14)

Contaminant	Maximum concentration
Sodium chloride	50 mM
Phosphate	10 mM
Tris base	50 mM
Urea	1 M
Guanidine	1 M
Azide	0.1% (v/v)
Glycerol	1% (v/v)
Polyethylene glycol (PEG) 2000	0.1% (w/v)
Sodium dodecyl sulfate (SDS)	0.01% (w/v)
Triton™ X-100, RTX-100, NP-40	0.1% (v/v)
Tween™	0.1% (v/v)
CHAPS	0.01% (w/v)
n-Octyl- β -glucopyranoside	1% (v/v)
Zwittergent™	0.1% (v/v)
Lauryldimethylamine oxide (LDAO)	1% (w/v)

Two-dimensional (2-D) gel electrophoresis

The first-dimension isoelectric focusing (IEF) step of 2-D electrophoresis is particularly sensitive to low-molecular-weight ionic impurities. Even relatively low concentrations of salts (< 5 mM) can slow down separation, prevent sharp focusing, or cause disturbances that result in poor-quality 2-D gel analysis results. Also, other nonprotein impurities in the sample can interfere with separation and subsequent visualization of the 2-D gel analysis results. Table 1.4 lists and discusses contaminants that affect 2-D gel analysis results negatively (15).

Table 1.4. Discussion of contaminants that affect 2-D gel electrophoresis negatively

Contaminant	Comments
Salts, residual buffers, and other charged small molecules that carry over from sample preparation	Salts disturb the electrophoresis process and must be removed or maintained at as low a concentration as possible. Salts in the immobilized pH gradient (IPG) strip result in high strip conductivity. Focusing of the proteins will not occur until the ions have moved to the ends of the strips, prolonging the time required for IEF. Water movement can also occur, causing one end of the strip to dry out and the other end to swell. Salt in the IPG strip can result in large regions at either end of the IPG strip where proteins do not focus (seen as horizontal streaking or empty regions in the final result). If the sample is rehydrated into the IPG strip, the salt concentration in the rehydration solution should be lower than 10 mM. If the sample is applied in sample cups, salt concentrations of up to 50 mM might be tolerated. However, proteins can precipitate at the sample application point as they abruptly move into a lower salt environment.
Endogenous small ionic molecules (nucleotides, metabolites, phospholipids, etc.)	Endogenous small ionic molecules are present in any cell lysate. These substances are often negatively charged and can result in poor focusing toward the anode. See also above.
Ionic detergent	Ionic detergents (usually SDS) are often used during protein extraction, but can strongly interfere with IEF. SDS forms complexes with proteins, and the resulting negatively charged complex will not focus unless the SDS is removed or sequestered.
Nucleic acids (DNA, RNA)	Nucleic acids increase sample viscosity and cause background smears. High-molecular-weight nucleic acids can bind to proteins through electrostatic interactions, preventing focusing. If the separated sample proteins are visualized by silver staining, nucleic acids present in the gel will also stain, resulting in a background smear on the 2-D gel.
Polysaccharides	Polysaccharides can clog gel pores causing either precipitation or extended focusing times, resulting in horizontal streaking. Some polysaccharides contain negative charges and can complex with proteins by electrostatic interactions.
Lipids	Many proteins, particularly membrane proteins, are complexed with lipids. This reduces their solubility and can affect both the pI and the molecular weight. Lipids form complexes with detergents, reducing the effectiveness of solubilization. When extracts of lipid-rich tissue are centrifuged, there is often a lipid layer that can be difficult to remove.
Phenolic compounds	Phenolic compounds are present in many plant tissues and can modify proteins through an enzyme-catalyzed oxidative reaction.
Insoluble material	Insoluble material in the sample can clog gel pores and result in poor focusing. Insoluble material is particularly problematic when the sample is applied using sample cups as it can prevent protein entry into the IPG strip.

1-D SDS-PAGE: Generally, to obtain clear, distortion-free bands of constant width, each loaded sample must have the same buffer and ionic composition.

Trypsin digestion: Trypsin is a serine protease with an optimal operating pH of 8 and an optimal operating temperature of 37°C. Trypsin predominantly cleaves proteins at the carboxyl end (or C-terminal end) of the amino acids lysine and arginine, except when these are followed by proline. Sequencing-grade trypsin is normally methylated (on the lysines) to prevent extensive autocatalysis. A volatile buffer is most often recommended: 50 mM NH_4HCO_3 (pH 7.8). Cleavage is generally faster and more complete in the presence of 1 M urea or up to 10% acetonitrile, whereas reducing agents will abolish the activity.

Chromatography: Contaminants can clog the pores of any chromatography medium. Specific contaminants affect different chromatography media differently, depending on the basis of separation. For example, salt can interfere with IEX, and detergents and lipids can hinder effective separation using HIC. When using any packed column, samples should be free of visible particulates to avoid pore clogging. This is especially true for GF, which separates molecules based on their size. Pass samples through a 0.45 or 0.5 μm filter to remove particulates (see Chapter 4; ensure that filters have low protein adsorption).

Analytical capabilities of protein analysis techniques

Global analysis of proteins is a complex and challenging task, mainly due to the large heterogeneity of chemical properties and the lack of general amplification techniques similar to the Polymerase Chain Reaction (PCR) for nucleic acids. However, a large number of both global and targeted techniques do exist for proteins. As stated earlier, the main focus in this handbook is on electrophoresis and MS-based techniques. Each of these main categories can be operated in both protein independent (2-D gel electrophoresis and global MS) and targeted (Western blots and targeted MS) modes. Brief descriptions of the techniques can be found in Appendix 1. A rough comparison of their analytical capabilities (without the aid of extensive sample preparation) related to expression analysis of proteins can be found in Table 1.5. Data for top-of-the-line affinity-based assays (i.e., bead-based protein arrays, proximity ligation assays, etc.) have been added for reference.

Table 1.5. Indications of analytical capabilities for selected categories of protein analysis techniques. Exact values can vary extensively depending on the specific equipment, protocol, and sample used

Technique	Dynamic range	Sensitivity	Resolving power/ multiplexing	References
2-D gel electrophoresis	10^2 – 10^3	10–100 ng/ml	~ 2–5000 proteins	(2, 3, 16, 17)
Global quantitative MS including RPC peptide separation	10^2 – 10^3	1–10 ng/ml	~ 1000 proteins	(2, 3, 18, 19)
Targeted quantitative MS including RPC peptide separation	10^4 – 10^5	0.1–1 ng/ml	~ 20–100 known proteins	(20–22)
Western blotting	10^3 – 10^4 *	10–100 pg/ml	A few known proteins	(23, 24)
Affinity-based assays	10^5 – 10^6 *	< 0.1 pg/ml	~10–100 known proteins	(25, 26)

* The values given indicate dynamic range for a single protein in an assay. By making adjustments (e.g., adjusting antibody dilutions), global dynamic range can be extended so that any protein from the sensitivity limit upward can be measured (at least in a single-plex mode).

References

- Ghaemmaghami, S. *et al.*, Global analysis of protein expression in yeast. *Nature* **425**, 737–741 (2003).
- Eriksson, J. and Fenyő, D. Improving the success rate of proteome analysis by modeling protein-abundance distributions and experimental designs. *Nat. Biotechnol.* **25**, 651–655 (2007).
- Ali-Khan, N. *et al.* Overview of proteome analysis, in *Current Protocols in Protein Science*, John Wiley and Sons, Inc., New York. 22.1.1–22.1.19, supplement 30 (2002).
- Anderson, N. L. and Anderson, N. G. The human plasma proteome: history, character, and diagnostic prospects. *Mol. Cell. Proteomics* **1**, 845–867 (2002).
- Bodzon-Kulakowska, A. *et al.* Methods for samples preparation in proteomic research. *J. Chromatogr.* **849**, 1–31 (2007).

6. Rifai, N. *et al.* Protein biomarker discovery and validation: the long and uncertain path to clinical utility. *Nat. Biotechnol.* **24**, 971-983 (2006).
7. Svensson, M. *et al.* Heat stabilization of the tissue proteome: a new technology for improved proteomics. *J. Proteome Res.* **8**, 974-981 (2009).
8. Bodzon-Kulakowska, A., *et al.*, Methods for samples preparation in proteomic research, *J. Chromatogr. B*, **849**, 1-31 (2007).
9. Granger, J. *et al.* Albumin depletion of human plasma also removes low abundance proteins including the cytokines. *Proteomics* **5**, 4713-4718 (2005).
10. Liu, T. *et al.* Evaluation of multiprotein immunoaffinity subtraction for plasma proteomics and candidate biomarker discovery using mass spectrometry. *Mol. Cell. Proteomics* **5**, 2167-2174 (2006).
11. Hunter, T. The Croonian Lecture 1997. The phosphorylation of proteins on tyrosine: its role in cell growth and disease. *Philos. Trans. R. Soc. Lond. B. Biol. Sci.* **353**, 583-605 (1998).
12. Ogorzalek Loo, R. R. *et al* Surfactant effects on protein structure examined by electrospray ionization mass spectrometry. *Protein Science* **3**, 1975-1983 (1994).
13. Cohen, S. L. and Chait, B. T. Influence of matrix solution conditions on the MALDI-MS analysis of peptides and proteins. *Anal. Chem.* **68**,31-37 (1996).
14. Jiménez, C.R. *et al.*, Sample Preparation for MALDI Mass Analysis of Peptides and Proteins, *Curr. Protoc. Protein Sci.*, **Unit 16.3**, 10.1002/0471140864.ps1603s14 [Online] 1 May 2001.
15. Berkelman, T. Removal of interfering substances in samples prepared for two-dimensional (2-D) electrophoresis. *Methods in Molecular Biology* **424** Humana Press, New Jersey, pp 51-62 (2008).
16. Görg, A. *et al.* Current two-dimensional electrophoresis technology for proteomics. *Proteomics* **4**, 3665-3685 (2004).
17. *2-D Electrophoresis: Principles and Methods*, GE Healthcare, 80-6429-60 Edition AD (2010).
18. Wysocki V. H. *et al.* Mass spectrometry of peptides and proteins. *Methods* **35** 211-222 (2005).
19. Domon, B. and Aebersold, R. Mass spectrometry and protein analysis. *Science* **312**, 212-217 (2006).
20. Pan, S. *et al.* Mass spectrometry based targeted protein quantification: methods and applications. *J. Proteome Res.* **8**, 787-797 (2009).
21. Brun, V. *et al.* Isotope dilution strategies for absolute quantitative proteomics. *J. Proteomics* **72**, 740-749 (2009).
22. Picotti, P. *et al.* Full dynamic range proteome analysis of *S. cerevisiae* by targeted proteomics. *Cell* **138**, 795-806 (2009).
23. Kurien, B. T. *et al.* Protein blotting: a review. *J. Immunol. Methods* **274**, 1-15 (2003).
24. Application note: Multiplex protein detection using the ECL Plex™ fluorescent Western blotting system, GE Healthcare, Edition 28-4015-40 AB (2005).
25. Fredriksson, S. *et al.* Multiplexed protein detection by proximity ligation for cancer biomarker validation. *Nat. Methods* **4**, 327-329 (2007).
26. Joos, T. O. *et al.* Protein microarray technologies: an array of applications, in *Optical Biosensors: Today and Tomorrow 2nd Edition* (Ligler, F. S. and Taitt, C. R. eds.), Elsevier, Oxford (2008).

Chapter 2

Sample collection, stabilization, and protein extraction

Introduction

The first interrelated steps in any protein analysis workflow include the collection of a well-defined sample specimen, followed by stabilization and extraction of the protein population relevant to the analytical purpose (Fig 2.1). These steps are the focus of this chapter. The purpose is to move all the targeted protein population—while preserving the *in vivo* state—from the initial biological source into a homogeneous solution. Any bias introduced during these steps cannot be compensated for, regardless of the sophistication and performance of additional sample preparation and analytical techniques.

Due to the large chemical/physical heterogeneity of both proteins and their sample sources, no universal set of protocols exists. Methods need to be adjusted based on sample source, the analytical purpose, and technique. The level of manipulation needed at this stage also varies greatly. At one end, body fluids such as urine or plasma are already more or less homogeneous protein solutions with low enzymatic activity, and they require only minor adjustments after collection. At the other end, tissue samples require extensive manipulations to break up tissue architecture, control enzymatic activity, and solubilize proteins. The intent of this chapter is to provide an overview of important methodology and considerations together with specific examples of relevant products and protocols. A closely related and sometimes integrated objective is the removal of nonprotein contaminants (nucleic acids, lipids, polysaccharides, phenols, etc.) present in the sample sources used. Some aspects, such as nuclease treatment to reduce the size of DNA, are covered here, but the subject is mainly covered in Chapter 4.

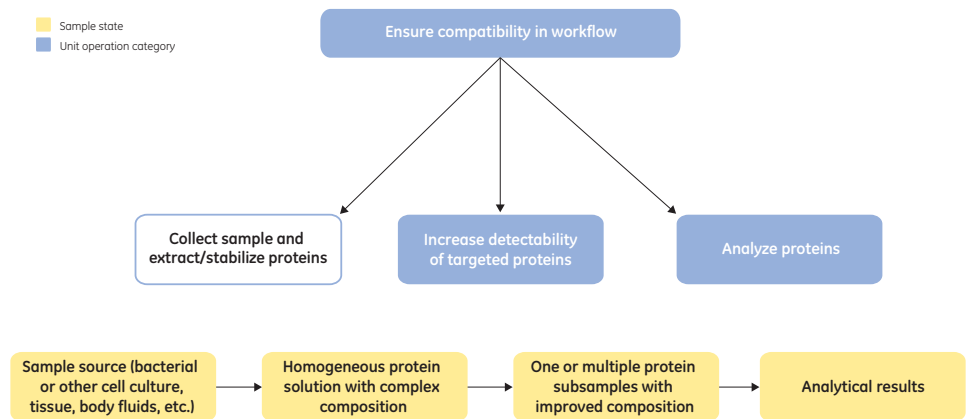

Fig 2.1. High-level workflow for protein sample preparation and analysis. The unit operation category discussed in this chapter is framed.

In addition to uniform and high-yield extraction of targeted proteins, the quality of the isolated proteins is also an important consideration. Quality refers to the physical form of the isolated proteins. As outlined in Chapter 1, protein modifying enzymes are often activated and released during sample collection and protein extraction. If not controlled, they can cause degradation and alter PTMs. Degradation and chemical modifications can also be induced by the conditions used in sample preparation operations. Because relatively harsh conditions are often needed

to break tissue/cell architecture and solubilize proteins, induced modifications are of special concern at this stage. Aside from the requirement for intact protein, some workflows require that proteins are functionally active or at least retain their 3-D structure.

Overview of steps to prepare a protein extract

Directly at or after sample collection, there is an onset of processes that will begin to degrade or alter the proteome, as discussed in Chapter 1. There must be a strategy to cope with the deteriorating proteome, possibly including one or more of the following processes:

- Immediate freezing of sample in liquid nitrogen
- Chemical- and/or temperature-induced denaturation of proteins (including modifying enzymes)
- Addition of protective or stabilizing compounds (reducing agents, enzyme inhibitors, etc.)
- Stabilization or inactivation of proteins by precipitation
- Working quickly and keeping samples cold during processing

Next, there is a need to solubilize the proteins using a suitable buffer to control the pH and other additives that enhance solubility of proteins and are compatible with later processes. Depending on the sample, homogenization and cell disruption using one of the techniques in Table 2.1 might be required. A kit-based protocol for small-scale homogenization of tissue samples follows Table 2.1.

Additional general considerations include time of exposure to extraction buffer/solvent and the ratio of solubilization agent to protein.



Keep the sample preparation strategy as simple as possible to avoid protein losses. Additional sample preparation steps can improve the quality of the final experimental result, but at the possible expense of selective protein loss.

The following steps will be discussed in greater detail in this chapter. Note that protein stabilization and solubilization often occur concurrently with breaking up cellular and tissue architecture.

- Sample collection
- Breaking up cellular and tissue architecture
 - Subcellular fractionation
- Stabilization of proteins against:
 - Hydrolysis by proteases and phosphatases
 - Oxidation
 - Conformational destabilization
- Solubilization of proteins
- Clarification of protein extract
- Protein quantitation

Sample collection

Sample collection, or sampling, is the process of extracting a defined portion of the biological system to be analyzed. A multitude of sample sources exist, but the most important biological model systems can be found among mammalian cell cultures, tissues, or body fluids. For recombinant protein expression, different cell cultures (bacteria, yeast, insect, or mammalian cells) are the most common sources. Hybridoma cells are a source of monoclonal antibodies (MAbs).

Breaking up cellular and tissue architecture

To extract proteins from cells and tissue, the architecture needs to be broken up so that proteins or subcellular components are accessible for manipulation. Extraction is further dependent on the concurrent action of a solution with suitable additives to release and solubilize all targeted proteins. The need to stabilize proteins should also be carefully considered at or before extraction. The latter objectives are covered separately below. Methods available to achieve the first objective can be roughly divided into gentle lysis methods, moderate methods, or vigorous homogenization and cell disruption methods (Table 2.1). In lysis methods, cells are generally only perforated or partly ruptured, leaving parts of the architecture intact. In contrast, the more vigorous methods tend to achieve more or less full homogenization of the sample (absence of higher-order structure).



Monitor the effectiveness of the disruption method by closely inspecting the lysate, looking for particulate matter. For stringent downstream analyses, remove all particulate material by filtration (see “Clarification of protein extract,” below) or centrifugation/ultracentrifugation. For example, solid particles and lipids must be removed prior to 2-D electrophoresis because they will block the gel pores.



Disrupt the cells or tissue in such a way as to minimize proteolysis and other modes of protein degradation. Cell disruption should be performed at as low a temperature as possible and should avoid heat generation. Often, carrying out cell disruption in a solution containing protease inhibitors will give good results.



Prepare the sample just prior to the analysis (or store samples in aliquots at -80°C) to preserve sample quality.



Do not expose protein solutions to repeated freeze/thawing.

The design of this step is highly dependent on whether or not subcellular fractionation will be applied. As outlined in Chapter 1, current analytical technologies are insufficient to handle the large complexity of biological samples without some sort of simplification. One possible route is to restrict the extent of analysis by focusing on subcellular structures such as organelles (nuclei, Golgi, mitochondria, endoplasmic reticulum, etc.).

Subcellular fractionation

In subcellular fractionation, protein extraction becomes a multistep procedure. First, cells from culture or tissue need to be lysed to release their organelles. In general, the method needs to be very gentle to minimize disruption of organelles. Once the cells have been opened, the components of interest are generally roughly purified by differential centrifugation in, for example, density gradient media. The resulting fractions often contain significant amounts of contaminating components, so further fractionation is generally advisable, although the overall yields might be lowered. Available methods for these purifications include free-flow electrophoresis and immunopurification. Finally, proteins are extracted from purified organelles in a similar manner as for cells. For more detailed guidance, refer to reference 1.

Table 2.1. Homogenization and cell disruption methods

Extraction process	Mechanism	Typical conditions	Sample source	Comments
Gentle				
Cell lysis (osmotic shock)	Very gentle method suitable for fractionation of subcellular organelles.	Add two volumes water to one volume packed, prewashed cells.	Erythrocytes, <i>E. coli</i> (periplasmic proteins).	Reduced protease release, but lower seed product yield.
Enzymatic digestion	Enzymes remove cell walls.	Add lysozyme at 0.2 mg/ml.	Good for Gram-positive bacteria. For Gram-negative bacteria (e.g., <i>E. coli</i>), combine with detergent and/or osmotic shock lysis.	Often combined with mechanical disruption.
Detergent lysis	Detergents solubilize cellular membranes.	Suspend cells in lysis solution containing detergent.	Eukaryotes, <i>E. coli</i> .	
Manual homogenization	Use a handheld homogenizer or a blender to physically break up tissue and cells.	Chop tissue into small pieces first, if necessary. Add chilled homogenization buffer (3–5 vol/vol tissue). Homogenize briefly. Clarify lysate by filtration and/or centrifugation.	Liver tissue, etc.	Homogenization is rapid. Poses little danger for proteases except by the proteases that might be released upon disruption.
Grinding	Grind with mortar and pestle.	Freeze in liquid nitrogen and grind to a fine powder.	Muscle tissue, etc.	
Moderate				
Blade homogenizer		Follow equipment instructions.	Muscle tissue, most animal tissue, plant tissue.	
Grinding with abrasive, e.g., glass beads	The abrasive actions of vortexed beads break cell walls, liberating cellular contents.	Add 1–3 g of glass beads per gram of prewashed cells, vortex, chill, centrifuge, repeat up to five times, pooling supernatants.	Bacteria, plant tissue.	Physical method. Chemical conditions are less important for cell lysis but can be important for subsequent removal of cell debris and for purification steps.
Freeze/thaw	Cells are subjected to one or more cycles of quick freezing and subsequent thawing.	Freeze cells, thaw (repeat several times), resuspend pellet by pipetting or gentle vortexing in room-temperature in lysis buffer. Incubate, centrifuge, retain supernatant.		Several freeze/thaw cycles can affect the integrity of the proteins.
Vigorous				
Ultrasonication or bead milling	Ultrasonic waves disrupt cells through shear forces.	Sonicate cell suspension in appropriate buffer using short bursts to avoid heating. Cool on ice between bursts.	Cell suspensions: intracellular proteins in cytoplasm, periplasm, inclusion bodies.	Release of nucleic acids can cause viscosity problems; if so, add deoxyribonuclease (DNase). Inclusion bodies must be resolubilized.
French press	Cells are disrupted by shear forces resulting from forcing cell suspension through a small orifice under high pressure.	Place cell suspension in chilled French pressure cell. Apply pressure and collect extruded lysate.	Bacteria, plant cells.	

Kit-based sample grinding

Sample Grinding Kit from GE Healthcare is designed for the grinding of small tissue or cell samples (100 mg or less) for protein extraction. The kit consists of fifty 1.5 ml microcentrifuge tubes each containing a small quantity of abrasive grinding resin suspended in water. Fifty pestles for sample grinding are also supplied. To begin the protocol (Fig 2.2), centrifuge the tube to pellet the resin and remove the water, then add an extraction solution of choice along with the sample to be ground. After the sample is ground with a disposable pestle, cellular debris and grinding resin are removed by centrifugation. Sample Grinding Kit will effectively grind most animal and plant tissues. Intracellular organelles are also disrupted, resulting in the liberation and extraction of all proteins soluble in the extraction solution. A brief protocol is provided below. See product instructions for a detailed protocol.

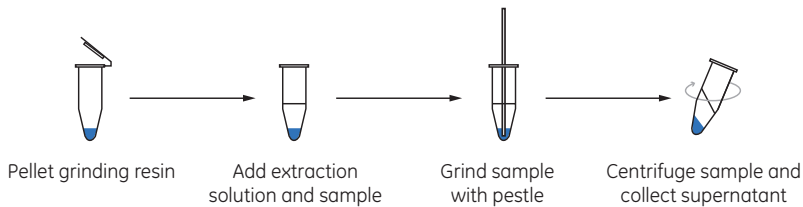

Fig 2.2. Sample disruption using Sample Grinding Kit.

Materials

Pestles and Grinding Tubes (microcentrifuge tubes containing grinding resin) are provided with the product.

Extraction solution/buffers of choice¹

Advance preparation

The tissue of interest may be sliced with a scalpel to appropriately sized fragments; alternatively the tissue may be frozen with liquid nitrogen and broken into small fragments by a pestle. Sample grinding is easier if the tissue is minced prior to adding to the grinding tube.

¹ GE Healthcare provides a range of extraction buffers. See below.

Protocol

1. Pellet grinding resin
Centrifuge one or more grinding tubes briefly at maximum speed to pellet the grinding resin. Remove liquid.
2. Add extraction solution and sample
Add extraction solution of choice to the grinding tube and vortex. Add tissue or cells. The extraction buffer and additives should solubilize the target proteins and protect against chemical and/or enzymatic activity as previously discussed.
3. Grind sample with pestle to disrupt cells/tissue
Use a pestle to thoroughly grind the sample. Add more extraction solution if needed.
4. Centrifuge sample and collect supernatant
Centrifuge the tube at maximum speed to remove resin and cellular debris. Carefully transfer the clear supernatant to another tube. The extract is now ready for further cleanup or analysis by SDS-PAGE, 2-D electrophoresis, or other means.

Stabilization of proteins

Protein lifetimes range from seconds (hormones) to years (collagen). The stability and thereby the quality of protein extracts is limited by enzymatic activity (proteases and other protein modifying enzymes) as well as deleterious chemical reactions and conformational changes (denaturation) induced during handling.

Table 2.2 is an overview of possible protein modifications. Destabilization can be reversible or irreversible. Further details about some of the commonly occurring modifications are discussed below.

Table 2.2. Destabilizing chemical reactions and effects on protein stability *in vitro*

Chemical (covalent) modifications

Modification	Comment
Hydrolysis	For example, proteolysis
Oxidation	Especially Met, Trp, and His residues
Deamidation	Asn, some Gln residues
β -elimination	Asp residues
Isopeptide formation	Amide bond between Lys and Glu or Asp side chains
Racemization	Conversion of L-amino acids to D-form (slow reaction)
S-S interchange and/or thiol/S-S exchange	Cys-bridges
Maillard reaction	Amino acid amine reaction with reducing sugar

Conformational (noncovalent) modifications: Unfolding/denaturation/aggregation

Protonation/deprotonation	pH extremes
Solvation of hydrophobic core	For example, by detergents
Transfer of water to hydrophobic core	For example, pressure
Shear force	For example, by mixing, flow in tubes, or UF
Transfer of nonpolar residues to the surface	For example, by high temperature
Repulsive or attractive intramolecular salt bridges	Divalent metal ions
Lyotropism	Salting-in

Unless very stable proteins are to be studied, there is a need to quickly stabilize a sample specimen after collection. Freeze/thawing and homogenization of a sample bring all proteins together unordered, which means that modifying enzymes come in contact with proteins that were previously separated in space and in different cell compartments. The strategy is simple: reduce all enzymatic activity and keep all modifications to a minimum. In practice, however, this is a real challenge. It is important to decide whether or not the proteins need to retain their conformation. Enzymatic activity can be stopped quickly by denaturation of all proteins in a sample, for example, by quick heating, but it might not be possible to return the proteins to their active native state later. Working with native proteins normally requires use of gentle extraction methods combined with chemical compounds that inhibit detrimental enzymatic activity.

Protection against hydrolysis

Nonenzymatic hydrolysis of the peptide bonds in proteins requires heating of the sample in the presence of a strong acid such as hydrochloric acid for a prolonged time (e.g., for amino acid analysis). During sample preparation, there might be some limited nonenzymatic peptide hydrolysis, facilitated at Asp-Pro bonds at pH 2 or below (2). Otherwise, the major cause of peptide hydrolysis in proteins is due to the action of proteases (also known as peptidases or peptide hydrolases). Proteases occur naturally in all organisms. Exopeptidases act only near the ends of a polypeptide chain whereas endopeptidases are divided into sub-subclasses on the basis of catalytic mechanism.

Examples of proteases include:

Exopeptidases

- Aminopeptidases (e.g., alanine aminopeptidase)
- Dipeptidyl peptidases (e.g., cathepsin C)

Endopeptidases

- Serine proteases (e.g., chymotrypsin)
- Cysteine proteases (e.g., papain)
- Aspartic acid proteases (e.g., penicillopepsin)
- Metallo endopeptidases (e.g., thermolysin)

Featured inhibitors of the members of each catalytic type of protease exist; some examples are shown in Table 2.3. See references 3, 4, and 5 for further reading.

Another important reaction involving hydrolysis is the reversible phosphorylation of serine, threonine, and tyrosine residues. The phosphorylation-dephosphorylation is tightly controlled by the opposing action of protein kinases and phosphatases, respectively. Phosphatases are of special concern when preparing samples for detection of phosphorylated proteins and peptides. There are two superfamilies of phosphatases, Ser/Thr and Tyr phosphatases, and they can be chemically inhibited, preferably by a mix of different compounds. Salts of vanadate, molybdate, tartrate, imidazole, and okadaic acid, etc., inhibit various classes of phosphatases.

Table 2.3. Examples of protease and phosphatase inhibitors¹**Protease inhibitors²**

Inhibitor	Working concentration	Target	Comments
Phenylmethylsulfonyl fluoride (PMSF) ³	0.5–1 mM	Inhibits serine proteases and some cysteine proteases	PMSF is an irreversible inhibitor that inactivates serine and some cysteine proteases. PMSF is rapidly inactivated in aqueous solutions. Prepare just prior to use. Less effective in the presence of thiol reagents. PMSF is very toxic.
Aminoethyl benzylsulfonyl fluoride (AEBSF)	up to 4 mM	Inhibits serine proteases	More soluble and less toxic than PMSF. Induces modifications that can potentially alter the pI of a protein, which could affect 2D-PAGE and MS analysis.
4-Aminophenyl-methylsulfonyl fluoride (APMSF)	0.4–4 mM	Inhibits serine proteases	
EDTA	2–10 mM	Inhibits metal-dependent proteases, zinc, and iron	Inhibits nucleases by binding Mg ²⁺ added to break down nucleic acids in viscous samples.
EGTA	2–10 mM	Inhibits metal-dependent proteases, e.g., calcium	Does not bind Mg ²⁺ , thus does not inhibit nucleases.
Pepstatin	1 μM	Inhibits aspartic proteases	Can interfere with protein analysis.
Leupeptin	10–100 μM	Inhibits cysteine and serine proteases	Can interfere with protein analysis.
Chymostatin	10–100 μM	Inhibits chymotrypsin, papain, cysteine proteases	Can interfere with protein analysis.
Antipain-HCl	1–100 μM	Inhibits papain, cysteine and serine proteases	
Tosyl lysine chloromethyl ketone (TLCK), tosyl phenylalanine chloromethyl ketone (TPCK)	0.1–0.5 mM	Inhibits serine and cysteine proteases	Irreversible inhibition.
Benzamidine-HCl	0.2 mM	Inhibits serine proteases	
Phosphatase inhibitors			
Sodium orthovanadate	0.4–0.5 mM	Inhibits phosphotyrosyl phosphatases (PTPs)	Competitive inhibition. The inhibition by vanadate is completely reversible upon the addition of EDTA or by dilution.
Calyculin A	50–100 nM	Inhibits serine and threonine phosphatases	

¹ Details taken from references 6 and 7, and other sources² Protease inhibitors are available in premade mixes from several suppliers³ PMSF is a hazardous chemical. Half-life time in aqueous solution is 35 min. PMSF is usually stored as a 10 mM or 100 mM stock solution (1.74 or 17.4 mg/ml) in isopropanol at –20°C

Protease inhibition using Protease Inhibitor Mix

GE Healthcare offers Protease Inhibitor Mix, which is a combination of competitive and noncompetitive protease inhibitors that inhibit serine, cysteine, and calpain proteases. Protease Inhibitor Mix effectively inhibits over 95% of protease activity and protects proteins from proteolysis during preparation from animal tissues, plant tissues, yeast, and bacteria. The cocktail was specifically developed for sample preparation in 2-D electrophoresis studies, but it can be used more broadly. EDTA may be optionally added to inhibit metalloproteases; it should, however, be kept in mind that the absence of EDTA allows optimal nuclease activity, which removes nucleic acids from samples. Therefore, if nucleases will be added to the protein sample, use EGTA instead of EDTA because it does not chelate the Mg^{2+} that is required for nuclease activity.

Materials

Protease Inhibitor (100× solution) is provided with the product.

Advance preparation

None

Protocol

1. Allow the solution to warm to room temperature.
2. The solution is in suspension form. Vortex briefly before using.
3. Dilute Protease Inhibitor 1:100 (10 μ l/ml) in an appropriate volume of extraction buffer or extract.¹

¹ GE Healthcare provides a range of extraction buffers. See below.

Further options

- If a high potency of protease inhibition is required, add Protease Inhibitor at a concentration of 20 to 30 μ l/ml to get a 2× to 3× final concentration.
- For the inhibition of metalloproteases, add EDTA directly in an appropriate volume of extraction buffer or extract to give a final concentration of 5 mM EDTA in the reaction.



Do not add EDTA if the solution is to be used in conjunction with Nuclease Mix, as EDTA acts as a nuclease inhibitor. Use, for example, EGTA instead.

Protection against oxidation

Naturally occurring oxidases have important functions *in vivo*, for example, for oxidation of -SH groups to generate disulfide bonds or hydroxylation of Pro, Lys, and Asn residues in collagen. Oxidation is often directly or indirectly mediated by free radicals and can be catalyzed by transition metal ions. Iron (II) and copper(II) salts will slowly oxidize in the presence of oxygen and water to form reactive oxygen species that can attack any amino acid side-chain of a protein in a sample. There are a few amino acid residues that are preferentially targeted by metal-ion-catalyzed oxidation: His, Met, Cys, and Trp (8).

One common example of protein oxidation occurs during electrophoresis. Reactive oxygen species can be generated during electrophoresis especially when using nondegassed acrylamide solutions (9). The resulting oxidation can be detected as a mass shift (+ M, 16) in peptides after enzymatic digestion and MS analysis. An oxygen species scavenger such as thioglycolate may be added to the cathode buffer to minimize such artifactual oxidation reactions.

Cys residues can produce mixed disulfides when oxidizing, producing internal or external disulfide bonds resulting in protein aggregation. Reducing agents can be added to the buffers to prevent the formation of mixed disulfides (e.g., 1 mM DTT), often together with metal ion chelators that bind transition metal ions (e.g., 0.5 mM EDTA).

Disulfide bonds can also be broken by an excess of reducing agents. Several compounds can be used to achieve this reduction (Table 2.4).



Table 2.4. Reducing agents

Reducing agent	Working concentration	Stock solution	Comments
1,4 dithiothreitol (DTT) (Cleland's reagent) or alternatively 1,4 dithioerythritol (DTE)	< 100 mM	1 M in water, store at -20°C (1 yr).	Only effective above pH 7. Susceptible to air oxidation. Oxidized form gives increase in absorbance at 280 nm.
β-mercaptoethanol (BME)	> 0.2 M	1 M in water, store in dark at 4°C (1 yr).	Susceptible to air oxidation, volatile, unstable in aqueous solution above pH 5, higher pH further decreases stability. Sensitive to presence of metal ions. Stabilize by adding EDTA.
TCEP (purchase as TCEP-HCl)	2–10 mM	0.5 M in water adjusted to suitable pH. Store at -20°C. TCEP dissolved in water is acidic. TCEP is less stable in phosphate buffers.	Stable to air oxidation. More efficient than DTT below pH 8. Does not affect metal ions during immobilized metal ion affinity chromatography (IMAC). Readily soluble, max. 1.1 M, stable in aqueous solution, stable in acidic and basic solution. Odorless, thiol-free, pH range 1.5–9. TCEP can reduce DTT.

Reoxidation can be prevented by alkylation of the free thiols with IAA, vinylpyridine, or acrylamide, or by keeping a small amount of reducing agent throughout the workflow, for example, 1 mM DTT in all subsequent buffers.

Protection against conformational destabilization

Protein structure defines its function. The tertiary and quaternary structure of a protein affects its function and stability. These structures are governed by the intrinsic amino acid sequence, PTMs, and binding of cofactors, as well as by factors in the surrounding microenvironment. Operations and additives used during sample preparation can induce denaturation or aggregation of proteins. Examples of destabilizing conditions are shown in Table 2.2.

-  General advice is to control the destabilizing forces during sample preparation; examples include changes in pH, temperature, and ionic strength.
-  Other important factors that are more difficult to control include shear forces and pressure; these should be minimized by gentle treatment of the samples (especially under native conditions), for example, by avoiding excessive mixing or shaking.
-  Protein adsorption to surfaces can also cause denaturation (10), but this can be controlled by surface modification (e.g., siliconization) or by adding excipients such as detergents that have a higher surface activity than proteins.

Solubilization of proteins

Biological samples are in general highly complex in their protein composition. Cells, for example, express up to 20 000 proteins that differ in their cellular and subcellular distribution, molecular mass, and hydrophobicity. The proteins are expressed at different levels and with various PTMs. Cells contain proteins that are either bound in complexes or to the various cell components. Cytoplasmic proteins are high in solubility and can simply "float" through the cell cytoplasm.

The solubilization of any protein mixture is of major importance since it affects the overall performance of the final analysis. The aim with global protein preparation is to solubilize as many target proteins as possible with a high reproducibility to achieve optimal results. When working with recombinantly produced proteins, the main purpose is often to obtain high accumulation of soluble proteins while minimizing the solubility of contaminants with maintained reproducibility.

Most often, all interactions with other proteins, lipids, or nucleic acids also need to be disrupted for a complete solubilization (except when the actual aim is to study interactions). The chosen solubilization strategy should be compatible with other steps in the sample preparation workflow. It can sometimes be crucial to keep the proteins in their natively folded state, if the aim is to perform an analysis based on functionality or for compatibility with other steps in the workflow. However, native protein extraction inevitably compromises extraction efficiency. Efficient extraction is partly dependent on breaking protein interactions to release proteins bound in macromolecular assemblies. The maximum solubilization, including the breaking of protein interaction, sometimes results in denaturing of the protein.

A successful preparation of a protein extract includes complete release of soluble proteins from the source material in a form that is compatible with the next step(s) in the workflow while avoiding unwanted chemical or conformational degeneration. If the protein source is cells or tissue, the preparation involves homogenization, solubilization, and stabilization.

These steps are preferably executed simultaneously, involving the choice of disruption method, extraction buffer, and a strategy to avoid modification of the proteins. The extraction procedure should be executed in the exact same way for all samples in the experimental series.

Solubility is governed by some of the factors that stabilize/destabilize proteins (Table 2.2). Apart from temperature and hydration, the major solubilizing factors depend on electrostatic, hydrophobic, and hydrogen bonding interactions.

Table 2.5. Commonly used buffer substances

Common name	pK _a (25°C)	Buffer range	ΔpK _a /°C
Phosphate ¹	2.11		
Glycine	2.39		
Citric acid ¹	3.13	2.6-3.6	-0.0024
Formic acid	3.75	3.8-4.3	0.0002
Lactic acid	3.8		
Gamma-aminobutyric acid (GABA)	4.07		
Acetic acid	4.76		
Propionic acid	4.83		
Histidine	6.04		
2-(N-morpholino)ethanesulfonic acid (MES)	6.1	5.5-6.7	-0.011
Bis-Tris	6.5	5.8-7.2	
N-(2-Acetamido)iminodiacetic acid (ADA)	6.59	6.0-7.2	
Piperazine-1,4-bis(2-ethanesulfonic acid) (PIPES)	6.76	6.1-7.5	-0.008
N-(2-Acetamido)-2-aminoethanesulfonic acid (ACES)	6.78	6.1-7.5	
3-(N-Morpholino)-2-hydroxypropanesulfonic acid (MOPSO)	6.9	6.2-7.6	
Phosphate ²	6.95		
N,N-Bis(2-hydroxyethyl)-2-aminoethanesulfonic acid (BES)	7.09	6.4-7.8	
3-(N-morpholino)propanesulfonic acid (MOPS)	7.2	6.5-7.9	-0.015
N-Tris(hydroxymethyl)methyl-2-aminoethanesulfonic acid (TES)	7.4	6.8-8.2	-0.020
4-(2-hydroxyethyl)-1-piperazineethanesulfonic acid (HEPES)	7.55	6.8-8.2	-0.014
Triethanolamine	7.76	7.3-8.2	
3-[4-(2-hydroxyethyl)-1-piperazinyl]propanesulfonic acid (EPPS)	8	7.3-8.7	
Tricine	8.05	7.4-8.8	-0.021
Tris	8.06	7.5-9.0	-0.028
Glycylglycine	8.21	7.5-8.9	
Bicine	8.35	7.6-9.0	-0.018
N-Tris(hydroxymethyl)methyl-3-aminopropanesulfonic acid (TAPS)	8.43	7.7-9.1	-0.018
Morpholine	8.6		
Taurine	9.02		
Boric acid	9.2		
N-Cyclohexyl-2-aminoethanesulfonic acid (CHES)	9.49	8.6-10.0	
Ethanolamine	9.54		
3-(Cyclohexylamino)-2-hydroxy-1-propanesulfonic acid (CAPSO)	9.6	8.9-10.3	
Piperazine	9.73		
Glycine	9.74		
N-cyclohexyl-3-aminopropanesulfonic acid (CAPS)	10.4	9.7-11.1	

¹ pK_{a1}² pK_{a2}

Detergents

Protein solubility can be further increased by additives. Detergents (or surfactants, tensides) are amphiphatic molecules consisting of both a polar or ionic group (head-group) and a hydrocarbon chain (tail). In an aqueous solution, the hydrophilic head forms dipole-dipole or ion-dipole interactions with water molecules, while the hydrophobic tails aggregate, resulting in spherical structures called micelles. These properties allow detergents to be soluble in water and to solubilize hydrophobic compounds. In low concentrations, the detergent molecules exist individually, but above a certain concentration (the critical micellar concentration, CMC), micelles are formed. Micelles consist of pure detergent or a mixture of detergents, lipids, and/or proteins (mixed micelles). CMC for a particular detergent depends on the intrinsic properties of the molecule, ionic strength, and temperature, for example.

The classification of detergents normally refers to the nature of the head-group. Some examples are:

- Anionic detergent (SDS)
- Cationic detergent (Cetyltrimethylammonium bromide [CTAB])
- Nonionic detergent (Octyl glucoside)
- Zwitterionic detergent (CHAPS)

The hydrocarbon chain is linear or branched and is referred to as flexible or rigid.

The choice of detergents for protein solubilization is almost unlimited; some commonly used detergents are shown in Table 2.6. The appropriate detergent should:

- Give maximum yield of target proteins in the soluble fraction
- Be soluble in buffer solutions at the working temperature
- Be easily removed later in the workflow (if necessary)
- Preserve the biological activity of the protein (if necessary)
- Not introduce unwanted protein modifications
- Not interfere with analysis (e.g., detection by UV or MS)
- Not interfere with other steps in the workflow

SDS, for instance, is known to solubilize almost any protein at a ratio of 1.4 g of SDS/g of protein (13). SDS denatures and inactivates most proteins and enzymes, including proteases. It is widely used for electrophoresis (SDS-PAGE) and Western blotting. However, SDS is not suitable for functional studies since it denatures proteins, nor is it suitable for analysis with RPC due to interference with the medium.

Table 2.6. Some commonly used detergents in protein work

Nonionic detergents	M_r (anhydrous)	CMC² (mM)	Average micellar weight (M_w)
Brij™-35	1199.6	0.09	48 000
Digitonin	1229.3	-	7000
MEGA-8	321.5	58	-
Nonidet™ P-40 ¹	306	0.25	-
n-Nonyl-β-D-glucopyranoside	306.4	6.5	-
n-Octyl-β-D-glucopyranoside	292.4	20–25	25 000
n-Octyl-β-D-maltopyranoside	454.5	23.4	38 000
Triton X-100 ¹	625 (avg.)	0.2–0.9	80 000
Triton X-114	537 (avg.)	0.35	-
TWEEN 20	1228 (avg.)	0.059	-
TWEEN 80	1310 (avg.)	0.012	76 000
Zwitterionic detergents			
CHAPS	614.9	6–10	6150
CHAPSO	630.9	8	7000
Zwittergent 3–10	307.6	25–40	12 500
Zwittergent 3–12	335.6	2–4	18 500
Ionic detergents			
Cetyltrimethylammonium bromide (CTAB)	364.5	1	62 000
Cholic acid, sodium salt	430.6	9–15	900
Deoxycholic acid, sodium salt	414.6	2–6	1200–4900
Lauroylsarcosine, sodium salt	293.4	-	600
SDS	288.4	7–10	18 000

¹ *Nonidet P-40, IGEPAL CA-630, and Triton X-100 are liquid detergents of similar structure and average formula weight*

² *Temperature: 20°C to 25°C*

The first step in choosing a detergent involves a survey of the literature for finding appropriate candidates. Next, the choice of detergent in the initial step of solubilization is often made on an empirical basis; this involves random testing of a number of detergents and assaying for yield of the protein(s) of interest. The concentration of the detergent and the detergent/protein ratio is then important, and during solubilization an excess of, for example, 2 to 3 times the amount of detergent compared with protein (and lipids) should be used. It is important to work with the highest-quality “protein-grade” detergents to prevent artifacts and protein modifications. Detergents with polyoxyethylene head-groups for instance, can contain hydrogen peroxide and organic peroxides, which can cause oxidation.

Detergents show different preferential extraction of lipids and proteins as well as solubilization potency. This has been demonstrated in Differential Detergent Fractionation (14).

It is often sufficient to use detergents only in the extraction step and it is not necessary to continue to use them in all the steps throughout a workflow. For membrane proteins where protein and detergents are complexed in mixed micelles, it is on the other hand important to maintain a certain concentration of the detergent throughout the workflow.

Spectral properties

Detergents with aromatic groups such as Triton X-100 will have substantial absorbance at 280 nm.

Compatibility with divalent cations

Long-chain carboxylic acids, for example, N-lauryl sarcosinate, as well as bile salts, have the property of precipitating with divalent cations. Bile salt such as cholate, derivatives such as CHAPS or CHAPSO do not precipitate with divalent cations.

pH dependence on solubility

Detergents containing carboxylic acids can be expected to protonate and become insoluble at weakly acidic pH values.

Temperature effects

Nonionic polyoxyethylene ethers, such as Triton X-100 and Lubrol™ PX, have a characteristic change of micellar weight with temperature. As temperature increases linearly, the micelle expands in an exponential fashion. This process leads to a separation of detergent as a nonaqueous phase at a discrete temperature known as the cloud point.

Chaotropes

A chaotropic agent is a substance that disrupts hydrogen bonds within or between biological molecules. At low concentrations, chaotropic agents cause selective solubilization. At higher concentrations they lead to protein inactivation. The most effective extracting chaotropes are in general the most effective protein denaturants. Urea and guanidine hydrochloride are commonly used chaotropes that increase protein solubility and minimize aggregation. 6 M guanidine hydrochloride or 8 M urea is generally needed to fully denature proteins. Ultrapure-grade compounds should be used.



To avoid modification of proteins, never heat a sample after adding urea. Elevated temperatures cause urea to hydrolyze to isocyanate, which modifies proteins by carbamylation. When the sample contains urea, it must not be heated above 37°C.



Urea forms complexes with nonionic detergents, which can affect chromatographic behavior. Many detergents are insoluble in moderate concentrations of guanidine hydrochloride. CHAPS and guanidine hydrochloride or urea have proved especially useful for the solubilization of aggregating proteins.

Extraction examples

Extracting protein from mammalian cultured cells

Because mammalian cells lack a cell wall, they can be readily lysed by a variety of methods, for example by use of mild detergents (see discussion above). When gentle conditions are required (i.e., to maintain structural integrity or biological activity), Nonidet P-40 or similar detergent should be used in a lysis buffer. An advantage of Nonidet P-40 is that lysis using it releases cytoplasmic and nuclear proteins without releasing chromosomal DNA, which because of its viscous nature, can cause numerous problems during protein preparation and analysis.

If maintaining structural integrity or biological activity is not a requirement, harsher conditions can be used (e.g., lysis buffer of radioimmunoprecipitation assay [RIPA]).

Use of Mammalian Protein Extraction Buffer

A variety of commercial products are available to assist in extracting protein from mammalian cultured cells. Among them is the Mammalian Protein Extraction Buffer from GE Healthcare.

Mammalian Protein Extraction Buffer is based on organic buffering agents, which utilize mild nonionic detergents, and a proprietary combination of various salts and agents to enhance extraction and stability of proteins. Depending on the application, additional agents such as chelating agents, reducing agents, and protease inhibitors may be added into the buffer (see Protease Inhibitor Mix as well as Nuclease Mix for reducing DNA (see Chapter 4)

Mammalian Protein Extraction Buffer reagent can be used for both cells in suspension and adherent cells. It is compatible with most applications, including enzyme assays, various chromatography protocols, electrophoresis, etc. The protein extract prepared with Mammalian Protein Extraction Buffer may be used for most enzyme assays including reporter gene assays (e.g., β -galactosidase, luciferase, chloramphenicol acetyltransferase), kinases (e.g., protein kinase C [PKC], protein kinase A [PKA] tyrosine kinase), and immunoassays (e.g., ELISA, Western blot, radioimmunoassay [RIA]). A summary of the protocol is provided below (see respective product instructions for details).

Materials

500 ml of Mammalian Protein Extraction Buffer is provided with the product
PBS
Refrigerating centrifuge

Advance preparation

1. Depending on the applications, DTT and EDTA may be added. Prepare an appropriate volume of the Mammalian Protein Extraction Buffer for use and add both DTT and EDTA to a final concentration of 5 mM. If the presence of a divalent metal ion is necessary for any application, do not add EDTA; instead, add an appropriate divalent salt to a final concentration of 5 mM.
2. If the inhibition of protease activity is required, add a cocktail of protease inhibitors to prevent protease activities during the extraction procedure (see Protease Inhibitor Mix, Chapter 4).

Protocol

1. Collect cells
For cell suspension: pellet the cells by centrifugation.
For adherent cells: scrape or detach cells then pellet or perform steps 2 to 4 on the culture plate.
2. Wash cell pellet
Wash the cell pellet with 5 to 10 ml of PBS. Residual cell culture medium is washed away.
3. Resuspend cell pellet
Add Mammalian Protein Extraction Buffer and resuspend the cell pellet.
4. Extract protein
Incubate on ice for 15 to 30 min. This is to allow solubilization to reach equilibrium.



A freeze/thaw step is not necessary for lysis. However, one or two freeze/thaw cycles are not detrimental to the cell extract, and often ensure complete lysis.

5. Recover extracted protein
Centrifuge at high g-force (e.g., $> 10\,000 \times g$) for 30 min in a refrigerated centrifuge. Collect the clear suspension for downstream processing and analysis. Solubilized proteins are recovered in the supernatant.



The cellular debris might contain some nuclear and membrane-bound proteins, which may be further extracted with a variety of detergents.

Mammalian Protein Extraction Buffer gives efficient protein extraction with high yield and reproducibility while retaining protein activity. In Figure 2.3, protein lysate, extracted from CHO cells using Mammalian Protein Extraction Buffer, demonstrated this. A comparison with lysates prepared using RIPA buffer was made, and the carbonic anhydrase activity was measured. The figure shows that high protein activity was retained using both methods while Mammalian Protein Extraction Buffer gave higher reproducibility.

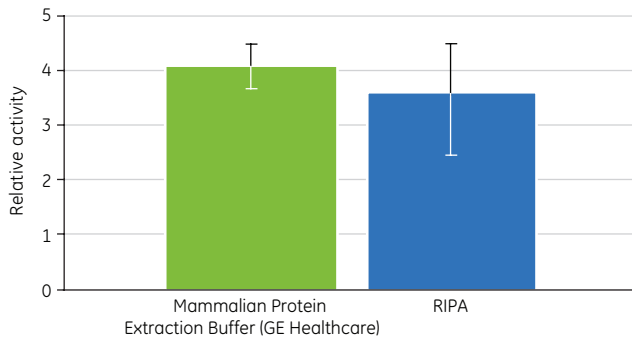

Fig 2.3. Carbonic anhydrase activity in CHO cell extracts prepared using Mammalian Protein Extraction Buffer (MPEB) or homemade RIPA buffer (50 mM Tris-HCl pH 7.5, 150 mM NaCl, 1% NP-40, and 0.1% Na-deoxycholate). The relative activity, corrected for differing sample concentrations, was calculated, and the average and standard deviation are shown.

Extracting protein from mammalian tissue

In some cases it is desirable to gently disrupt tissues and prepare enriched populations of intact cells, prior to cell disruption. A number of procedures have been well described in various cell biology manuals (e.g., see references 15, 16) for preparing cell suspensions from tissues and organs using mechanical or enzymatic methods. In general, enzymatic methods are preferred, because there is less damage to the integrity of the cells. In addition, it is usual to add EDTA to chelate Ca^{2+} ions, which are frequently involved in cell-cell adhesion. Preparation of cells obtained by these means is usually accomplished by:

- Differential centrifugation, which uses iso-osmotic density gradients of nontoxic/nonpermeable media such as Percoll™ or Ficoll™
- Centrifugal elutriation or counterstream centrifugation, which is based on two opposing forces: media flow and centrifugal force (17)
- Selective immunoseparation using monoclonal antibody (MAb)-bound magnetic beads (18)

Enzymatic lysis of yeast using Yeast Protein Extraction Buffer Kit

A method for lysing small quantities of yeast cells employing enzymatic lysis is described below. It uses the Yeast Protein Extraction Buffer Kit from GE Healthcare. The kit features a proprietary improvement on Longlife™ Zymolyase™ based spheroplast preparation and extraction of soluble proteins from yeast cells. The kit includes a protocol to make spheroplasts and remove the lytic enzyme Zymolyase, prior to lysis and extraction of yeast proteins. Yeast Protein Extraction Buffer is based on organic buffering agents, which utilize mild nonionic detergents, and a proprietary combination of various salts and agents to enhance extraction and stability of proteins. A ready-to-use Zymolyase preparation is also provided. Depending on the intended application; additional agents such as reducing agents, chelating agents, and protease inhibitors (see Chapter 4 for using Protease Inhibitor Mix) may be added into the Yeast Protein Extraction Buffer Kit. The proprietary composition of this reagent provides a simple and versatile method of yeast protein extraction. The Yeast Protein Extraction Buffer Kit eliminates

the need for laborious glass bead lysis of yeast cells. The kit is suitable for processing approximately 10 ml of yeast cell pellet, in either single or multiple smaller preparations. Yeast Protein Extraction Buffer Kit is compatible with any downstream application including enzyme assays, running various chromatography procedures, and gel electrophoresis applications.

Materials

Yeast Protein Extraction Buffer, Yeast Suspension Buffer, and Zymolyase are provided with the product.

β -mercaptoethanol

Advance preparation

Depending on applications, DTT and EDTA may be added. Prepare an appropriate volume of the Yeast Protein Extraction Buffer for use and add both DTT and EDTA to a final concentration of 5 mM. If the presence of a divalent metal ion is necessary for any application, do not add EDTA; instead add an appropriate divalent salt to a final concentration of 5 mM.

Protocol

If the inhibition of protease activity is required, add a cocktail of protease inhibitors to prevent protease activities during extraction procedure (see Protease Inhibitor Mix , Chapter 4).

1. Harvest yeast cells
Centrifuge to pellet yeast cells. Suspend the pellet in Yeast Suspension Buffer and add β -mercaptoethanol.
2. Suspend cells
Vortex and incubate the suspension for 5 min at 4°C. Vortex again to resuspend the cells to prepare a homogeneous solution.
3. Lyse cell wall
Add Longlife Zymolase. Incubate at 37°C for 30 to 60 min.
4. Isolate spheroplasts
Centrifuge the suspension at 10 000 \times g for 5 min. Remove and discard the supernatant carefully, leaving the spheroplast pellet in the tube. Debris from the digested cell wall will remain in the supernatant.
Optional: Add 5 to 10 volumes of Yeast Suspension Buffer to the spheroplast pellet. Resuspend the spheroplast by gently tapping the tube. Centrifuge again as above and discard the supernatant.
5. Lyse spheroplasts
Suspend the yeast spheroplast pellet in Yeast Protein Extraction Buffer. Mix and incubate on ice for 30 min. Incubating the cells for 1 to 3 min at 37°C or including a brief sonication step may further facilitate the lysis. Sonication is necessary for shearing genomic DNA.



Higher Yeast Protein Extraction Buffer to yeast pellet ratio improves cell lysis.

6. Collect extracted protein
Centrifuge at 20 000 \times g for 30 min at 4°C. Collect the lysate, which should be clear. The lysate is now ready for additional preparation steps or for analysis.

Mechanical cell disruption with glass beads is a common method for lysing yeast cells. Homemade RIPA buffer, together with glass beads, was used to lyse and extract protein from *S. cerevisiae* or *P. pastoris*. These samples, as well as the protein extracts prepared using the Yeast Protein Extraction Buffer Kit, were measured for retained protein activity using an alkaline phosphatase assay. This assay measures the conversion of the substrate para-Nitrophenylphosphate (pNPP) by alkaline phosphatase over time. The relative activity was corrected for sample concentration, and the averages are shown in Figure 2.4. For both yeast strains, the retained protein activity using the Yeast Protein Extraction Buffer Kit gave consistent results that were comparable to the conventional method using glass beads.

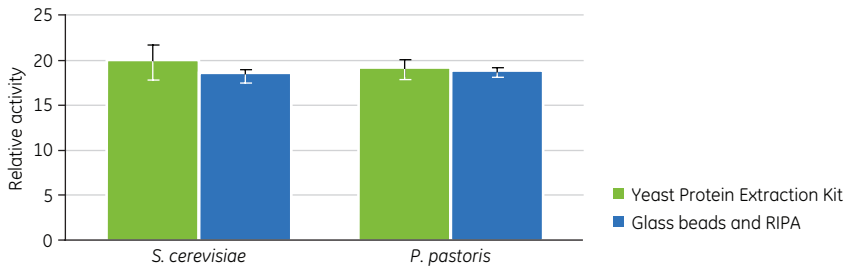

Fig 2.4. Alkaline phosphatase activity in yeast extracts prepared using either homemade RIPA buffer with glass beads or Yeast Protein Extraction Buffer. The relative activity, corrected for sample concentration, was calculated, and the average and standard deviations are shown.

Denaturing extraction of proteins from cells or tissue using 2-D Protein Extraction Buffer

Efficient cell lysis and protein extraction are the key steps for achieving high-quality results in downstream applications such as 2-D gel analysis. By combining appropriate chaotropes and detergents that denature and solubilize proteins from cells or tissue, an efficient and reproducible protein extraction is obtained. Six different extraction buffers are available from GE Healthcare, covering a wide range of different samples (Table 2.7). The optimal buffer will depend on the nature of your sample.

Table 2.7. Composition of 2-D Protein Extraction Buffer and 2-D Protein Extraction Buffer Trial Kit

2-D Protein Extraction Buffer	Composition
2-D Protein Extraction Buffer-I with DILUENT-I, 50 ml	Urea (< 10 M) and NP-40 (< 10%)
2-D Protein Extraction Buffer-II with DILUENT-II, 50 ml	Urea (< 10 M) and CHAPS (< 10%)
2-D Protein Extraction Buffer-III with DILUENT-III, 50 ml	Urea (< 8 M), Thiourea (< 5 M), CHAPS (< 5%), and Amidosulfobetaine-16 (ASB-16) (< 5%)
2-D Protein Extraction Buffer-IV with DILUENT-III, 50 ml	Urea (< 8 M), Thiourea (< 5 M), CHAPS (< 5%), and n-Decyl-N,N-dimethyl-3-ammonio-1-propanesulfonate (SB 3-10) (< 5%)
2-D Protein Extraction Buffer-V with DILUENT-II, 50 ml	Urea (< 8 M), Thiourea (< 5 M), and CHAPS (< 10%)
2-D Protein Extraction Buffer-VI with DILUENT-III, 50 ml	Urea (< 8 M), Thiourea (< 5 M), CHAPS (< 5%), and 3-(1-Pyridino)-1-propane sulfonate (NDSB-201) (< 4%)
2-D Protein Extraction Buffer Trial Kit, 6 × 10 ml	2-D Protein Extraction Buffer-I, -II, -III, -IV, -V and -VI, including DILUENT-I to -III

Because the buffers are provided in a dry powder formulation, problems associated with carbamylation are avoided. Necessary additives, such as enzyme inhibitors and/or reducing agents, may be added depending on the samples and application used. The buffers are compatible with 2-D electrophoresis but may also be used for other applications such as 1-D PAGE. 2-D Protein Extraction Buffers are compatible with CyDye™ differential gel electrophoresis (DIGE) fluors with the following exceptions:

- 2-D Protein Extraction Buffer-I is not optimal when CyDye DIGE Fluor minimal dye is used. The labeling efficiency will be slightly reduced.
- 2-D Protein Extraction Buffer-III and -IV are not recommended when CyDye DIGE Fluor Labeling Kit for Scarce Samples is used. Labeling efficiency is significantly reduced.

Extraction Buffer-I and -II are suitable for most applications. However, for stronger solubilization effects, Extraction Buffer-III, -IV, -V, or -VI may be used.

Figure 2.5 shows the 2-D electrophoresis workflow that was used to investigate differences in extraction capabilities of 2-D Protein Extraction Buffer-I to -VI.

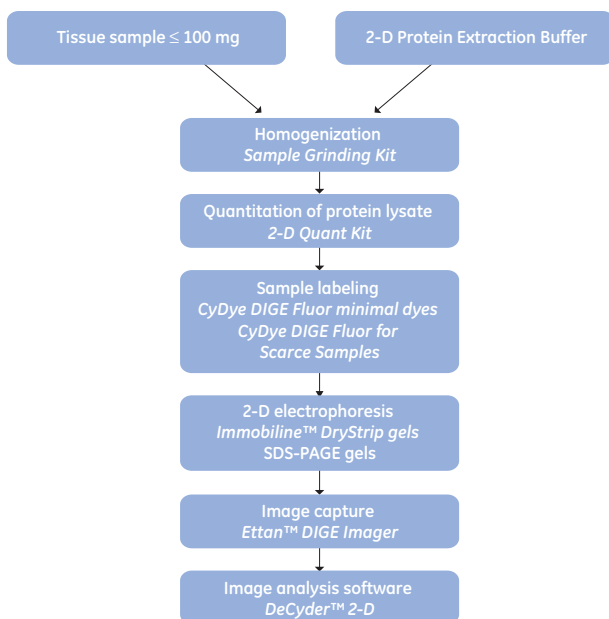

Fig 2.5. Workflow using 2-D DIGE to investigate differences in extraction capabilities of 2-D Protein Extraction Buffer-I to -VI.

In the following example (Fig 2.6), all six extraction buffers were compared with a reference buffer for their ability to extract rat liver protein. Most of the extraction buffers were compatible with CyDye DIGE Fluor minimal dye and gave a high labeling intensity compared to the reference, although Extraction Buffer (EB)-I gave a reduced labeling intensity and is therefore not recommended when using CyDye minimal dyes.

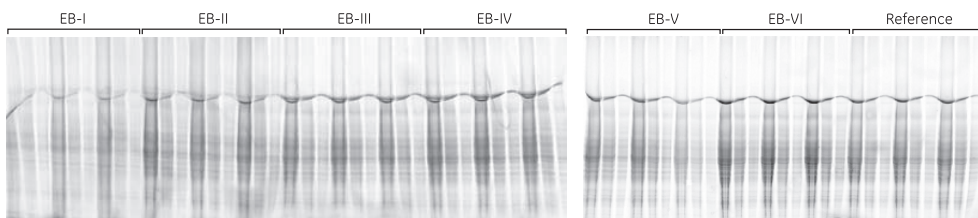

Fig 2.6. Rat liver samples were extracted using either the reference buffer or 2-D Protein Extraction Buffer-I to -VI. Protein extracts were subsequently labeled with a CyDye DIGE Fluor minimal dye and run on ExcelGel™ 8–18. In each set of three lanes, 20, 10, or 5 µl of sample was loaded.

Materials

2-D Protein Extraction Buffers I-VI (dry) and Diluents I-III are provided with the 2-D Protein Extraction Buffer Trial Kit

Enzyme inhibitors (e.g., Protease Inhibitor Mix)

Buffer additives

Reducing agents

Advance preparation

1. Reconstitute the supplied 2-D Protein Extraction Buffers -I to -VI by adding 5.75 ml or 5.0 ml of specific DILUENT. Add the specified DILUENT (according to the instructions) directly into the corresponding 2-D Protein Extraction Buffer bottle.
2. A smaller volume can also be prepared by using 1 g of dry powder mix with 1 ml or 1.15 ml of specific DILUENT (see the included instructions).
3. Add appropriate agents such as reducing agents, inhibitors, carrier ampholyte, bromophenol blue dye, etc.
4. Mix periodically by vortexing, and incubate at room temperature until the solution is clear.
5. Depending on applications, DTT and EDTA may be added. Prepare an appropriate volume of the 2-D Protein Extraction Buffer for use and add both DTT and EDTA to a final concentration of 5 mM.

Protocol

If the inhibition of protease activity is required, add a cocktail of protease inhibitors to prevent protease activities during extraction (see Protease Inhibitor Mix, Chapter 4).

1. Collect tissue sample
2. Homogenize tissue
Add up to 2 to 3 volumes of 2-D Extraction Buffer to the tissue. Disrupt the tissue structure by using a suitable homogenization technique, for example, grinding with Sample Grinding Kit. This will result in simultaneous disruption of the tissue, solubilization of the proteins, and inactivation of detrimental enzymatic activity.
3. Add additional 2-D Extraction Buffer to about 5 to 10 volumes per initial sample size. Mix thoroughly.
4. Clarify the extract
Centrifuge the suspension at $15\,000 \times g$ for 20 min. Remove the supernatant carefully, leaving the pellet in the tube.
5. Determine protein concentration
Quantitate the protein content by using a method that is compatible with chaotropes, detergents, and possibly reducing agents, for example, 2-D Quant Kit from GE Healthcare.
6. Run 2-D electrophoresis (see *2-D Electrophoresis using immobilized pH gradients: Principles and Methods* or Ettan DIGE System User Manual) or move on to the next step in the workflow if running a different application.

Protein precipitation as an alternative to protein extraction

Sometimes it is advantageous to make the proteins insoluble by precipitation during cell disruption or tissue homogenization, for example, by grinding flash-frozen samples in the presence of trichloroacetic acid (TCA). The major nonprotein contaminants (e.g., nucleic acids, lipids, carbohydrates, etc.) are kept soluble for easy removal. The protein precipitates can be recovered by filtration or centrifugation, and the proteins may be redissolved in a suitable buffer. Precipitation is discussed further in Chapter 3 for removal of contaminants in samples.

Clarification of protein extract

Particulates may be removed from protein extracts using centrifugation or filtration. Particulate removal is necessary if the sample will be subjected to column chromatography. A filter with a 0.45 µm pore size is sufficient for clarification. GE Healthcare provides an extensive line of filters for use with or without a syringe, for example, Whatman™ UNIFILTER™ microplates.

Protein quantitation

After homogenization and extraction of proteins, a small sample of the extract should be collected and analyzed. A large number of different protein quantitation methods exist that all have advantages and disadvantages to be considered. There are suitable analyses to quantitate proteins, depending on the particular application, for example, SDS-PAGE, Western blotting, enzymatic assays, or binding assays. Some of the different methods based on the absorbance measurement are shown in Table 2.8; Appendix 2 provides details of protein determination by absorbance methods.

Table 2.8. Methods for determination of protein concentration

Assay	Description	Advantages	Disadvantages
Near UV absorbance	Quantitate proteins by measuring UV absorbance at 280 nm.	Simple, sample is not destroyed	Interference from nonprotein chromophores
Bradford (19)	Coomassie™ Brilliant Blue G-250 dye binds selectively to arginine and aromatic residues. Measured by absorbance at 595 nm.	Fast, sensitive	Nonlinear, incompatible with detergents
Bicinchoninic acid (BCA)	Reduction of Cu ²⁺ to Cu ¹⁺ by amide bonds (Biuret reaction). Cu ¹⁺ forms complex with BCA that is detectable at 562 nm.	Sensitive	Slow, incompatible with Cu-chelators, reducing agents
2-D Quant Kit	Precipitation of proteins followed by binding of Cu-ions. Absorbance measured at 480 nm.	Compatible with detergents, reductants, chaotropes, and carrier ampholytes	Slow

Determination of protein concentration in harsh solutions using 2-D Quant Kit

2-D Quant Kit from GE Healthcare is designed for the accurate determination of protein concentration in samples to be analyzed by high-resolution electrophoresis techniques such as 2-D electrophoresis, SDS-PAGE, or IEF. Many of the reagents used in the preparation of such samples, including detergents, reductants, chaotropes, and carrier ampholytes, are incompatible with other protein assays. The 2-D Quant Kit procedure is based on quantitatively precipitating proteins while leaving interfering substances in solution. The assay is based on the specific binding of copper ions to protein. Precipitated proteins are resuspended in a copper-containing solution, and unbound copper is measured with a colorimetric agent. The color intensity is inversely related to the protein concentration.

The assay has a linear response to protein in the range of 0 to 50 µg.

The procedure is compatible with common sample preparation reagents such as 2% SDS, 1% DTT, 8 M urea, 2 M thiourea, 4% CHAPS, 2% Pharmalyte™, and 2% IPG Buffer.

Current spectrophotometric methods of quantitating protein rely on either Coomassie dye binding (Bradford, reference 19) or protein-catalyzed reduction of cupric (Cu²⁺) ion to cuprous (Cu⁺) ion (20–22). Dye-binding assays cannot be used in the presence of any reagent that also binds Coomassie dye. This includes carrier ampholytes such as Pharmalyte and IPG Buffer and detergents such as CHAPS, SDS, and Triton X-100. Assays that depend on the reduction of cupric ion cannot be used in the presence of reductants such as DTT, or in the presence of reagents that form complexes with cupric ion, such as thiourea or EDTA.

Materials

Precipitant, Coprecipitant, Copper solution, Color reagent A, Color reagent B, and BSA standard solution are provided with the product.

2 ml microcentrifuge tubes

Vortex mixer

Microcentrifuge

Visible light spectrophotometer

Advance preparation

1. Prepare an appropriate volume of working color reagent by mixing 100 parts of color reagent A with 1 part color reagent B. Each individual assay requires 1 ml of working color reagent.
2. Working color reagent can be stored at 4°C to 8°C for up to one week or as long as the optical absorbance (A_{480}) of the solution remains below 0.025 at 480 nm.

Protocol

See the product instructions for the complete protocol.

1. Prepare the solution for a standard curve.
2. Add the BSA standard solution (2 mg/ml) to six tubes to final amount 0 µg (blank), 10, 20, 30, 40, and 50 µg.
3. Prepare samples.
Add 1 to 50 µl of the sample to be assayed in separate tubes.
4. Proceed according to the instructions to generate samples for spectrophotometric measurement.
5. Read the absorbance of each sample and standard at 480 nm using water as the reference. The absorbance should be read within 40 min of the addition of working color reagent.
6. Plot a standard curve based on the absorbance of the standards against the quantity of protein. Use this standard curve to determine the protein concentration of the samples.

Note: Unlike most protein assays, the absorbance of the assay solution decreases with increasing protein concentration. Do not subtract the blank reading from the sample reading or use the assay blank as the reference.

2-D Quant Kit can be used to accurately quantitate protein in the presence of the substances shown in Table 2.9. A typical standard curve is shown in Figure 2.6.

Table 2.9. The upper concentration limits of some compounds tested for compatibility with 2-D Quant Kit

Compound	Concentration
SDS	2% (w/v)
CHAPS	4% (w/v)
Triton X-100	1% (w/v)
Pharmalyte pH 3-10	2% (v/v)
IPG Buffer pH 3-10 NL	2% (v/v)
Tris	50 mM
EDTA	10 mM
DTT	1% (65 mM)
β -Mercaptoethanol	2% (v/v)
Urea	8 M
Thiourea	2 M
Glycerol	30% (w/v)

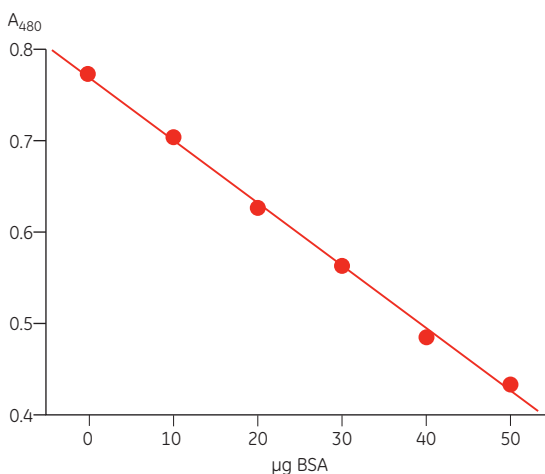

Fig 2.7. Typical standard curve plot generated by using 2-D Quant Kit.

References

1. Aniento, F. and Gruenberg, J. Subcellular fractionation of tissue culture cells, in *Current Protocols in Protein Science* (Coligan, J. *et al.* eds) John Wiley and Sons, Inc., New York, 4.3.1–4.3.21 (2003).
2. Marcus, F. Preferential cleavage at aspartyl-prolyl peptide bonds in dilute acid. *Int. J. Pept. Protein Res.* **25**, 542–546 (1985).
3. Barrett, A. J. and Salvesen, G. S. eds. *Proteinase Inhibitors*, Elsevier Science Publishers, Amsterdam (1986).
4. Beynon, R. J. and Bond, J. S. *Proteolytic Enzymes. A Practical Approach*, IRL Press, Oxford (1989).
5. Barrett, A. J. *et al.* eds. *Handbook of Proteolytic Enzymes*, Academic Press, London (1998).
6. Janson, J.-C. and Rydén, L. *Protein Purification, Principles, High Resolution Methods and Applications*, Wiley-VCH, Germany (1998).
7. Scopes, R. K. *Protein Purification, Principles and Practice*, Springer Publishing Company, New York (1994).

8. McNally E. J. and Hastedt, J. E. eds. *Protein Formulation and Delivery (Drugs and the Pharmaceutical Sciences)*, Informa Healthcare, Zug (2007).
9. Sun, G. and Anderson, V. E. Prevention of artifactual protein oxidation generated during sodium dodecyl sulfate-gel electrophoresis. *Electrophoresis* **25**, 959–965 (2004).
10. Lenk, T.J. *et al.* IR spectral changes of bovine serum albumin upon surface adsorption. *J. Biomed. Mater Res.* **23**, 549–569 (1989).
11. Righetti, P. G. and Gianazza, E., New developments in isoelectric focusing. *J. Chromatogr.* **193**, 1–8 (1980).
12. Weiller, G. F. *et al.* The modal distribution of protein isoelectric points reflects amino acid properties rather than sequence evolution. *Proteomics* **4**, 943–949 (2004).
13. Pitt-Rivers, R. and Ambesi Impiombato, F. S. The binding of sodium dodecyl sulphate to various proteins. *Biochem. J.* **109**, 825–830 (1968).
14. Ramsby, M. L. *et al.* Differential detergent fractionation of isolated hepatocytes: biochemical, immunochemical and two-dimensional gel electrophoresis characterization of cytoskeletal and noncytoskeletal compartments. *Electrophoresis* **15**, 265–277 (1994).
15. Celis, J. E. ed., *Cell Biology: A Laboratory Handbook Vol. 1*, Academic Press, London UK (1998).
16. Spector, D. L. *et al.* eds. *Cells: A Laboratory Manual*, Cold Spring Harbor Laboratory Press, New York (1998).
17. Bird, R. C. Cell separation by centrifugal elutriation, in *Cell Biology: A Laboratory Handbook*, (Celis, J. E. ed.) Academic Press, California, pp. 205–208 (1998).
18. Neurauter, A. A. *et al.* Immunomagnetic separation of animal cells, in *Cell Biology: A Laboratory Handbook* (Celis, J. E. ed.) Academic Press, California, pp. 197–204 (1998).
19. Bradford, M. M. Rapid and sensitive method for the quantitation of microgram quantities of protein utilizing the principle of protein-dye binding. *Anal. Biochem.* **72**, 248–254 (1976).
20. Goshev, I. and Nedkov, P. Extending the range of application of the biuret reaction: quantitative determination of insoluble proteins. *Anal. Biochem.* **95**, 340–343 (1979).
21. Lowry, O. H. *et al.* Protein measurement with the Folin phenol reagent. *J. Biol. Chem.* **193**, 265–275 (1951).
22. Smith, P. K. *et al.* Measurement of protein using bicinchoninic acid. *Anal. Biochem.* **150**, 76–85 (1985).

Chapter 3

Increasing detectability of targeted proteins

Introduction

In Chapter 2, the process of collecting sample from the original source, followed by extracting and stabilizing its proteins, was discussed. The optimal output from this process is a protein population in the solution that retains the *in vivo* state of the biological source as much as possible. Before final preparation of the sample for a specific analytical method, an additional step aimed at increasing detectability of targeted proteins is often necessary (Fig 3.1). The rationale for this step is to improve the likelihood of successful analysis of all protein species of interest by modulating the protein content to match the capabilities of the analytical step.

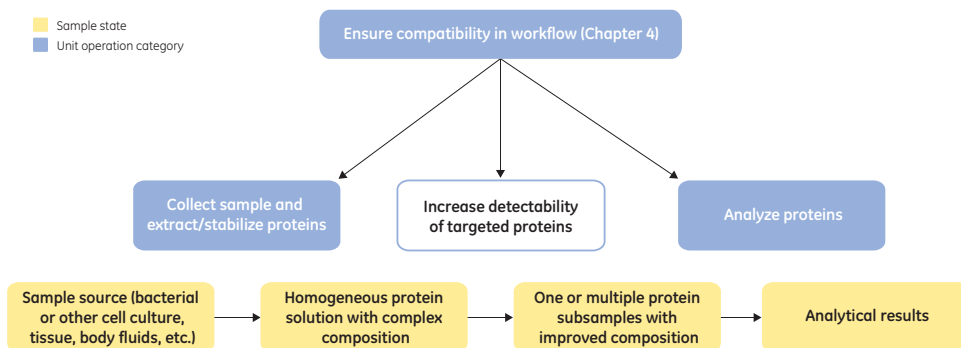

Fig 3.1. High-level workflow of protein sample preparation and analysis. The unit operation category discussed in this chapter is framed.

For recombinant or hybridoma cell cultures, this modulation is generally identical to generating one final sample containing a purified single protein for detailed analytical interrogation (i.e., structure determination or antibody screening and characterization). Tagged recombinant proteins and monoclonal antibodies can be purified by using efficient affinity media, often followed by polishing. Detailed discussions of these subjects are outside the scope of this handbook and can be found in additional handbooks from GE Healthcare, including *Recombinant Protein Purification Handbook: Principles and Methods*; *Antibody Purification: Principles and Methods*; and *Purifying Challenging Proteins*. The preparation of small-scale samples for screening purposes is briefly described in this chapter. Screening in microwell plates and the use of robotic systems is discussed in Chapter 5.

For analytical procedures aimed at broad analysis of proteins present in biological model systems (i.e., proteomics in general, systems biology, or biomarker development), increasing the detectability means applying methods to generate one or multiple sample fractions with reduced protein complexity and dynamic range. Starting out with large initial sample amount, this approach will also enable increased loading of low-abundance proteins, thereby increasing the overall detecting sensitivity. This process is needed because the sensitivity, resolving power, dynamic range, and data acquisition speed of current global protein analysis methods (2-D electrophoresis and LC-MS/MS) cannot fully match the complexity and dynamic range found in most biological systems (see discussion in Chapter 1). The properties of the sample itself, limitations in each step of the sample manipulation, and the performance of the final analysis will all affect the results. It is difficult to advise on the optimal composition of fractions going to analysis because several parameters influence the final success rate (1).

Strategies for increasing protein detection including target protein enrichment or depletion of high-abundance, interfering proteins are discussed in this chapter as follows:

- Protein fractionation
 - using differential precipitation or chromatography
- Affinity-based depletion of high-abundance proteins
 - removal of albumin and IgG from plasma or serum
- Affinity-based enrichment of proteins and protein subgroups; immunoglobulins, biotinylated proteins, phosphorylated proteins, and peptides
 - using a covalently coupled ligand
 - using immunoprecipitation of target protein

Before entering into a discussion of protein fractionation, it is worth pointing out that a more “global” method of fractionation in the same, undivided sample into DNA, RNA, and protein is possible.

Until recently, researchers in several fields such as functional genomics, molecular genetics, and biomarker studies used three separate kits to isolate DNA, RNA, and proteins from a divided sample for using in downstream applications. However, the use of divided samples could potentially distort the results due to heterogeneity between different cell and tissue samples. The demand for good correlation between transcript (gene) expression, protein expression, copy number variation, and single nucleotide polymorphism (SNP) has resulted in the development of methods for isolating multiple analytes from the same sample. When DNA, RNA, and protein are prepared from the same sample, it is possible to correlate DNA/RNA/protein data directly. This ensures that results are not an artifact of the experimental design, but are a characteristic of the sample.

GE Healthcare provides a method for preparing genomic DNA, total RNA, and denatured protein from an undivided sample, using *illustra™ triplePrep Kit*, which isolates these three categories of molecules sequentially. The chaotropic lysis buffer immediately inactivates DNase, RNases, and proteases, which are present in virtually all biological materials, and creates appropriate binding conditions that favor adsorption of DNA to the silica membrane in a minicolumn. RNA and protein pass through the column. The conditions of the flowthrough are adjusted to favor total RNA adsorption to a second silica column. Protein passes through the column, and total denatured protein is precipitated. See *illustra triplePrep Kit* instructions for more detail.

Protein fractionation

Protein fractionation is defined in this handbook as encompassing procedures used to divide an initial solubilized protein population into multiple subsamples/fractions based on differences in nonspecific (chemical/physical) properties of the proteins present (i.e., size, charge distribution, pI, hydrophobicity, or solubility). Procedures can be tailored to handle both denaturing and nondenaturing conditions. Often, several unit operations with complementing selectivity are combined in series. Protein fractionation can be used in two principal ways:

1. For hypothesis-driven and focused analysis of an initial protein population: Only one or a few fractions are analyzed, for example, after removing high-molecular-weight proteins from plasma. As a strategy, this approach is based on the fact that most of the high-abundance proteins in plasma have a high molecular weight ($M_r > 60\,000$) and the hypothesis that most potential biomarkers are of low molecular weight.
2. For global analysis of an initial protein population: Each protein is of potential interest and, in general, multiple fractions are generated and analyzed.

Technology options for protein fractionation include (2-7):

- Differential precipitation (e.g., using 2-D Fractionation Kit from GE Healthcare)
- Chromatography techniques (i.e., IEX, GF, chromatofocusing, RPC, and HIC)
- Filters that provide cutoff based on molecular weight (e.g., UF)
- 1-D PAGE
- Free-flow IEF
- Differential detergent fractionation (based on protein solubility)

Differential precipitation of proteins using 2-D Fractionation Kit

Protein precipitation in general will be discussed in Chapter 4. Here we address the use of protein precipitation as a fractionation technique. 2-D Fractionation Kit from GE Healthcare exploits the property of protein molecules to precipitate in response to changes in solvent composition (e.g., ionic strength, pH, temperature). The solvent composition is changed in a stepwise fashion such that a series of protein fractions is produced based on differential solubility. Fractionated proteins are suitable for use in 2-D electrophoresis or MS.

An example of protein fractionation using the 2-D Fractionation Kit is shown in Figure 3.2. This method first fractionates the sample into soluble and insoluble fractions. The soluble fraction is fractionated further. The kit has been optimized based on a protocol that produces a set of seven fractions. A summary of the protocol is provided below. Please note that there are options to optimize the protocol to your own needs. See product instructions for details.

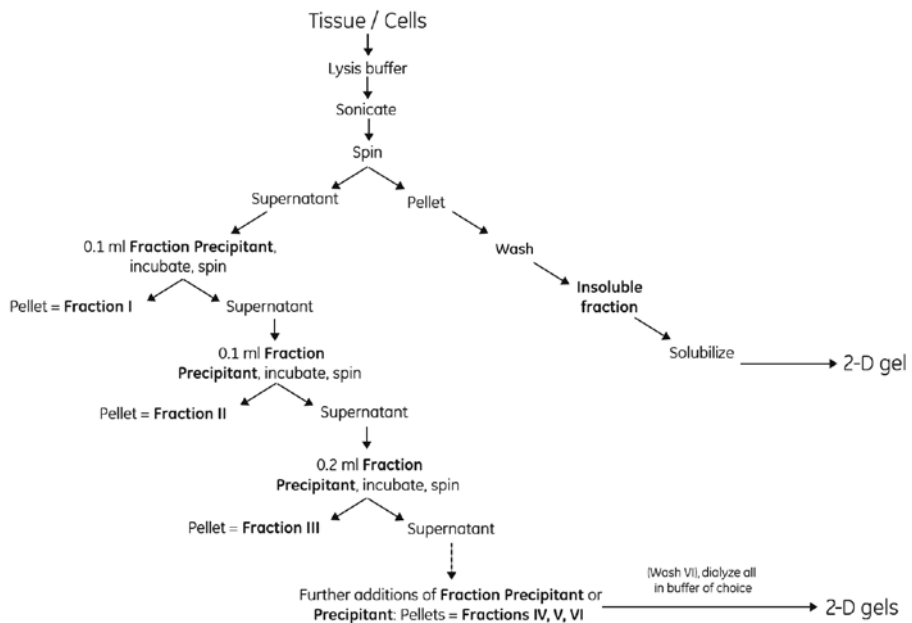

Fig 3.2. Schematic representation of protein fractionation using 2-D Fractionation Kit.

Materials

The following solutions are provided in the kit:

Lysis Buffer, Fraction Precipitant, Precipitant, Coprecipitant, Wash Buffer, Solubilizer, and Diluent.

Advance preparation

1. Transfer Wash Buffer to -20°C for 1 to 2 h before use.
2. Chill Lysis Buffer in a wet ice bath.
3. Warm the bottle of Fraction Precipitant if crystals are visible.
4. Prepare the Solubilizer solution by adding the dry powder to an aliquot of Diluent. Prepare only as much as it is needed for each experiment.

Protocol

1. Sonicate the cells or tissue in Lysis Buffer at 0°C to 4°C to lyse the cells.
2. Pellet insoluble proteins by centrifugation at 20 000 × g for 30 min at 4°C.
3. Transfer the supernatant to a new tube.
4. Repeat steps 1 and 2 on the remaining pellet. Pool the supernatants with the supernatant from step 3. Label the tube “Soluble Protein Component.”
5. Wash the pellet. Label the tube with the pellet “Insoluble Protein Fraction.”
6. Process the Soluble Protein Component using protein precipitation with 2-D Fractionation Kit. Six fractions will be produced. See kit instructions for details.
7. Process the Insoluble Protein Fraction in Solubilizer according to the kit instructions.

Fractionation based on chromatography

Fractionation of proteins in small scale using IEX, GF, or RPC can be performed manually with a syringe (stepwise change of buffers used) or with a chromatography system such as ÄKTAmicro from GE Healthcare, which is suited for small sample volumes and gives improved control and reproducibility by delivering accurate flow rates and gradients. A large number of different prepacked columns are available in appropriate scales that can be used with the chromatography system (see Appendix 3). The different chromatographic techniques are covered in other handbooks from GE Healthcare. An example of fractionation of proteins extracted from a cell culture is shown in Figure 3.3. In this example, the fractions obtained after IEX were digested by trypsin followed by identification of the proteins using nano-LC-MS/MS (data not shown).

Column: Mono Q™ PC 1.6/5
Sample: Total protein extract from immortalized lymphatic endothelial cells left untreated (controls) or treated with growth factors vascular endothelial growth factor A (VEGF-A) or vascular endothelial growth factor C (VEGF-C)
Buffer A: 20 mM Tris-HCl, 8 M urea, 6% isopropanol, pH 8.0
Buffer B: Buffer A + 1 M NaCl
Flow rate: 0.2 ml/min
Gradient: Linear salt gradient, 0% to 50% buffer B
Detection: UV 215 nm and UV 280 nm
System: ÄKTAmicro

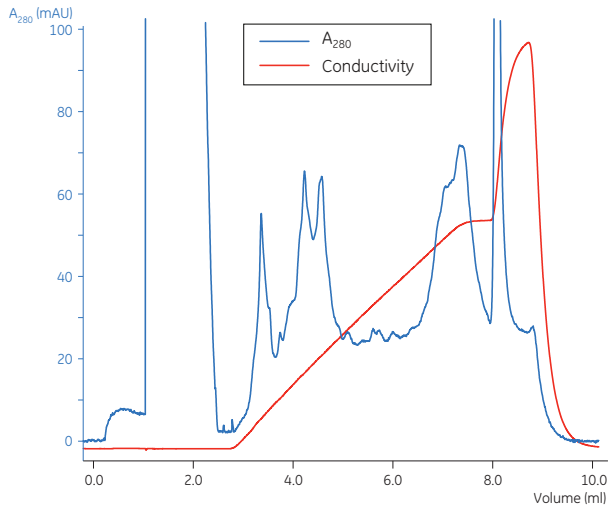

Fig 3.3. Chromatogram resulting from strong anion exchange chromatography (AIEC) of total protein extracts prepared from VEGF-A treated cells using Mono Q PC 1.6/5 on ÄKTAmicro system. Fractions of 0.4 ml were collected throughout the separations. Data for prefractionation of control and VEGF-C treated cells are not shown.

Affinity-based protein depletion of high-abundance proteins

Affinity-based protein depletion, also called negative chromatography, can be seen as a more targeted form of protein fractionation, where a fraction void of a selected number of proteins is generated. In this technique, one or several sorts of affinity binders (ligands) are immobilized on a solid support (i.e., chromatographic medium) for specific binding of unwanted proteins from a complex protein solution. Often, only the flowthrough fraction goes on for analysis. By depleting abundant proteins from the samples, the analysis of less abundant proteins will be facilitated. The depletion also permits a higher sample load increasing the amount of other proteins remaining in the analysis. The technique is generally limited to nondenaturing conditions because specific interactions require retained 3-D structure of both ligands and the targeted proteins. Unwanted proteins can include any protein present in a particular source that is not relevant to the analytical purpose and interferes with the analysis in some way, for example, protein isoforms that mask an interesting region of a 2-D gel map. Another example is ribulose biphosphate carboxylase/oxygenase (RuBisCO), which is a highly abundant protein in plants (~ 40% of total protein) and is found in green leaves.

By far the most common application is the removal/depletion of high-abundance proteins from animal or human plasma/serum. The importance of plasma/serum for biomarker discovery, its compatibility with nondenaturing conditions, and the fact that it contains a relatively small number of proteins makes depletion extremely useful (Fig 3.4). Albumin and the total IgG population make up ~ 70% of the total protein content in human plasma.

The 10 most abundant proteins represent ~ 90%, and the 22 most abundant proteins comprise ~ 99% of the total protein concentration (8-9). Depleting some of these proteins in a single step can be performed by using antibodies or affinity binders based on the other (Fig 3.4) protein scaffolds (10-16). For optimal performance, different approaches need to be tailored for different species because small differences of protein homologs are present in different species.

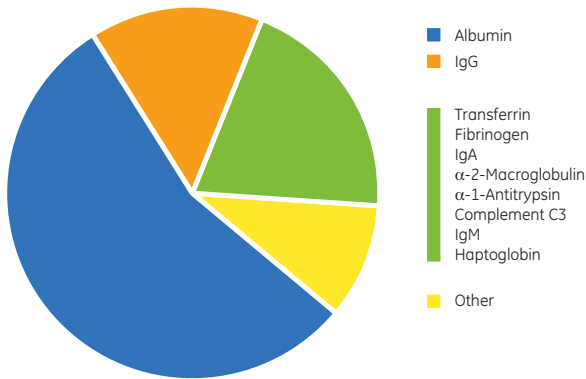

Fig 3.4. Relative abundance of different proteins in human plasma.

Other biofluids such as urine and CSF are also suited for depletion methods. The protein content of these biofluids is high and similar to the content of as plasma, but the exact composition differs. The protein concentration in urine is also much lower than in plasma/serum, and the concentration to be increased prior to the depletion step. Therefore, the depletion protocol and/or the product need to be tailored for good overall depletion efficiency.

Depletion of human albumin and IgG

The most efficient method to remove high-abundance proteins is by using affinity ligands such as antibodies, although other techniques are available, for example, dye-based Blue Sepharose, for the removal of albumin.

GE Healthcare provides both HiTrap™ Albumin & IgG Depletion and Albumin & IgG Depletion SpinTrap™ columns for the depletion of albumin and IgG from human serum and plasma. HiTrap products can be used with a syringe, peristaltic pump, or chromatography system such as ÄKTAmicro. SpinTrap columns are designed for use in a microcentrifuge. Samples other than human plasma and serum that also contain albumin and IgG can be used but modification of the protocol might be required.

The recommended sample volumes are ~ 50 µl for the SpinTrap columns or ~ 150 µl for the HiTrap columns to remove > 95% of the albumin content and > 90% of the IgG content in samples containing normal levels of these proteins. It is recommended to apply lower volumes when samples contain higher albumin or IgG levels, for example, 100 to 125 µl to HiTrap columns or 25 µl to SpinTrap columns to obtain the same depletion efficiency.



The depletion technique is especially valuable for global analysis, where the less abundant proteins might be obscured by the presence of albumin and/or IgG, for example, in 2-D electrophoresis.

An example showing the effect of albumin and IgG depletion prior to 2-D electrophoresis is shown in Figure 3.5.

Protein depletion using HiTrap Albumin & IgG Depletion columns

A protocol summary is provided below. See the product instructions for more details.

Materials

HiTrap Albumin & IgG Depletion columns, 2 × 1 ml (a connector kit is provided with the product).



Water and chemicals used for buffer preparation should be of high purity. Filter buffers through a 0.22 µm or a 0.45 µm filter before use to remove any potential debris.

HiTrap Albumin & IgG Depletion columns can be operated with a syringe, peristaltic pump, or LC systems such as ÄKTA systems.

Advance preparation

Binding buffer: 20 mM sodium phosphate, 0.15 M NaCl, pH 7.4.

Elution buffer: 0.1 M glycine-HCl, pH 2.7.

No dilution of the human plasma is required. Filter the human plasma through a 0.45 or 0.22 µm filter shortly before applying it to the column.

Protocol

A flow rate of 1 ml/min is recommended for the entire depletion procedure.

1. Fill the pump tubing with binding buffer. Remove the stopper and the snap-off end from the column and connect it to the pump tubing “drop to drop” to avoid introducing air into the column.
2. Wash the column with 5 ml of binding buffer to remove the 20% ethanol storage solution.
3. Equilibrate with 10 ml of binding buffer.
4. Apply 150 µl of filtered human plasma and wash with at least 5 ml of binding buffer until the absorbance reaches a steady baseline. Collect the flowthrough from sample application and wash step. The flowthrough contains the depleted sample.
5. Optional: Elute and collect the bound proteins (albumin and IgG) with 10 ml of elution buffer.



Step 5 should be performed if the column is to be reused or if the bound albumin and IgG fraction is to be analyzed.

For a manual depletion procedure (without using a pump), the syringe is connected to the column by the provided Luer connector. Be careful to use a flow rate of approximately 1 ml/min.



Too high a flow rate will damage the packing of the chromatography medium in the column and cause high backpressure.



Some proteins copurify with albumin and/or IgG either by association through protein interactions or by nonspecific binding to the column. The bound fraction may therefore also be considered for analysis.



To prevent carryover between samples and to maintain binding capacity, it is important to clean the column in place after elution of the bound proteins; this is performed with 70% ethanol in water.

To evaluate the effect on analytical resolution, nondepleted and depleted plasma were analyzed by 2-D gel electrophoresis (Fig 3.5). Parallel runs in the gel and labeling of the samples with different fluorescent dyes made it possible to estimate the differences in protein abundances. A comparison of protein spot maps for nondepleted plasma and albumin/IgG-depleted plasma show enhanced visualization of proteins with pI and/or M_r similar to albumin and IgG (marked with circles). In addition, an increased number of less abundant proteins were detected (green spots).

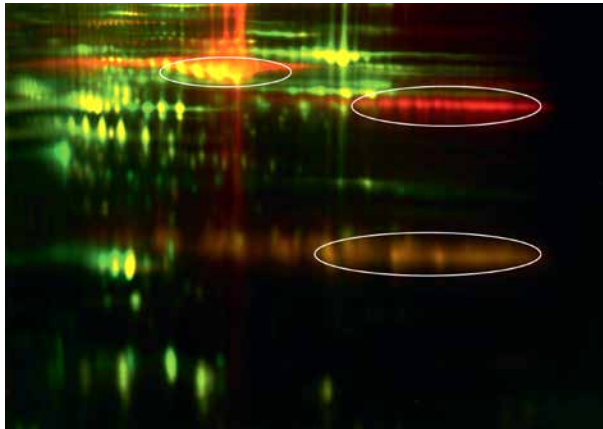

Fig 3.5. Two-dimensional spot maps of depleted plasma (green spots) and nondepleted plasma (red spots). The yellow spots are proteins detected in both samples.

Affinity-based protein sample preparation and analysis of monoclonal antibodies in serum

Another strategy for analyzing the levels of a therapeutic MAb in serum samples is using Surface Plasmon Resonance (SPR). SPR is an optical technique utilized for detecting molecular interactions. Binding of a mobile molecule (analyte) to a molecule immobilized on a thin metal film changes the refractive index of the film.

The following application shows a two-step sample preparation workflow combining affinity capture and buffer exchange developed to reduce the “interference” caused by component in the serum. Possible contaminants in the serum matrix are endogenous proteins, lipids, salt and other small molecules.

Undiluted serum is a highly viscous liquid mainly due to its high protein content (40 to 70 mg/ml). A two-step sample preparation workflow combining affinity capture and buffer exchange was developed and is shown in Fig 3.6.

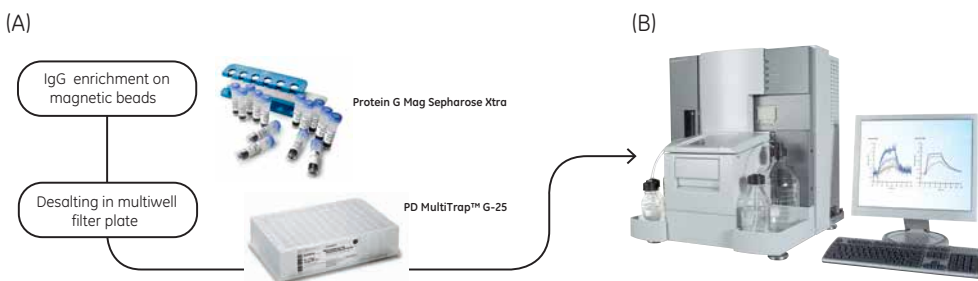

Fig 3.6. (A) Sample prep strategy to capture MAb from serum samples. Step 1: Affinity capture of target MAb, followed by mild elution. Step 2: Buffer exchange of eluted MAb into analysis running buffer. (B) Final analysis of MAb on a Biacore™ T200 instrument using a series S sensor chip CM5 with immobilized anti-MAb.

First, Rituximab was spiked into serum samples from four individuals followed by direct SPR analysis. Then, the two-step sample preparation workflow was tested with Rituximab spiked into the same serum samples. Comparison with directly analyzed (spiked) serum samples was made.

Background signal was significantly lower from serum samples after running the two-step sample prep protocol. The conclusion of this work was that SPR using Biacore T200 can be used for development of a serum sample preparation method for MAb analysis. Furthermore, the background (matrix) signal was heavily reduced in the SPR analysis.

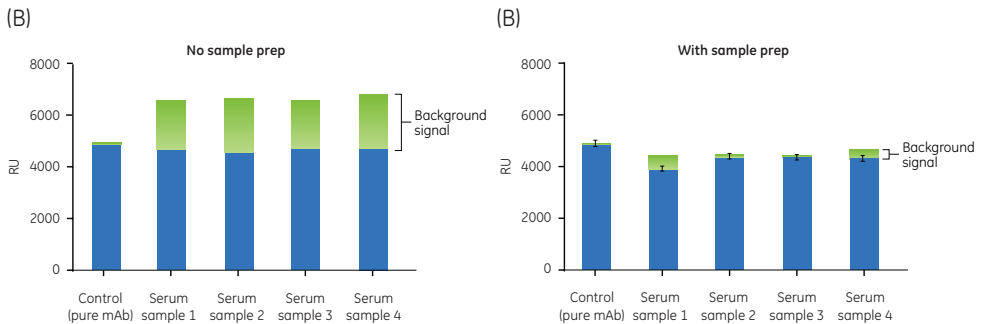

Fig 3.7. (A) Binding levels of Rituximab in blue and background signals in green for serum samples directly analyzed using Biacore T200. (B) Binding levels of Rituximab in blue, (mean \pm SD) and background signals in green for serum samples analyzed by Biacore T200 after sample preparation.

Custom depletion options

Several ways exist to customize a depletion or enrichment procedure by using one of the tools available for immunoaffinity and pull-down experiments.

Affinity-based enrichment of proteins and protein subgroups

Affinity-based enrichment techniques can also be seen as a more targeted form of protein fractionation, in which a single fraction enriched in a selected group of proteins is generated (10, 11, 17). The techniques are often limited to investigational strategies focusing on particular subgroups of proteins (based on assumed knowledge or hypothesis). Affinity binders (ligands) with specific affinity for a particular group of proteins are immobilized to a solid support (i.e., chromatographic medium or magnetic beads) and used to bind the targeted group while allowing all other proteins to elute in the flowthrough and/or wash fractions. The bound fraction is then eluted, yielding a highly enriched protein population for further analysis. Solutions/formats that allow processing of large initial volumes, followed by elution in small volumes, are particularly valuable for enrichment of low-abundance proteins. In most cases affinity-based enrichment is not compatible with denaturing conditions, because specific binding is dependent on protein 3-D structure.

Proteins that can be enriched include:

- γ Immunoglobulins—Ligands are Protein A or Protein G.
- Biotinylated proteins—Streptavidin is used for specific binding.
- Phosphorylated proteins and peptides—Ligand options include phospho-epitope or specific antibodies (see Chapter 1 for an example), metal chelates, or metal oxides.
- Glycosylated proteins—Various lectins are generally used as ligands.
- Kinases—ATP analogs can be used as ligands.
- DNA-binding proteins—Ligands include heparin, nonspecific and sequence-specific DNA probes.
- Protein complexes—Antibodies directed against a component in a protein complex are used as ligands for native sample sources. Affinity-tag ligands are used for genetically engineered systems, where an affinity ligand (bait) is expressed in a tagged format. The handbook *Purifying Challenging Proteins* (article code number 28-9095-31) from GE Healthcare includes details on enrichment of complexes via tagged approaches.

- Protein isomers—Antibodies directed against conserved regions can be used as ligands.
- Tagged recombinant proteins—Purification of tagged proteins is typically based on specific interactions between the tags and ligands. Four commonly used tags are polyhistidines (histidine), glutathione S-transferase (GST), *Strep-tag*[™] II, and Maltose Binding Protein (MBP). GE Healthcare offers a series of different products in different formats for purification of these tagged proteins.

More detailed information for these products can be found in the *Recombinant Protein Purification Handbook: Principles and Methods* (article code number 18-1142-75) from GE Healthcare.

Products for affinity-based protein enrichment

Specific products from GE Healthcare are listed in Table 3.1. These products are used in a wide range of applications, for example, capture of a single protein in a complex sample or enrichment of post-translationally modified proteins. They are available in several chromatography-based formats and also as magnetic beads (Fig 3.8 and 3.9).

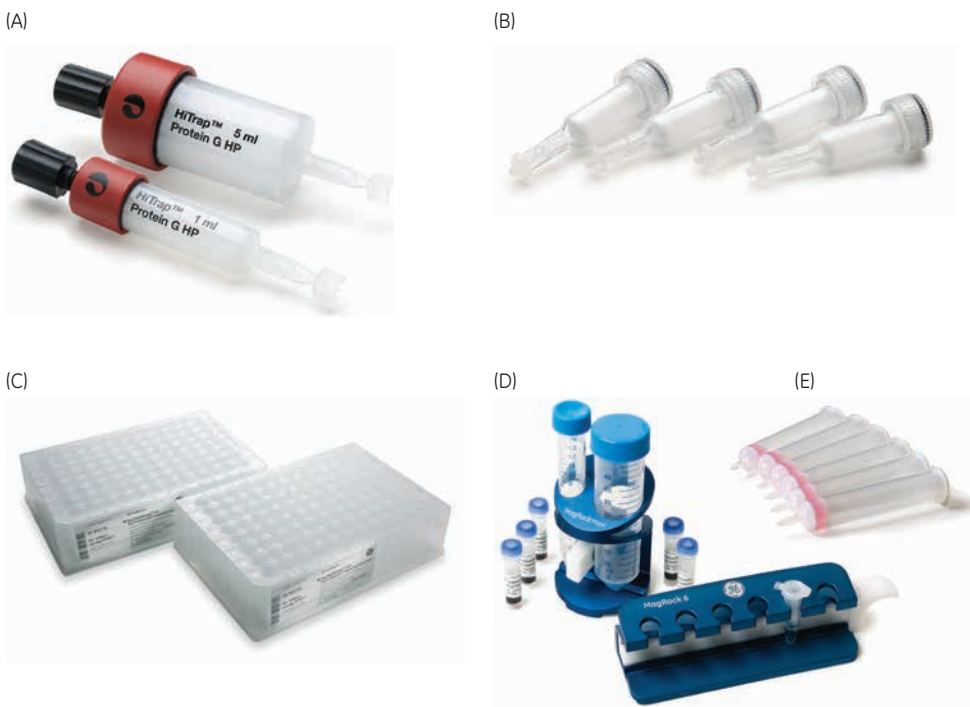

Fig 3.8. Different formats for affinity-based protein enrichment: HiTrap columns (A), SpinTrap columns (B), MultiTrap[™] plates (C), Mag Sepharose magnetic beads (D), and GraviTrap[™] columns (E).

Table 3.1. Products from GE Healthcare for affinity-based protein enrichment¹

Product	Mechanism	Suitable samples	Sample preparation format	Sample volume
NHS HP SpinTrap	Coupling via primary amine of affinity ligand	Cell lysates, serum, plasma	SpinTrap: Minispin columns (microcentrifuge)	0.2–0.6 ml
NHS Mag Sepharose			Magnetic beads (MagRack 6 and MagRack Maxi)	0.01–50 ml
HiTrap NHS-activated HP			HiTrap: 1 and 5 ml columns (LC system or syringe)	> 0.5 ml
Streptavidin HP SpinTrap	Coupling via biotinylated affinity molecule	Cell lysates, serum, plasma	SpinTrap: Minispin columns (microcentrifuge)	0.2–0.6 ml
Streptavidin Mag Sepharose			Magnetic beads (MagRack 6 and MagRack Maxi)	0.01–50 ml
Streptavidin HP MultiTrap			MultiTrap: 96-well plate (centrifugation)	0.1–0.6 ml
HiTrap Streptavidin HP			HiTrap: 1 and 5 ml columns (LC system or syringe)	> 0.5 ml
Protein A products ²	Antibody binding to protein A	Serum, plasma, ascites, or cell culture supernatants	GraviTrap gravity-flow columns	0.2–0.6 ml
			SpinTrap: Minispin columns (microcentrifuge)	0.1–0.6 ml
			MultiTrap: 96-well plate (centrifugation)	0.01–50 ml
			Magnetic beads (MagRack 6 and MagRack Maxi)	
HiTrap Protein A HP			HiTrap: 1 and 5 ml columns (LC system or syringe)	> 0.5 ml
Protein G products ¹	Antibody binding to protein G	Serum, plasma, ascites, or cell culture supernatants	GraviTrap gravity-flow columns	0.2–0.6 ml
			SpinTrap: Minispin columns (microcentrifuge)	0.1–0.6 ml
			MultiTrap: 96-well plate (centrifugation)	0.01–50 ml
			Magnetic beads (MagRack 6 and MagRack Maxi)	
HiTrap Protein G HP			HiTrap: 1 and 5 ml columns (LC system or syringe)	> 0.5 ml
HiTrap Protein L	Antibody/antibody fragment binding to protein L	Serum, plasma, ascites, or cell culture supernatants	HiTrap: 1 and 5 ml columns (LC system or syringe)	> 0.5 ml
Immuno-precipitation Starter Pack	Antibody binding to protein A or G	Serum, plasma, ascites, or cell culture supernatants	Test tube (microcentrifuge)	0.05–1.5 ml
TiO ₂ Mag Sepharose	Enrichment of phosphopeptides by TiO ₂ metal oxide affinity chromatography (MOAC)	Enzymatic digest of phosphorylated proteins	Magnetic beads (MagRack 6 and MagRack Maxi)	0.1–0.25 ml

¹ For details of available products for affinity capture of tagged proteins, see Recombinant Protein Purification Handbook: Principles and Methods (article code number 18-1142-75).

² These products are used for small-scale antibody preparation (immunoglobulin enrichment) or for immunoprecipitation using an antibody of choice. Refer to the handbook Antibody Purification: Principles and Methods (article code number 18-1037-46) for additional details.

HiTrap columns can be used with a syringe, peristaltic pump, or chromatography system such as ÄKTAmicro. Table 3.2 summarizes the flow rate specifications for HiTrap columns.

Table 3.2. Flow rates for HiTrap columns

Column	Maximum flow rate ¹	Recommended flow rate ²
1 ml column	4 ml/min	0.2–1 ml/min
5 ml column	15–20 ml/min	0.5–5 ml/min

¹ Using H₂O at 25°C

² Depending on chromatography medium

 The maximum operating pressure for HiTrap columns is 3 bar (43 psi, 0.3 MPa).

SpinTrap columns are designed for use in standard laboratory microcentrifuges.

 Lids and bottom caps are used during incubation and elution but not during equilibration and washing. Before centrifugation, remove the bottom cap and slightly open the screw cap lid (twist the cap lid ~ 90° counterclockwise).

 Make sure that the medium is fully suspended before incubating with end-over-end mixing. All incubations should normally be performed at room temperature. However, incubations may be performed at lower temperatures when a slower process is preferable.

 For the elution steps, mix by manually inverting the SpinTrap column.

MultiTrap plates are supplied in a 96-well format for higher throughput applications. These products are designed for use with centrifugation or vacuum and may be used with robotic systems. One exception is PD MultiTrap G-25 for desalting and buffer exchange; these are designed for using only with centrifugation. MultiTrap plates are discussed in further detail in Chapter 5.

Mag Sepharose magnetic beads are superparamagnetic Sepharose beads with different functionality. The beads are magnetic only when exposed to an external magnetic field, making them very useful for small-scale experiments without the need of centrifuges or chromatography systems. The beads are hydrophilic and disperse easily in aqueous solutions for binding of target proteins, during washing, and elution. Between each step, the beads are magnetized within an external magnetic field, for example, a permanent magnet, which will withdraw the beads toward the test tube wall; see Figure 3.9.

One of the main advantages of the magnetic beads separation method is the ability to vary the amount of medium as well as the sample volume. MagRack 6 and MagRack Maxi together cover a broad range of sample volumes from low-microliter to high milliliter purification scales and this further enhances the flexibility of magnetic beads separations. The ability to use a larger sample volume allows high yield in a single purification run and also efficient capture of low-expressed target proteins.

(A)



(B)



Fig 3.9. (A) MagRack 6 and (B) MagRack Maxi magnetic racks consist of an aluminum housing with a detachable magnetic bar. When the magnetic bar is inserted (center images), the high-density magnetic beads become attracted to the magnet in seconds. This allows easy removal of supernatant while the magnetic beads remain in the tube (images on the right).



Use the magnetic rack with the magnet in place for each liquid removal step.



Before application of liquid, wash buffer, elution buffer, etc., remove the magnet from the magnetic rack. After addition of liquid, allow resuspension of the beads by vortexing or manual inversion of the tube.

When processing multiple samples, manual inversion of the magnetic rack is recommended.



During incubation steps, make sure the gel beads are resuspended well and kept in solution by end-over-end mixing or by using a benchtop shaker suitable for 1.5 ml microcentrifuge tubes.



To prevent degradation of target protein, inhibition of protease activity might be required. Protease Inhibitor Mix is available from GE Healthcare (see Chapter 2).



Transfer the magnetic bead solution to a fresh microcentrifuge tube after the last washing step. This action prevents potential elution of proteins that are nonspecifically bound to the plastic material in the microcentrifuge tube.



To prevent sample degradation after elution, fractions may be placed in the freezer if SDS-PAGE is to be performed, add appropriate sample buffer.

GraviTrap columns are prepacked gravity-flow columns designed for fast and efficient manual purification of monoclonal and polyclonal antibodies, antibody fragments from cell culture supernatant, and biological fluids. The antibodies are simply captured with high specificity on protein A and protein G ligands in gravity-flow columns. No other instrument is needed because the entire process relies on the flow of gravity. The yield varies from 20 to 50 mg of purified antibodies depending on the ligand used.

Immunoglobulin enrichment

Products from GE Healthcare based on protein A and protein G are suitable for binding monoclonal or polyclonal IgG antibodies from a wide range of species; see Table 3.3.

Table 3.3. Relative binding strengths of protein A and protein G to various immunoglobulins: + indicates relative binding strength and - indicates no binding

Species	Subclass	Protein A binding	Protein G binding
Human	IgA	variable	-
	IgD	-	-
	IgE		
	IgG ₁	++++	++++
	IgG ₂	++++	++++
	IgG ₃	-	++++
	IgG ₄	++++	++++
	IgM*	variable	-
Avian egg yolk	IgY†	-	-
Cow		++	++++
Dog		++	+
Goat		-	++
Guinea pig	IgG ₁	++++	++
	IgG ₂	++++	++
Hamster		+	++
Horse		++	++++
Koala		-	+
Llama		-	+
Monkey (rhesus)		++++	++++
Mouse	IgG ₁	+	++++
	IgG _{2a}	++++	++++
	IgG _{2b}	+++	+++
	IgG ₃	++	+++
	IgM*	variable	-
Pig		+++	+++
Rabbit	no distinction	++++	+++
Rat	IgG ₁	-	+
	IgG _{2a}	-	++++
	IgG _{2b}	-	++
	IgG ₃	+	++
Sheep		+/-	++

* Purify using HiTrap IgM Purification HP columns

† Purify using HiTrap IgY Purification HP columns

Enrichment of biotinylated proteins/coupling of biotinylated affinity ligands

Streptavidin is a ligand that binds biotinylated molecules with very high affinity. Streptavidin HP SpinTrap, HiTrap Streptavidin HP, Streptavidin HP MultiTrap, and Streptavidin Mag Sepharose are used to capture biotinylated molecules. One example is capture or immobilization of biotinylated antibodies and another example is cell surface labeling using biotinylation reagents, followed by capture using the Streptavidin ligand. Some samples contain proteins that can affect performance of streptavidin-based media; naturally occurring biotin-containing proteins contribute to high background, for example. Proteins with biotin-binding functions are found in birds, reptiles, and amphibia.

Enrichment of plasminogen from human plasma

To show the performance of Streptavidin HP SpinTrap, plasminogen was enriched from human plasma using a biotinylated MAb. The concentration of the total protein was approximately 50 mg/ml, and the concentration of the plasminogen was between 0.2 and 0.3 mg/ml, which is equivalent to 0.5% of the total protein concentration. Figure 3.10 shows the SDS-PAGE result of enrichment of plasminogen using Streptavidin HP SpinTrap.

Spin column: Streptavidin HP SpinTrap
Sample: Human plasma (~ 50 mg/ml)
Sample volumes: 20 and 100 μ l
Antibody: Monoclonal mouse anti-plasminogen (biotinylated)
Binding buffer: TBS (50 mM Tris, 150 mM NaCl, pH 7.5)
Wash buffer: TBS, 2 M urea, pH 7.5
Elution buffer: 0.1 M glycine/HCl, 2 M urea, pH 3.0

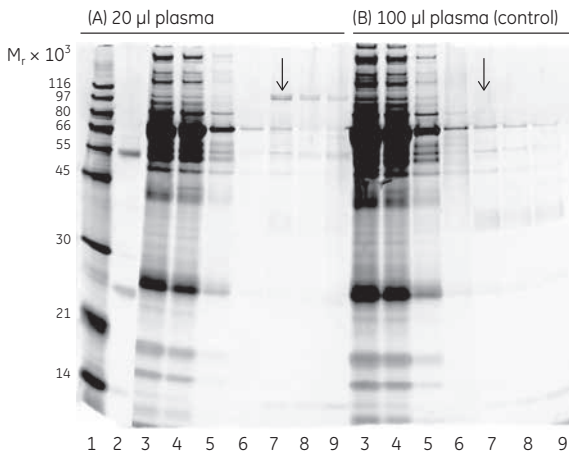

Lanes

1. LMW-SDS Marker Kit
2. Biotinylated antibody
3. Flowthrough (diluted 1:30)
4. First wash (diluted 1:10)
5. Third wash
6. Fifth wash
7. First elution
8. Second elution
9. Third elution

Fig 3.10. Enrichment of plasminogen from human plasma. (A) Analysis by SDS-PAGE (wash steps 2 and 4 have been omitted from the gel). The gel was stained with Deep Purple Total Protein Stain and scanned using Ettan DIGE Imager. The arrow indicates the position of the plasminogen (M_r 93 000) identified by MS analysis. (B) The control sample was run in an identical manner compared with the plasma sample, but without a biotinylated antibody against plasminogen.

Efficient enrichment of protein by immunoprecipitation

Streptavidin Mag Sepharose was used to enrich a sample of human transferrin spiked *E. coli* lysate. The concentration of transferrin comprised 0.15% of the total *E. coli* protein content, which corresponds to medium-level protein expression in *E. coli*. Capture of the protein of interest was achieved using a biotinylated polyclonal rabbit anti-human transferrin immobilized on the medium. SDS-PAGE analysis of the first and second elution fractions revealed a transferrin recovery of 75% and a 450-fold enrichment relative to the start material. The first elution step contained 75% of the purified protein (Fig 3.11).

Medium:	Streptavidin Mag Sepharose
Medium slurry volume:	50 μ l
Sample:	7.5 μ g/ml human transferrin in 5 mg/ml <i>E. coli</i> protein
Sample volume:	0.3 ml
Antibody:	Polyclonal rabbit anti-human transferrin (biotinylated)
Binding buffer:	Tris buffered saline (TBS: 50 mM Tris, 150 mM NaCl), pH 7.5
Wash buffer:	TBS, 2 M urea, pH 7.5
Elution buffer:	100 mM glycine-HCl, 2 M urea, pH 2.9

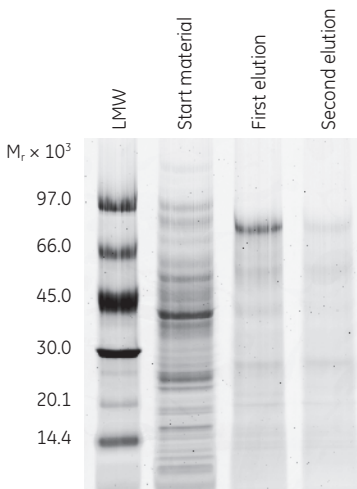

Fig 3.11. Enrichment of transferrin (M, 80 000) spiked in *E. coli* lysate. The SDS gel (reducing conditions) was stained with Deep Purple Total Protein Stain and analyzed with ImageQuant TL software. Quantitation of the eluted transferrin was performed using standard curves with known amounts of transferrin (data not shown). LMW = Low molecular weight protein markers.

Repeatable capture of biotinylated protein

In order to test the repeatability of Streptavidin Mag Sepharose, biotinylated BSA was captured in 6 replicate runs. The sample load corresponded to 80% of the total binding capacity for the medium. Protein recovery was estimated by SDS-PAGE of eluted fractions in triplicate. The SDS-PAGE gel was stained with Deep Purple Total Protein Stain and analyzed with ImageQuant TL software. Protein recovery with Streptavidin Mag Sepharose was consistently high (> 75%) and highly repeatable with a relative standard deviation (RSD) of 4% (Fig 3.12).

Medium: Streptavidin Mag Sepharose
Medium slurry volume: 100 μ l
Sample: Pure biotinylated bovine serum albumin (BSA)
Sample volume: 300 μ l
Binding buffer: Tris-buffered saline (TBS: 50 mM Tris, 150 mM NaCl, pH 7.5)
Wash buffer: TBS, 2 M urea, pH 7.5
Elution buffer: 2% SDS at 95°C

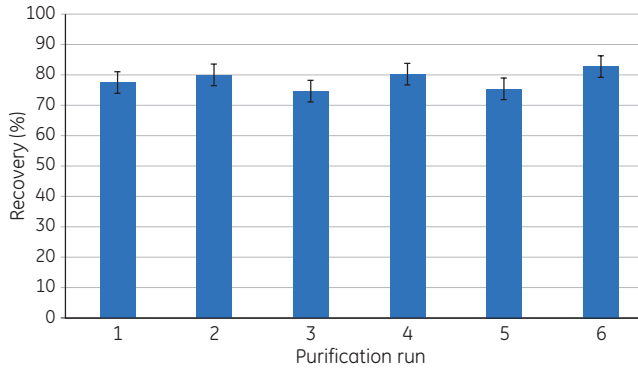

Fig 3.12. The recovery (analyzed in triplicate) of biotinylated BSA using Streptavidin BSA in six replicate runs. The error bars represent the 95% confidence interval of the SDS-PAGE analysis.

Repeatable antibody purification with high purity

MagRack 6 can be used with six samples in parallel. To demonstrate this, we conducted six replicate antibody purification runs using Protein A Mag Sepharose Xtra and Protein G Mag Sepharose Xtra magnetic beads. The load was half of the total binding capacity for Protein A Mag Sepharose Xtra and Protein G Mag Sepharose Xtra. The antibody yield was consistently high (> 80%), and the purity analyzed by SDS gel electrophoresis was > 90%. Figure 3.13 shows that the purification runs on Protein A Mag Sepharose Xtra and Protein G Mag Sepharose Xtra were highly repeatable with a relative standard deviation (RSD) of < 2%.

Magnetic beads: Protein A Mag Sepharose Xtra and Protein G Mag Sepharose Xtra
Medium slurry volume: 100 μ l
Sample: Human IgG spiked in *E. coli* lysate
Sample volume: 300 μ l
Binding/wash buffer: PBS (140 mM NaCl, 2.7 mM KCl, 10 mM phosphate, pH 7.4)
Elution buffer: 100 mM glycine, pH 2.8

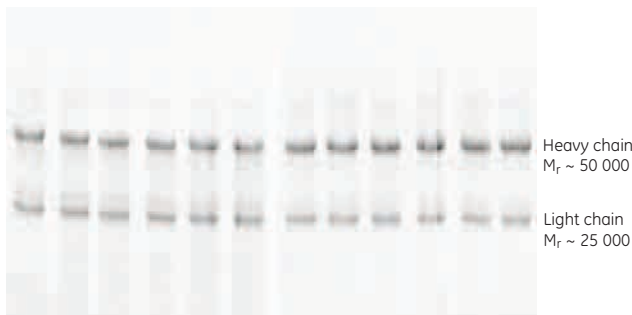

Fig 3.13. Purification of 6 samples of hIgG in *E. coli* lysate in parallel using Protein A Mag Sepharose and Protein G Mag Sepharose with MagRack 6. The SDS gel (reducing conditions) was stained with Deep Purple Total Protein Stain and analyzed with ImageQuant TL software.

Purification of low expressed mouse IgG from large sample volumes

MagRack Maxi is particularly effective at capturing low-expressed target proteins in large sample volumes. In this study, low-expressed monoclonal mouse IgG_{2b} in 50 ml of diluted cell supernatant (0.07 mg Ab/ml) was purified and concentrated the product with 1.75 ml of Protein A Mag Sepharose Xtra. The sample load was 3.5 mg and the experiment was performed in duplicate. The results show high specificity according to SDS gel electrophoresis (Fig 3.14) and a recovery of ~ 70%. The purified mouse IgG_{2b} was concentrated from 50 ml to 3.5 ml.

Magnetic beads: Protein A Mag Sepharose Xtra
Sample: Mouse IgG_{2b} from hybridoma cells
Sample volume: 50 ml (25 ml cell supernatant diluted with 25 ml binding buffer)
Medium slurry volume: 1.75 ml
Binding/wash buffer: PBS (140 mM NaCl, 2.7 mM KCl, 10 mM phosphate, pH 7.4)
Elution buffer: 100 mM glycine, pH 2.8

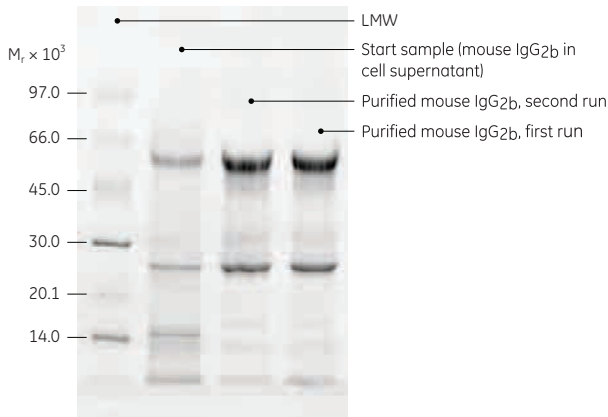

Fig 3.14. SDS-PAGE (reducing conditions) stained with Deep Purple Total Protein Stain. The purification of 50 ml of low expression mouse IgG_{2b} in a cell supernatant produced highly pure (> 90%) IgG_{2b}. LMW = LMW-SDS Marker Kit.

Reliable purification of IgG using gravity flow

rProtein A GraviTrap, Protein G GraviTrap, and rProtein A/Protein G GraviTrap are prepacked gravity-flow columns designed for fast and efficient manual purification of monoclonal and polyclonal antibodies, antibody fragments from cell culture supernatant, and biological fluids. Purification of antibodies using these gravity columns is performed in four simple steps—equilibration, sample loading, washing, and elution (Fig 3.15). Capacity can be increased from 10 ml to approximately 35 ml by connecting Labmate™ PD-10 Buffer Reservoir to the column (included in the product).

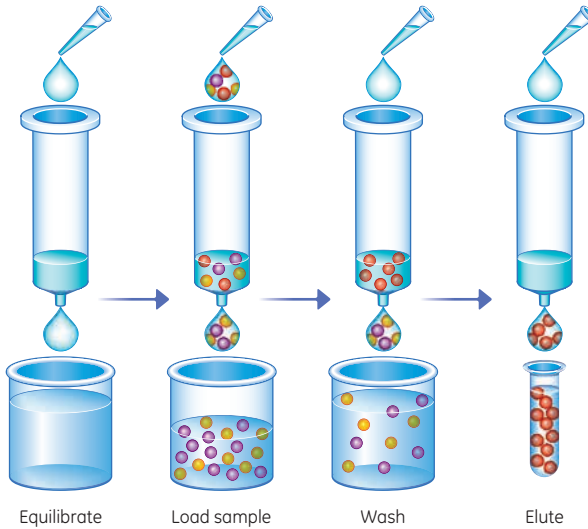

Fig 3.15. A fast and simple four-stage process for purifying immunoglobulins on rProtein A GraviTrap, Protein G GraviTrap, and rProtein A/Protein G GraviTrap columns.

GraviTrap columns can be reused for purification of the same antibody up to five times consecutively without any adverse effect on the performance of the column. We performed five consecutive purification runs on three Protein G GraviTrap columns to test the reusability of the column. IgG recovery was > 78% for all purification cycles (Fig 3.16), and IgG purity was > 95% based on SDS gel electrophoresis and analysis with ImageQuant TL software (data not shown).

Gravity-flow column: Protein G GraviTrap
 Sample: Human IgG spiked in *E. coli* lysate
 Sample load: 50% of theoretical binding capacity
 Binding/wash buffer: 20 mM sodium phosphate, pH 7.0
 Elution buffer: 0.1 M glycine-HCl, pH 2.7

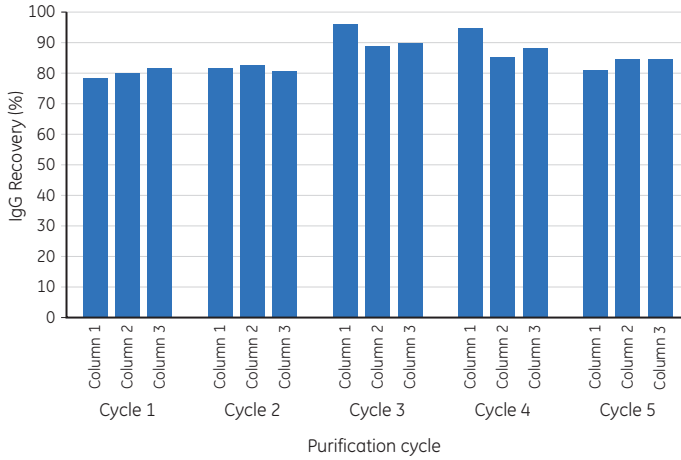

Fig 3.16. Five consecutive purification cycles on a Protein G GraviTrap column produced similar IgG recovery thus showing that the columns are highly reliable and reusable.

In a separate repeatability study, 6 replicate runs were performed on each type of GraviTrap column (i.e., six each of rProtein A GraviTrap, Protein G GraviTrap, and rProtein A GraviTrap/Protein G GraviTrap columns). The IgG recovery, calculated by absorbance measurements and extinction coefficient, was 72% to 84% depending on column type.

The results (Fig 3.17) show that the purification runs were highly repeatable with a relative standard deviation (RSD) of < 2% for the IgG recovery in all cases.

Gravity-flow column: rProtein A GraviTrap, Protein G GraviTrap, rProtein A GraviTrap/Protein G GraviTrap
 Sample: Human IgG spiked in *E. coli* lysate
 Sample load: 50% of theoretical binding capacity
 Binding/wash buffer: 20 mM sodium phosphate, pH 7.0
 Elution buffer: 0.1 M glycine-HCl, pH 2.7

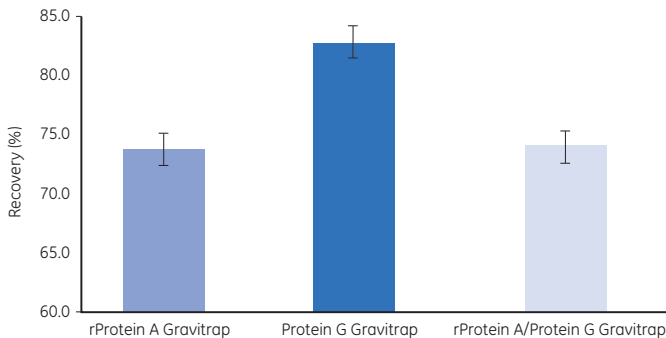

Fig 3.17. Six replicate runs on rProtein A GraviTrap, Protein G GraviTrap, and rProtein A/Protein G GraviTrap columns show that the purification runs were highly repeatable. The relative standard deviation (RSD) for the IgG recovery was < 2% for all column types. Y-error bars represent the standard error. Note that the values of the y-axis range from 60% to 85%.

Enrichment of proteins using a covalently coupled ligand

NHS-activated media are suitable for chemical coupling of ligands containing primary amine functionality, for example, proteins where the coupling can be performed via their lysine side chains or the α -amine in an unblocked N terminus. Coupling of proteins via the ϵ -amine of lysine is commonly performed in freshly prepared 0.2 M NaHCO_3 , 0.5 M NaCl buffers at pH 8.3. The result is a stable amide bond.

The coupling reaction competes with the hydrolysis reaction of NHS esters. The hydrolysis occurs more rapidly with increasing pH and in diluted protein or biomolecule solution. Other molecules containing primary amines should be avoided in the coupling solutions or removed by, for example, a desalting or buffer exchange step (Chapter 4).



NHS esters hydrolyze in aqueous solutions, and the extent of hydrolysis is determined by measuring the increase in absorbance at 260 nm caused by the release of the NHS group.



The absorbance at 260 nm is used to determine the reaction endpoint. A stabilization of the absorbance would indicate that the reagent has been completely reacted or hydrolyzed.

Buffers compatible with NHS esters are listed in Table 3.4.

Table 3.4. Buffers that are compatible with NHS esters

Buffer	pK _a (20°C)	Buffer	pK _a (20°C)
Acetate	4.75	MOPS	7.20
Succinate	5.57	HEPES	7.55
MES	6.15	Phosphate	7.21 (pK _{a2})
Carbonate	6.36	Triethanolamine	7.80
Citrate	6.39	Bicine	8.35
PIPES	6.80	Borate	9.24
Imidazole	6.95		

Enrichment of phosphorylated proteins and peptides

Phosphorylation is a common reversible PTM involved in the regulation of many essential biological processes. Phosphorylated proteins (phosphoproteins) and phosphorylated peptides (phosphopeptides) are usually present at very low concentrations and ionize poorly, making their detection by MS difficult. Phosphoproteins can be enriched using immunoprecipitation with phospho-epitope-specific antibodies. Chapter 1 includes an example of using immunoprecipitation to enrich and concentrate tyrosine-phosphorylated proteins with anti-phosphotyrosine [anti-pTyr] antibodies, cross-linked to Protein G Mag Sepharose magnetic beads. Phosphopeptides are typically enriched using metal chelates or metal oxides. See below for an example using MOAC. Note that TiO_2 Mag Sepharose from GE Healthcare is used to enrich phosphorylated peptides, and not phosphorylated proteins.

Phosphopeptide enrichment using TiO_2 Mag Sepharose

Two phosphorylated proteins (α -casein and β -casein) and one nonphosphorylated protein (bovine serum albumin [BSA]) were reduced and alkylated with TCEP and IAA, respectively, followed by trypsin digestion. A mixture of 50 pmol of each peptide in 100 μl volume was prepared and added to the beads following conditioning/equilibration with $1 \times 500 \mu\text{l}$ of binding buffer (1 M glycolic acid, 5% TFA, 80% acetonitrile). After binding for 30 min, beads were washed with $1 \times 500 \mu\text{l}$ of binding buffer and $2 \times 500 \mu\text{l}$ of washing buffer (1% TFA, 80% acetonitrile). Elution was performed with $2 \times 50 \mu\text{l}$ of elution buffer (5% ammonia). Eluate was lyophilized and dissolved in 20% acetonitrile with 0.1% trifluoroacetic acid (TFA, 20 μl) and analyzed by MALDI-ToF MS (Fig 3.9). Phosphopeptides in these protein samples were enriched, with a 2.5 ratio of phosphorylated to nonphosphorylated peptides.

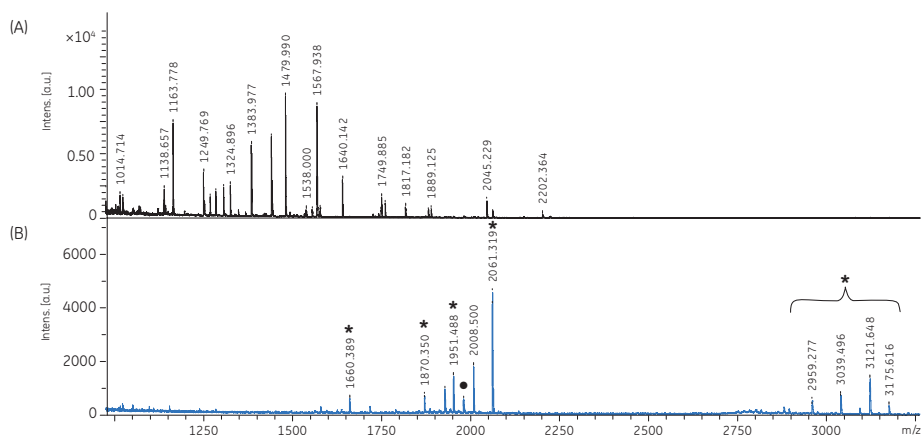

* = phosphopeptide
 • = metastable phosphopeptide

Fig 3.9. MALDI-ToF MS analysis of trypsin-digested protein mix (50 pmol each of BSA, α -casein, and β -casein) enriched using TiO₂ Mag Sepharose. Lyophilized eluates were dissolved in 20 μ l before spotting. The spectra show starting material (A) and eluates from TiO₂ Mag Sepharose (B).

Custom enrichment options

Several ways are available to customize a depletion or enrichment procedure by using one of the tools for immunoaffinity and pull-down experiments.

Generic procedure for immunoprecipitation using Protein A Mag Sepharose and Protein G Mag Sepharose magnetic beads

The following procedure is a good starting point for general immunoprecipitation experiments. The protocol can be used as it is or optimized to suit a particular application.

See Chapter 1 for a specific example using immunoprecipitation with anti-phosphotyrosine (anti-pTyr) antibodies, cross-linked to Protein G Mag Sepharose magnetic beads to enrich and concentrate tyrosine phosphorylated proteins.

Materials

Protein A Mag Sepharose or Protein G Mag Sepharose available as 1 \times 500 μ l or 4 \times 500 μ l, 20% gel slurry.

Mag Sepharose can be operated with 1.5 ml microcentrifuge tubes and a magnetic rack such as MagRack 6 or MagRack Maxi for volumes up to 50 ml.

Advance preparation

Recommended buffers for cross-link protocol

Binding buffer: TBS (50 mM tris, 150 mM NaCl, pH 7.5)

Wash buffer: TBS (optionally with 2 M urea), pH 7.5

Elution buffer: 0.1 M glycine-HCl (optionally with 2 M urea), pH 2.9

Cross-link solutions:

Cross-link solution A: 200 mM triethanolamine, pH 8.9

DMP solution: 50 mM dimethyl pimelimidate dihydrochloride (DMP) in 200 mM triethanolamine, pH 8.9

Cross-link solution B: 100 mM ethanolamine, pH 8.9



The ready to use buffers are available in a Protein A/G HP SpinTrap Buffer Kit for increased convenience.

Protocol

Prepare magnetic beads

1. Dispense the required amount of magnetic beads into a microcentrifuge tube. 25 μ l of gel slurry is equal to 5 μ l of magnetic beads, which is a good starting point for using 5 to 40 μ g of antibodies.
2. Place the microcentrifuge tube in the MagRack and remove the storage solution.

Binding and cross-linking of antibodies

1. Equilibrate the magnetic beads by adding 500 μ l of binding buffer. Resuspend the medium. Remove the liquid.
2. Immediately after equilibration, add the antibody solution (preferably in PBS or TBS). Resuspend the medium and incubate with slow end-over-end mixing for at least 15 min. Remove the liquid. Wash out nonbound antibodies by adding 500 μ l of binding buffer. Remove the liquid.
3. Change buffer by adding 500 μ l of cross-link solution A (triethanolamine buffer). Remove the liquid.
Add 500 μ l of DMP solution.
Fully resuspend the medium by manual inversion, and incubate with slow end-over-end mixing for 15 to 60 min. Remove the liquid.
Wash by adding 500 μ l of cross-link solution A (triethanolamine buffer). Remove the liquid.
Block residual crosslinking reagent by adding 500 μ l of cross-link solution B (ethanolamine buffer).
Fully resuspend the medium by manual inversion and incubate with slow end-over-end mixing for 15 min. Remove the liquid.
Remove nonbound antibody by adding 500 μ l of elution buffer. Remove the liquid.
4. Equilibrate the magnetic beads for immunoprecipitation by adding 500 μ l of binding buffer. Resuspend the medium. Repeat this step once. Remove the liquid before adding the sample.

Binding of target proteins/molecules

1. Bind target protein(s) by adding sample (diluted in, for example, binding buffer). In case of larger starting volume (> 1.5 ml), a 50 ml plastic tube could be used when binding the target protein. To recover the magnetic beads after incubation, a magnetic pickpen could be used for transferring the beads to a microcentrifuge tube. Another alternative is to spin down the beads by using a swing-out rotor.
Incubate with slow end-over-end mixing for 10 to 60 min.
Remove and collect the nonbound fraction.
2. Wash (perform this step three times in total)
Wash out nonbound material by adding 500 μ l of wash buffer. Remove the liquid.
Optional: Collect the wash fractions if troubleshooting is required.
3. Elution (perform this step two times in total)
Elute bound protein(s) by adding 10 volumes (compared to the magnetic bead volume) of elution buffer. For example, 50 μ l of buffer to 5 μ l of magnetic beads (starting from 25 μ l of medium slurry).
Fully resuspend the medium and let incubate for at least 2 min.
Remove and collect the elution fraction. Continue with the next step in the workflow.

For considerations and tips on using Mag Sepharose beads MagRack 6 and MagRack Maxi magnetic racks, see *Products for affinity-based protein enrichment* earlier in this chapter.

Choice of protocol for immunoprecipitation using Protein A or Protein G Mag Sepharose

Use the cross-link protocol

- If the desired protein/antigen has a similar molecular weight to the heavy or light chain of the antibody, causing problems with comigration in SDS-PAGE analysis.
- If the antibody interferes with downstream analyses.

Use the classic protocol

- If the antibody does not interfere with the downstream analyses and does not shadow the protein of interest in, for example, SDS-PAGE analysis.
- If faster processing is desired.

Optimization of the protocol

The optimal parameters for protein enrichment are dependent on the specific combination of biomolecules used. Optimization is required for each specific combination to obtain the desired result.

Examples of parameters that require optimization are:

- Amount of beads: The recommended starting volume is 5 μ l of magnetic beads (starting from 25 μ l medium slurry).
- Amount of antibodies: A range from 1 to 8 μ g of antibodies per μ l of magnetic beads is recommended for immunoprecipitation.
- Amount of protein (antigen) to be enriched: Empirically determined for each application.
- Incubation times: Depends on the sample stability and operating temperature.
- Choice of buffers: A more stringent wash might be needed to reduce background. Washes that are too stringent can reduce the final recovery.
- Number of washes.

References

1. Eriksson, J. and Fenyő, D. Improving the success rate of proteome analysis by modeling protein-abundance distributions and experimental designs. *Nat. Biotechnol.* **25**, 651–655 (2007).
2. Stasyk, T. and Huber, L. A. Zooming in: fractionation strategies in proteomics, *Proteomics* **4**, 3704–3716 (2004).
3. Lescuyer, P. *et al.* Comprehensive proteome analysis by chromatographic protein prefractionation, *Electrophoresis* **25**, 1125–1135 (2004).
4. Hoffman, S. A. *et al.* Higher dimensional (Hi-D) separation strategies dramatically improve the potential for cancer biomarker detection in serum and plasma. *J. Chromatogr. B* **849**, 43–52 (2006).
5. Hyung-Joo, L. *et al.* Biomarker discovery from the plasma proteome using multidimensional fractionation proteomics. *Curr. Opin. Chem. Biol.* **10**, 42–49 (2006).
6. Bodzon-Kulakowska, A. *et al.* Methods for samples preparation in proteomic research. *J. Chromatogr. B* **849**, 1–31 (2007).
7. Tang, J. *et al.* Recent development of multi-dimensional chromatography strategies in proteome research. *J. Chromatogr. B* **866**, 123–132 (2008).
8. Anderson, N. L. and Anderson, N. G. The human plasma proteome: history, character, and diagnostic prospects. *Mol. Cell. Proteomics* **1**, 845–867 (2002).
9. Hortin, G. L. *et al.* High-abundance polypeptides of the human plasma proteome comprising the top 4 logs of polypeptide abundance. *Clin. Chem.* **54**, 1608–1616 (2008).

10. Pernemalm, M. *et al.* Affinity prefractionation for MS-based plasma proteomics. *Proteomics* **9**, 1420–1427 (2009).
11. Xiangming, F. *et al.* Affinity separation and enrichment methods in proteomic analysis, *J. Proteomics* **71**, 284–303 (2008).
12. Pieper, R. *et al.* Multi-component immunoaffinity subtraction chromatography: an innovative step toward a comprehensive survey of the human plasma proteome, *Proteomics* **3**, 422–432 (2002).
13. Bjorhall, K. *et al.* Comparison of different depletion strategies for improved resolution in proteomic analysis of human serum samples. *Proteomics* **5**, 307–317 (2005).
14. Gong, Y. *et al.* Different immunoaffinity fractionation strategies to characterize the human plasma proteome. *J. Proteome Res.* **5**, 1379–1387 (2006).
15. Pernemalm, M. *et al.* Evaluation of three principally different intact protein prefractionation methods for plasma biomarker discovery. *J. Proteome Res.* **7**, 2712–2722 (2008).
16. Gao, M. *et al.* Large scale depletion of the high-abundance proteins and analysis of middle- and low-abundance proteins in human liver proteome by multidimensional liquid chromatography. *Proteomics* **8**, 939–947 (2008).
17. Azarkan, M. *et al.* Affinity chromatography: a useful tool in proteomics studies. *J. Chromatogr. B* **849**, 81–90 (2007).

Chapter 4

Ensuring compatibility in protein sample preparation workflows

Introduction and overview of available methodology

The focus of this chapter is to describe some of the techniques that are available for ensuring compatibility. These techniques are generally applied multiple times throughout a workflow and not only as a final step before analysis. In addition, these techniques are highly applicable for many other purposes, for example, to remove excessive labeling reagents after antibody labeling or to adjust conditions between chromatography steps during protein purification runs.

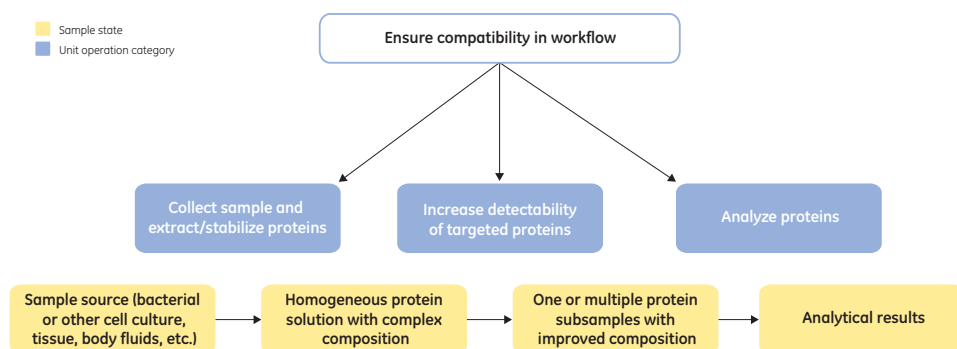

Fig 4.1. High-level workflow for protein sample preparation. The step discussed in this chapter is framed.

Protein sample preparation techniques for ensuring compatibility can be categorized in a number of ways. Often, a single technique can be used for several main purposes. In this chapter, sample preparation techniques are broken down into several categories based on purpose:

- Clarification
- Buffer exchange and desalting
- Sample cleanup
- Concentration/volume reduction

A short description of the main technology options is given below. Keep in mind the discussion in Chapter 1 relating to the contaminant tolerance of different analysis techniques (ESI-MS, MALDI-MS, 2-D gel electrophoresis, etc.).

Clarification

Clarification in the context of this handbook means removing particulate matter (cell debris, aggregated proteins, etc.) from the sample to avoid clogging filters or columns in later steps. Particulate removal is mandatory in general because particles foul filters and columns at later stages in the workflow. Particles such as cell debris, connective tissue, insoluble salts, dust, and protein aggregates can be introduced during sample preparation and can most often be removed by centrifugation or microfiltration.

Centrifugation

After a centrifugation step, solubilized proteins will remain in the supernatant whereas particulate matter will normally form a tightly packed pellet. A centrifugation force of $15\,000 \times g$ for 15 min is adequate for most samples. However, centrifugation of highly viscous samples can be difficult. Particulate centrifugation relies on a difference in the density between the particles and the liquid, so for liquids with high densities, a pellet might not form. Lipids and other fatty molecules that have a lower density than water can float on top of the sample solution after the centrifugation. In these situations, another method should be selected. If the sample is still not clear after centrifugation, use microfiltration (see below).

Microfiltration

In microfiltration, a porous membrane is used to remove particulate material from protein solutions. Commonly, a nominal pore size of $0.2\ \mu\text{m}$, $0.45\ \mu\text{m}$, or $0.5\ \mu\text{m}$ is used, and liquid solutions are filtered using pressure, vacuum, or centrifugal force. Particles in the micrometer range are retained by the filter, and the filtrate is used in subsequent steps.

GE Healthcare provides a wide range of Whatman filters including syringe filters, syringeless filters (self-contained filtration devices that do not require a syringe; see Fig 4.2 for an example), spin tubes, microwell plates, and Klari-Flex bottle-top filters. Whatman Syringe Filters are suitable for pharmaceutical, food and beverage applications, and for environmental and general laboratory use. Filter devices containing polyvinylidene fluoride (PVDF), polyethersulfone (PES), or Regenerated Cellulose (RC) are generally suitable because of their low protein-binding characteristics. High-particulate-loaded samples can require the use of a filter device with a glass prefilter (such as Whatman GD/X™ syringe filters), because the glass prefilter allows more sample to be filtered before the membrane blocks. However, glass can bind proteins and hence the suitability of such filters for a given application needs to be determined prior to use.

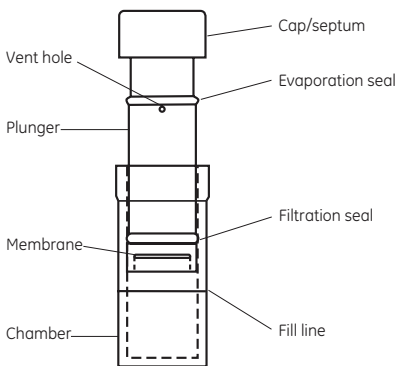

Fig 4.2. Diagram of Whatman Mini-UniPrep™ syringeless filter.



Some proteins can bind nonspecifically to filter surfaces, especially if materials other than those listed above are used. A test filtration is useful for sensitive proteins.

For HPLC analysis, syringe filters are a cost-effective way to improve the quality of HPLC analysis, improve consistency, extend column life, and reduce maintenance. By removing particulates before the sample enters the column, syringe filters allow unimpeded flow. Without particulates to create obstructions, the column will work more efficiently and last longer.

SPARTAN™ syringe filters are another type of filter that are a versatile option for use in any application requiring a chemically resistant, hydrophilic, low protein-binding membrane.

Buffer exchange and desalting

Buffer exchange and desalting involve manipulating the buffer system (including pH) and reducing the concentration of small ionic species in samples. Technology options include GF, UF, diafiltration, dialysis, precipitation, and solid-phase extraction (SPE).

Gel filtration

GF is a well-established chromatography method that separates molecules according to size and shape as they pass through a packed bed of medium. The medium consists of spherical particles with well-defined porosity and designed inertness (lack of reactivity and adsorptive properties). By designing the pore distribution such that only low-molecular-weight species can penetrate the spheres, group separation between proteins and low-molecular-weight contaminants is achieved. After the column has first been equilibrated with a desired buffer, samples can undergo buffer exchange and removal of low-molecular-weight contaminants in one quick and simple step. For further details on theory, refer to the handbook *Gel Filtration: Principles and Methods*, from GE Healthcare (article code number 18-1022-18).

Desalting or buffer exchange using GF is preferable when a complete change in buffer composition is needed. Other techniques such as diafiltration, for example, will reduce compounds in the starting material by roughly 95% after three volumes of diafiltration solution, and dialysis will require several changes of fluid. Also, the pellet obtained after protein precipitation might include other material that has been coprecipitated.

GE Healthcare offers a range of prepacked GF chromatography columns for use with a syringe, pump, or chromatography system and 96-well filter plates where purification is performed using a vacuum pump or centrifuge (see the GE Healthcare catalog/website, reference 1, and Chapter 5). The majority of these products contain Sephadex™ G-25, a GF medium that allows effective removal of low-molecular-weight-substances from proteins. Sephadex G-10 products may be used to desalt peptide and carbohydrate samples with $M_r > 700$. Refer to the handbook *Strategies for Protein Purification*, from GE Healthcare, for more information on these applications (article code number 28-9833-31).

Procedure for desalting/buffer exchange

PD MiniTrap™ and MidiTrap™ G-25 columns from GE Healthcare are used with gravity or centrifugation to desalt samples up to 0.5 ml and 1.0 ml, respectively. For smaller sample volumes in the range of 100 to 180 µl, multiple samples can be run on PD SpinTrap G-25 spin columns together with a microcentrifuge. For sample volumes from 70 to 130 µl, PD MultiTrap G-25 96-well plates can be run using centrifugation. Although possible, using PD MultiTrap G-25 with vacuum is not recommended due to reduced reproducibility compared to using centrifugation. A procedure and diagram (Fig 4.3) for use of PD SpinTrap G-25 are provided below. PD MultiTrap G-25 can be used with common automated liquid-handling stations such as Tecan™ Freedom EVO™ equipped with a centrifuge. Refer to Chapter 5 for information on increasing sample throughput for screening purposes using PD MultiTrap G-25 and to Appendix 4 for characteristics of PD-10 products prepacked with Sephadex G-25.

Materials

PD SpinTrap G-25 columns

Equilibration buffer: Buffer of choice

Advance preparation

None

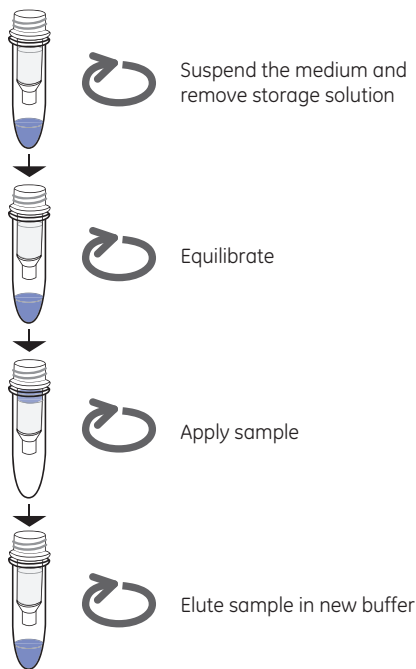



Fig 4.3. Flowchart for use of PD SpinTrap G-25.

Protocol

See product instructions for details on appropriate centrifuges. Most standard microcentrifuges are compatible with SpinTrap columns.

1. Suspend chromatography medium and remove storage solution
Vortex column. Centrifuge for 1 min at $800 \times g$.
2. Equilibrate
Add 500 μl of equilibration buffer and centrifuge for 1 min at $800 \times g$. Repeat four times.
3. Apply sample
Apply 100 to 180 μl of sample to the middle of the prepacked column.
4. Elute sample in elution buffer
Elute by centrifugation at $800 \times g$ for 2 min.

 Recovery is dependent on the type of protein or other biomolecule. Typically, the recovery is in the range of 70% to 90%. Recovery can be improved for sample volumes less than 140 μl by adding equilibration buffer up to 140 μl after the sample has fully absorbed into the column bed.

Ultrafiltration (UF)

In UF, liquid is forced against membranes with smaller and better-defined pore sizes. Molecules larger than the pores are retained (retentate) whereas smaller molecules and solvent pass through the membrane (filtrate). Pore sizes are most often defined as Molecular Weight Cutoff (MWCO) values. Buffer composition and the concentration of small contaminants can be changed by repeated dilution followed by volume reduction using UF (diafiltration).

GE Healthcare offers two types of UF products: VectaSpin and Vivaspin™. VectaSpin UF products are of the traditional type and are available in 12 000, 20 000, 30 000, and 100 000 MWCO ranges. Vivaspin products are discussed in more detail below.

Sample concentration using Vivaspin sample concentrators

In centrifuge-based UF (e.g., using Vivaspin sample concentrators from GE Healthcare), the entire process can be performed in a single tube with an upper compartment containing sample and a lower compartment separated by a semipermeable membrane with a predefined MWCO. Centrifugation is applied to force solvent through the membrane, leaving a more concentrated sample in the upper chamber. With Vivaspin sample concentrators, biological samples can be concentrated up to 30-fold. Recovery of the target molecule typically exceeds 95%. Vivaspin sample concentrators accommodate sample volumes from 100 µl to 20 ml, with a range of MWCO values from M_r 3000 to 100 000. See Figure 4.4 and Table 4.1, respectively, for images of and volume ranges for the four sizes of Vivaspin sample concentrators. Vivaspin concentrators can also be used for buffer exchange and desalting. Protocols for both concentration and buffer exchange/desalting using Vivaspin 500 are provided below. See Table 4.2 for Vivaspin 500 performance characteristics. Appendix 5 includes several tables listing maximum sample volumes, maximum centrifugation speeds, and performance characteristics of the various Vivaspin sample concentrators.



Fig 4.4. Vivaspin 500, 2, 6, and 20. All four products are available with MWCO values of 3000, 5000, 10 000, 30 000, 50 000, and 100 000.

Table 4.1. Volume ranges for Vivaspin sample concentrators

Volume range	Product
100 to 500 µl	Vivaspin 500
400 µl to 2 ml	Vivaspin 2
2 to 6 ml	Vivaspin 6
5 to 20 ml	Vivaspin 20



Membranes fitted to Vivaspin concentrators contain trace amounts of glycerin and sodium azide. Should these interfere with analysis, they can be removed by rinsing using buffer solution or deionized water through the concentrator.



Decant filtrate and concentrate before processing sample solution. If you do not want to use the prerinsed sample concentrator immediately, store it in the refrigerator with buffer or water, covering the membrane surface.



Do not allow the membrane to dry out.



Vivaspin devices should not be autoclaved because high temperatures will substantially increase the membrane MWCO. To sterilize, use a 70% ethanol solution or sterilizing by gas mixture.

Materials

Vivaspin 500 sample concentrators

Fixed-angle centrifuge with a minimum angle of 40° and 2.2 ml tube capacity

Advance preparation

Select the most appropriate membrane cutoff for your sample. For maximum recovery, select a MWCO at least 50% smaller than the molecular size of the species of interest.

Protocol

Use a centrifuge with a fixed angle. Most standard microcentrifuges are appropriate. See product instructions for details.

1. Apply sample

Apply 100 to 500 µl of sample to the top compartment. Ensure lid is fully sealed.

2. Concentrate using centrifugation

Insert the assembled concentrator into centrifuge. Centrifuge for 5 to 30 min at 15 000 × g. See product instructions for details.

3. Recover the concentrate

The concentrated sample will remain in the top chamber.

Table 4.2. Performance characteristics of Vivaspin 500

Protein/filter	Centrifugation time to 30× sample concentration (min) ¹	Recovery (%)
Aprotinin 0.25 mg/ml (M_r 6 500)		
MWCO 3000	30	96
BSA 1.0 mg/ml (M_r 66 000)		
MWCO 5000	15	96
MWCO 10 000	5	96
MWCO 30 000	5	95
IgG 0.25 mg/ml (M_r 160 000)		
MWCO 30 000	10	96
MWCO 50 000	10	96
MWCO 100 000	10	96

¹ Centrifugation time to achieve an up to 30× sample concentration with a starting volume of 500 µl at 20°C

Desalting/buffer exchange using Vivaspin 500

Materials

Vivaspin 500 sample concentrators
Fixed-angle centrifuge with a minimum angle of 40° and 2.2 ml tube capacity
Buffer of choice for final sample

Advance preparation

Select the most appropriate membrane cutoff for your sample. For maximum recovery, select a MWCO at least 50% smaller than the molecular size of the species of interest.

Protocol

Use a centrifuge with a fixed angle. Most standard microcentrifuges are appropriate. See product instructions for details.

1. Concentrate sample to desired level (see later in this chapter).
2. Empty filtrate container.
3. Refill concentrator with an appropriate solvent.
4. Concentrate the sample again, and repeat the process until the concentration of contaminating microsolute is sufficiently reduced. Typically, three wash cycles will remove 99% of initial salt content.

Evaporation

Centrifugational vacuum concentration allows easy and reproducible concentration of biological samples by removal of solvents with high vapor pressure. The technique is particularly useful for concentration of peptides, for example, prior to phosphopeptide enrichment using TiO₂ Mag Sepharose or prior to MS analysis. Many different systems are available. They are usually based on a vacuum pump connected to a centrifuge via a cold trap, which condenses solvents to prevent them from entering the pump.

Dialysis

In dialysis, a protein solution is placed inside a container where at least part of the structure consists of a semipermeable membrane with a MWCO selected by the user. By placing the container in a large liquid volume of defined composition, the properties of the protein solution can be changed, driven by osmotic pressure differences. Molecules below the MWCO limit move across the membrane until concentration differences are eliminated. The degree of contaminant removal or buffer change is controlled by the volume of the surrounding liquid. The speed of the process can be decreased by repeatedly moving the dialysis container to fresh buffer without waiting for equilibrium conditions.

Mini Dialysis Kit

Dialysis of small samples can lead to handling problems. Sample can be lost during transfer in and out of the dialysis bags. Mini Dialysis Kit from GE Healthcare offers a simple solution to the handling problems of small volume dialysis; see Figure 4.5. The kit contains dialysis tubes consisting of a sample tube with a cap that is adapted with a dialysis membrane. Sample is easily and quantitatively transferred into and out of the tube by pipetting. The capped tube is inverted in a stirred beaker containing the solution against which the sample is to be dialyzed. Salts and molecules smaller than the MWCO of the dialysis membrane rapidly exchange through the membrane. Following dialysis, the tube is centrifuged briefly. This forces the entire contents of the dialysis tube into the bottom of the tube, ensuring essentially 100% recovery. The dialyzing cap is replaced with a normal cap for storage of the dialyzed sample.

Mini Dialysis Kit is well suited for sample preparation of samples to be analyzed by, for example, 2-D electrophoresis, because the capacity of the dialysis tubes (10 to 250 μ l or 200 μ l to 2 ml) corresponds to a typical volume range for 2-D samples and because sample losses from the procedure are negligible. Dialysis times of several hours to overnight are sufficient to reduce ionic contaminants to a level that does not interfere with first-dimension IEF separation.

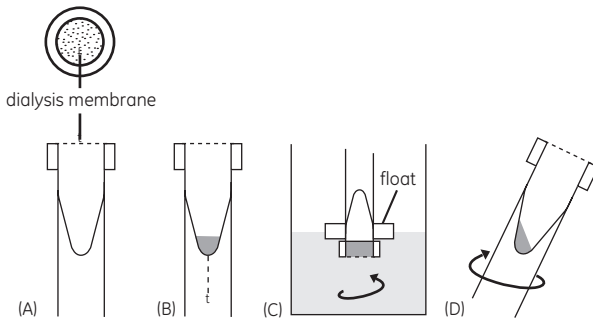

Fig 4.5. Flowchart for using Mini Dialysis Kit. (A) Cap with dialysis membrane, conical inner sample tube. (B) Introduce sample, screw on cap, and slide tube into float. (C) Invert and dialyze while stirring. (D) Spin briefly to collect sample.

Precipitation

Precipitation is caused by changes in solubility following the addition of a reagent. The precipitate is recovered by centrifugation or filtration followed by washing or solubilization. By using reagents that differentially precipitate targeted proteins but not contaminants, a cleanup and concentration effect can be achieved after resolubilization. Reagents with broad applicability include ammonium sulfate, PEG, and TCA.

Common precipitation methods are based on extremes in temperature, pH or salt concentration, or by addition of organic solvents. Acetone is sometimes used to (reversibly) precipitate proteins by reducing the hydration of the proteins. Lipids remain soluble in the acetone/water mixture and can be washed away from the protein precipitate. A drawback of using organic solvents is that some very hydrophobic proteins (membrane proteins) are soluble and will be lost in the process. A more universal precipitation method is the combined use of TCA and acetone, which has been described in various protocols elsewhere, for example, in extraction of proteins from plants (2).

SDS-PAGE sample preparation using SDS-PAGE Clean-Up Kit

SDS-PAGE Clean-Up Kit from GE Healthcare provides a rapid and quantitative method for selectively precipitating protein for SDS-PAGE analysis. It is especially useful for solving common problems involved in analysis by SDS-PAGE, for example:

- Protein concentration is too low
- Salt content is too high
- Interference from lipids, nucleic acids, and phenolics is an issue
- Band widening occurs

A low protein concentration gives a weaker signal, which will make it difficult to detect protein bands. A high salt content in the samples leads to increased conductivity especially at the beginning of the electrophoresis, resulting in possible artifacts such as skewed, crooked, or distorted bands. Different salt content in the different gel lanes can also lead to band widening. Lipophilic substances in the sample can cause smudged bands and band tailing.

Treatment of the sample with SDS-PAGE Clean-Up Kit can improve the quality of SDS-PAGE results, reducing lane distortion, increasing resolution, and yielding “publication quality” electrophoresis results. The kit can enable effective SDS-PAGE analysis of samples that are otherwise too dirty or dilute. SDS-PAGE Clean-Up Kit procedure uses a combination of precipitant and coprecipitant to quantitatively precipitate the sample proteins. The proteins are pelleted by centrifugation, and the precipitate is washed to further remove nonprotein contaminants. The mixture is centrifuged again, and the resulting pellet is resuspended, mixed with SDS-PAGE sample buffer, and heated. The sample is then ready to be loaded onto an SDS gel.

Concentrated protein samples can be prepared from sources as dilute as 1 ng/ml. Recovery is generally above 90%. Before using SDS-PAGE Clean-Up Kit, make sure that the sample is essentially free of particulate material by, for example, centrifugation.

Materials

Precipitant, Coprecipitant, Wash buffer, Wash additive, Buffer I, Buffer II, and SDS-PAGE sample buffer are supplied with the kit.

Microcentrifuge

Heat block set at 95°C to 100°C

Vortexer

Advance preparation

Remove particulate material if necessary by centrifugation at 10 000 × g for 10 min.

Chill wash buffer at -20°C for at least 1 h.

Add reductant to SDS-PAGE sample buffer, either 3.1 mg of DTT or 5 µl of β-mercaptoethanol per 100 µl.

Protocol¹

1. Precipitate proteins
Add precipitant. Vortex and incubate on ice for 15 min. Add coprecipitant and mix.
2. Pellet proteins
Centrifuge at 12 000 × g for 5 min and remove supernatant.
3. Disperse pellet
Add water and vortex.
4. Wash
Add chilled wash buffer and wash additive. Incubate for 30 min, vortexing every 10 min to remove contaminants.
5. Pellet proteins and dry
Centrifuge at 12 000 × g for 5 min and remove supernatant. Invert tube to dry.
6. Resuspend pellet
Add buffer I. Vortex and incubate on ice for 5 min.
7. Adjust pH
Add buffer II. Vortex and incubate on ice for 5 to 10 min.
8. Prepare sample for loading
Add SDS sample buffer that contains reductant. Vortex and incubate for 5 to 10 min.
9. Heat sample to denature protein
Incubate for 3 min at 95°C to 100°C.
10. Load sample onto SDS-PAGE gel.

¹ For 1 to 100 µl sample volumes containing 1 to 100 µg of protein; see product instructions if volume is larger.

2-D electrophoresis/DIGE sample preparation using 2-D Clean-Up Kit

Current methods of protein precipitation suffer from several significant disadvantages that can directly affect 2-D electrophoresis:

- Precipitation can be incomplete, resulting in the loss of proteins from the sample and thereby introducing bias into the 2-D result.
- The precipitated protein can be difficult to resuspend and often cannot be fully recovered.
- The precipitation procedure can itself introduce ions that interfere with first-dimension IEF.
- Precipitation can be time-consuming, requiring overnight incubation of the sample.

2-D Clean-Up Kit from GE Healthcare provides a method for selectively precipitating proteins for 2-D electrophoretic analysis that circumvents these disadvantages. Proteins can be quantitatively precipitated from a variety of sources without interference from, for example, detergents, chaotropes, and other common reagents used to solubilize proteins. Recovery is generally above 90%. The procedure does not result in protein spot loss, false spot gain, or changes in spot position in the 2-D gel map. The precipitated proteins are easily resuspended in 2-D sample solution and the whole procedure can be completed in less than 1 h.

Treatment of the sample with 2-D Clean-Up Kit can improve the quality of 2-D electrophoresis results, reducing streaking, background staining, and other consequences of interfering contaminants. The kit can enable effective 2-D analysis of samples that are otherwise too dirty or dilute.

The 2-D Clean-Up Kit procedure uses a combination of precipitant and coprecipitant to quantitatively precipitate the proteins in the samples. The proteins are pelleted by centrifugation, and the precipitate is washed to further remove nonprotein contaminants. The mixture is centrifuged again, and the resulting pellet can be easily resuspended into a 2-D sample solution of choice.

Materials

Precipitant, Coprecipitant, Wash buffer, and Wash additive are supplied with 2-D Clean-Up Kit.
Microcentrifuge
Vortex mixer
Rehydration or sample solution for resuspension¹

¹ See Table 4.3 for examples of suitable buffers.

Advance preparation

The protein sample should be substantially free of particulate material. Clarify by centrifugation if necessary (see above).
Chill wash buffer at -20°C for at least 1 h.

Protocol²

1. Precipitate proteins
Add precipitant. Vortex and incubate on ice for 15 min. Add coprecipitant and mix.
2. Pellet proteins
Centrifuge at 12 000 × g for 5 min and remove supernatant.
3. Wash pellet
Add coprecipitant on top of the pellet and incubate on ice for 5 min.

4. Pellet proteins
Centrifuge at 12 000 × g for 5 min. Remove the supernatant.
5. Disperse pellet
Add water to the pellet. Vortex and incubate on ice for 5 min.
6. Wash
Add chilled wash buffer and wash additive buffer. Incubate for 30 min, vortexing every 10 min to remove contaminants.
7. Pellet proteins and dry
Centrifuge at 12 000 × g for 5 min and remove the supernatant. Invert tube to dry.
8. Resuspend pellet in rehydration or sample solution of choice.
9. Sample is ready to load onto the first-dimension IEF gel.

² For 1 to 100 µl sample volumes containing 1 to 100 µg of protein; see product instructions if volume is larger.

Table 4.3. Examples of rehydration/IEF sample loading solutions

Rehydration solution containing 8 M urea

8 M urea, 2% CHAPS, 40 mM DTT, 0.5% Pharmalyte or IPG buffer, 0.002% bromophenol blue, total volume 2.5 ml

	Final concentration	Amount
Urea (FW 60.06)	8 M	1.20 g
CHAPS ¹	2% (w/v)	50 mg
Carrier ampholyte ² (Pharmalyte or IPG Buffer)	0.5% (v/v) ³	12.5 µl
DTT (FW 154.2)	40 mM	15.4 mg
Bromophenol Blue	0.002% (w/v)	5 µl of a 1% (w/v) solution
Distilled or deionized water		to 2.5 ml

This all-purpose solution gives clean and sharp 2-D separations.

Rehydration solution containing 7 M urea, 2 M thiourea

7 M urea, 2 M thiourea, 4% CHAPS, 40 mM DTT, 0.5% Pharmalyte or IPG buffer, 0.002% bromophenol blue, total volume 2.5 ml

	Final concentration	Amount
Urea (FW 60.06)	7 M	1.05 g
Thiourea (FW 76.12)	2 M	381 mg
CHAPS ¹	4% (w/v)	100 mg
Carrier ampholyte ² (Pharmalyte or IPG Buffer)	0.5% (v/v) ³	12.5 µl
DTT (FW 154.2)	40 mM	15.4 mg
Bromophenol Blue	0.002% (w/v)	5 µl of a 1% (w/v) solution
Distilled or deionized water		to 2.5 ml

¹ Other neutral or zwitterionic detergents may be used. Examples include Triton X-100, NP-40, octyl glucoside, and the alkylamidiosulfobetaine detergents ASB-14 and ASB-16.

² Use IPG buffer in the pH range corresponding to the pH range of the IEF separation to be performed, or Pharmalyte in a pH range approximating the pH range of the IEF separation to be performed.

³ Concentrations greater than 0.5% may be used for some applications. Refer to the handbook 2-D Electrophoresis, Principles and Methods for guidelines.

This is a more strongly solubilizing solution that solubilizes protein effectively and results in more protein spots in the final 2-D pattern. IEF separations performed with this solution might not be as sharp as with the previous solution, often resulting in a 2-D separation with horizontal streaking.

Figure 4.6 shows three results of an application where 2-D Clean Up Kit (C) was used to prepare the sample for the 2-D electrophoresis run. When samples were prepared using 2-D Clean-Up Kit, the overall quality of protein separation improved compared to that observed with whole cell extracts (A) or samples precipitated with acetone (B). There was less vertical streaking, suggesting improved protein transfer from strips into the gel. While distortion or other significant variations in protein migration patterns was not observed in any of the gels. Spot resolution was sharper and the number of spots was higher for samples prepared with 2-D Clean-Up Kit (Fig 4.6C). Samples prepared with 2-D Clean-Up Kit yielded 801 protein spots as opposed to 758 and 726 spots for acetone-precipitated samples and whole cell extracts, respectively. The use of 2-D Clean-Up Kit thus significantly improved resolution and recovery of proteins in 2-D electrophoresis.

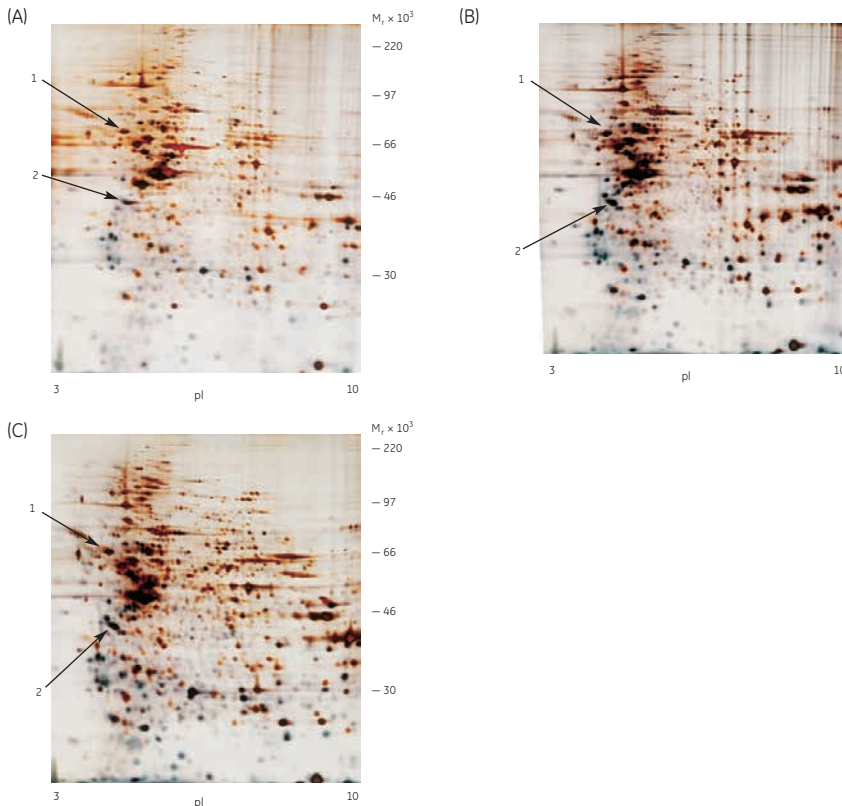

Fig 4.6. MCF7 cell proteome maps generated using whole cell extract (A), acetone-precipitated extracts (B), and extracts treated with 2-D Clean Up Kit (C). For all gels, 50 μg of protein was loaded. The pH gradient of the first-dimension electrophoresis is shown at the bottom of the gel. Migration of molecular mass markers for SDS-PAGE in the second dimension is shown on the side of the gel. Proteins used for MS analysis are indicated by arrows. Data from reference 3.

Solid-phase extraction

Solid-phase extraction is similar to adsorption chromatography, but the purpose here is to achieve separation of molecular classes. The procedure is generally performed in batch mode, and the type of solid phase and device used to retain it might differ from chromatography columns. SPE concentrates proteins and/or removes contaminants by differential binding to a solid phase with defined ligand chemistry. Either proteins are bound and contaminants washed away or contaminants are bound and proteins collected directly. Ligands include variations of those used in the common chromatography selectivities (IEX, RPC, and HIC) and specialized ones designed to remove specific contaminants (e.g., SDS removal by ceramic hydroxyapatite [4]).

Sample cleanup

Sample cleanup encompasses a set of techniques used to remove contaminants such as detergents, lipids, polysaccharides, nucleic acids, and phenols from protein solutions. Technology options are generally the same as for buffer exchange and desalting, although the protocols differ. In addition, nuclease treatment is sometimes included to reduce the molecular size of DNA and RNA. Sample cleanup is often closely integrated with protein extraction (see Chapter 2).

Nucleic acid removal

The viscosity of a sample will typically increase during lysis, especially in bacterial cells, because nucleic acids are released into the extract. To avoid or minimize complications arising from increasing viscosity, nucleases are often added during the extraction step. This increases efficiency and yield efficiency and yield, and also helps to avoid contamination and subsequent artifacts in downstream analyses.

Nucleic acid removal using Nuclease Mix

Nuclease Mix from GE Healthcare offers an effective mix of DNase and RNase enzymes, as well as the necessary cofactors for optimal nuclease activity. The mix was specifically developed for removal of nucleic acids in sample preparation for IEF/2-D electrophoresis applications in proteomic studies, but it can also be used more broadly for other applications. Nuclease Mix is compatible with Protease Inhibitor Mix (discussed in Chapter 2).

Materials

Nuclease Mix (100x solution) is provided with the product. Each Nuclease Mix contains 80 units of DNase (bovine pancreas) and 1.2 units of RNase (bovine pancreas) per 10 µl solution.

Advance preparation

None

Protocol

1. Nuclease Mix is supplied as a suspension. Vortex briefly before taking an aliquot.
2. Add 10 µl of Nuclease Mix per 1 ml of reaction mix. Vortex briefly and incubate at room temperature for 30 to 45 min.



Protease Inhibitor Mix from GE Healthcare or a cocktail of protease inhibitors can be added in the same reaction mix.

Concentration/volume reduction

Concentration/volume reduction involves adjusting the volume and global protein concentrations of diluted and/or large volume samples to match demands of the next step in the workflow. Technology options include UF, precipitation, SPE, and evaporation. These techniques have been discussed earlier in this chapter. Moreover, the described protocols can differ depending on parameters such as volume and concentration.

References

1. Selection guide: Sample preparation for analysis of proteins, peptides and carbohydrates: Desalting, Buffer Exchange, Cleanup, Concentration, GE Healthcare, 18-1128-62 AG (2008).
2. Maldonado, A. M. *et al.* Evaluation of three different protocols of protein extraction for *Arabidopsis thaliana* leaf proteome analysis by two-dimensional electrophoresis. *J. Proteomics* **71**, 461–472 (2008).
3. Stasyk, T. *et al.* Optimizing sample preparation for 2-D electrophoresis, *Life Science News* **9**, 8– 11 (2001).
4. Dong, M. *et al.* Complete removal and exchange of sodium dodecyl sulfate bound to soluble and membrane proteins and restoration of their activities, using ceramic hydroxyapatite chromatography, *Anal. Biochem.* **247**, 333–341 (1997).

Chapter 5

Increasing sample throughput/screening applications

Introduction

Sample throughput refers to the number of samples that are processed. It can apply to the number of samples processed simultaneously or to the number processed in a specified time period. The term parallel processing or multiplexing is often used when referring to samples processed simultaneously. When higher sample throughput is required, there are a number of technology options for parallel or multiplexed sample preparation.

When considering increase of throughput, it is advisable to start with a complete workflow analysis. First answer the following questions, then sketch out and evaluate designs based on the options outlined below.

- Where are the bottlenecks in terms of throughput for the particular application?
- What is the overall throughput need for the workflow, in terms of both parallel processing and samples per unit time?
- How does that propagate into needs at the level of specific unit operations? How many samples will be handled in parallel? What is the expected number of samples to be handled per unit of time? How much variation is there in these needs?
- What are the sample volumes to be handled?

There are multiple factors that can be considered for increasing the efficiency in a laboratory, and increasing sample throughput. Parallel processing is one way to accomplish this.

The format influences throughput in ways similar to how the choice of chemistry does. A proper choice can improve the speed of a unit operation or remove the need for another unit operation that would otherwise be required in the workflow. Compatibility with laboratory equipment enabling parallel handling (multipipettes, centrifuges, etc.) or integration with already existing automation infrastructure are important factors to consider. Examples of formats include (i) tubes for solution-phase operations, (ii) chromatography media in gravity-flow columns, spin columns, pipette tips, or 96-well filter plates, (iii) filter cartridges, and (iv) magnetic beads/particles.

Automation/robotics. Using robotics (1, 2) to improve throughput, in terms of both parallel processing and samples per unit of time, is an obvious strategy. However, there are additional rationales for introducing automation solutions into a workflow. Automation decreases hands-on time, thereby decreasing the need for staff or freeing up their time for other tasks. In addition, automation offers a means to standardize the process, which in turn can improve reproducibility, lower the need for training/expertise, and enable better transferability between laboratories.

Available formats

GE Healthcare provides a number of products for protein sample preparation that are amenable to increased throughput. They are based on formats such as 96-well filter plates (MultiTrap), magnetic beads (Mag Sepharose), and spin columns (SpinTrap). In addition, we provide specific products for desalting/buffer exchange and affinity-based protein enrichment, including small-scale affinity-based purification of either tagged recombinant proteins or antibodies. The use of MultiTrap plates and Mag Sepharose magnetic beads for increased throughput and screening applications is described in this chapter. The use of spin columns for screening prior to scale-up is also described.

MultiTrap 96-well filter plates

MultiTrap from GE Healthcare (Fig 5.1) is a ready-to-use, 96-well filter plate prefilled with chromatography media that simplifies screening and small-scale parallel sample preparation. MultiTrap 96-well filter plates secure consistent results with high reproducibility, both well-to-well and plate-to-plate. The format is compatible with complete automation using existing robotic solutions (such as Tecan Freedom EVO liquid-handling station or equivalent equipment). As an alternative, MultiTrap plates can be processed using a combination of multichannel pipettes and either a centrifuge or a computer-controlled vacuum manifold.

Examples of the use of MultiTrap 96-well filter plates for high-throughput screening and desalting/buffer exchange are described below.



Fig 5.1. MultiTrap 96-well filter plate in a robotic workstation.

Screening of cobalt and nickel IMAC media using His MultiTrap TALON® and His MultiTrap FF

His MultiTrap TALON are prepacked 96-well filter plates containing TALON Superflow, which gives enhanced histidine-tagged protein selectivity compared to nickel-charged media. To illustrate this, the performance in purification of GFP-(His)₆ of cobalt-charged His MultiTrap TALON was compared to nickel-charged His MultiTrap FF. Multiple purifications were performed and recovery and purity of eluted tagged protein were determined.

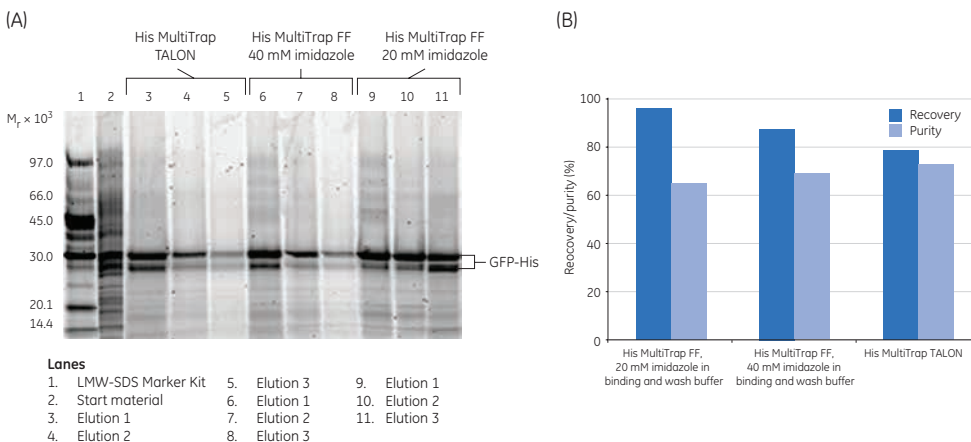

Fig 5.2. (A) SDS-PAGE analysis of elution fractions from purifications of GFP-(His)₆ (M_r 28 000) in *E. coli* protein using His MultiTrap TALON and His MultiTrap FF. The SDS-PAGE gel (ExcelGel, SDS gradient 8–18, reducing conditions) was stained with Deep Purple Total Protein Stain and analyzed with ImageQuant TL software. (B) Estimated recovery and purity of GFP-(His)₆ purification using His MultiTrap TALON and His MultiTrap FF 96-well filter plates.

SDS-PAGE analysis revealed that the purity obtained on His MultiTrap TALON (73%) was higher than that achieved with His MultiTrap FF using 0 mM imidazole in the binding buffer and only 5 mM imidazole in the wash buffer (Fig 5.2). The highest recovery of the tagged protein (96%) was achieved with His MultiTrap FF using 20 mM imidazole in the binding and wash buffer.

Desalting/buffer exchange using PD MultiTrap G-25 and manual centrifugation

Desalting of protein samples is often required in order to perform subsequent analyses such as MS or label-free study of protein interactions using Biacore systems. PD MultiTrap G-25 gives highly reproducible and efficient desalting with high levels of protein recovery, typically over 85%. Figure 5.3 shows a schematic diagram of the process. In the example, removal of NaCl from BSA was 93%, and well-to-well variation was 1% relative standard deviation (RSD; see Fig 5.4).

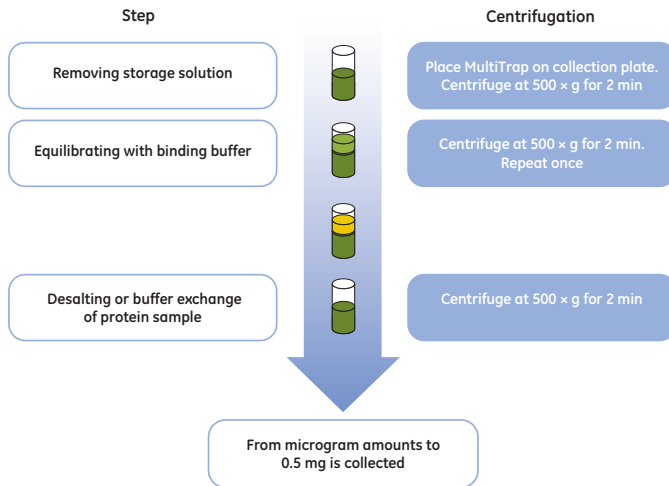

Fig 5.3. Flowchart for desalting/buffer exchange using PD MultiTrap G-25 and manual centrifugation. The schematic shows a single well in the plate.

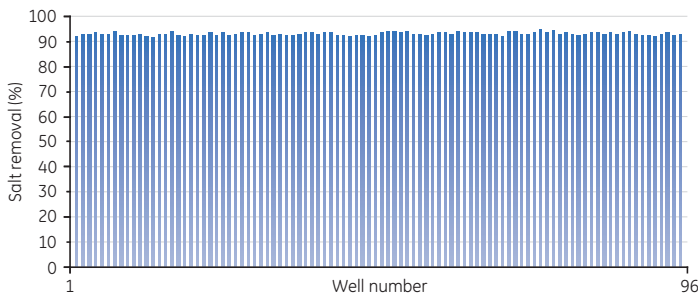

Fig 5.4. Conductivity measurements following PD MultiTrap G-25 purification. Experimental conditions: sample, 130 μ l of 1000 μ g/ μ l BSA in 1M NaCl solution per well, 1 M NaCl; sample loading volumes, 80 to 180 μ l; equilibration buffer, ultrapure water; high-throughput method; manual centrifugation; detection method; conductivity measurement.

High-throughput antibody purification using Protein A HP MultiTrap

Protein A HP MultiTrap and Protein G HP MultiTrap are versatile tools that can be used for a number of operations such as antibody screening or purifying antibodies from a variety of sources. They offer highly reproducible well-to-well performance with no detectable cross-contamination. Excellent well-to-well reproducibility is shown with a simple setup on a Tecan Freedom EVO liquid-handling station equipped with Te-VacS™ high-throughput vacuum separation module and Magellan™ data analysis software.

A study to evaluate the risk of cross-contamination on Protein A HP MultiTrap 96-well filter plates was designed. Human monoclonal IgG was purified on Protein A HP MultiTrap dispensed in a chessboard pattern (Fig 5.5), with neighboring wells left empty. The sample consisted of 200 μ l/well of pure monoclonal human IgG. Buffers included binding buffer (20 mM sodium phosphate, pH 7.0); wash buffer (20 mM sodium phosphate, pH 7.0); neutralizing buffer (1 M Tris-HCl, pH 9.0); and elution buffer (0.1 M glycine-HCl, pH 2.7). Each well was analyzed for possible cross-contamination. After elution, yields were calculated by measuring absorbance at 280 nm, and fractions from the different steps were analyzed by SDS-PAGE (Fig 5.6). Highly reproducible purification was achieved with an RSD of 1.4%, with no detectable antibody in the empty wells (Fig 5.7).

	1	2	3	4	5	6	7	8	9	10	11	12
A	S	E	S	E	S	E	S	E	S	E	S	E
B	E	S	E	S	E	S	E	S	E	S	E	S
C	S	E	S	E	S	E	S	E	S	E	S	E
D	E	S	E	S	E	S	E	S	E	S	E	S
E	S	E	S	E	S	E	S	E	S	E	S	E
F	E	S	E	S	E	S	E	S	E	S	E	S
G	S	E	S	E	S	E	S	E	S	E	S	E
H	E	S	E	S	E	S	E	S	E	S	E	S

Fig 5.5. Samples were applied in a chessboard pattern, where S indicates sample and E indicates an empty well.

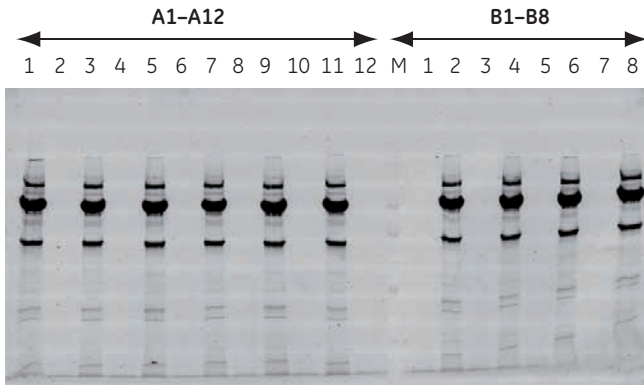

Fig 5.6. SDS polyacrylamide gel (nonreduced) of eluted monoclonal IgG from the first elution, stained using Deep Purple Total Protein Stain. Samples were taken from wells A1-A12 and B1-B8. In this test, every second well in the MultiTrap plate was empty.

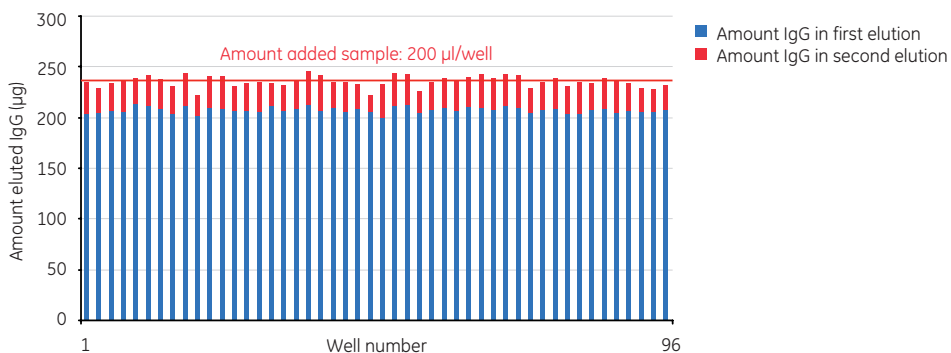

Fig 5.7. The total yield of IgG in the different wells varied with a standard deviation of 1.4%.

Mag Sepharose magnetic beads

The magnetic bead format has excellent properties for small-scale experiments. The high density of the beads allows rapid capture using magnetic devices, and samples are concentrated at the same time, which contributes to enhancing the signal in the analysis. In addition, the process is scalable to allow flexibility in volume of sample processed. MagRack 6 enables preparation of up to six samples captured in 1.5 ml microcentrifuge tubes while MagRack Maxi allows preparation of sample volumes up to 50 ml. The use of magnetic beads can also be readily automated on a variety of platforms such as with robotic systems from TECAN.

GE Healthcare offers Mag Sepharose beads for screening/purification of antibodies and phosphopeptides (TiO₂ Mag Sepharose, see Chapter 3 for application example) and for histidine-tagged proteins. Examples are described below.

Binding of human IgG to Protein G Mag Sepharose Xtra

Reproducibility and robustness are important when developing increased throughput and screening methodologies. The experiment described below shows an example of this, using Protein G Mag Sepharose Xtra. In this experiment, binding of human IgG was measured for different volumes down to 1 µl of Protein G Mag Sepharose Xtra that were dispensed into wells of a 96-well plate (Table 5.1). Each bead volume was run with 16 replicates. Processing was done automatically on a Tecan Freedom EVO robot according to the steps outlined in Figure 5.8. Twenty microgram of human IgG (gammanorm™, Octapharma AG) was used for 1 µl of the beads. PBS was used for binding, and elution was performed using 100 mM glycine-HCl, pH 2.8. Before each step, the magnetic separator was used to withdraw beads and to remove liquid, for example, buffer, sample residuals or washes.

Table 5.1. Volume of beads and amount of IgG used in experiment

Volume of beads (μl)	5	4	3	2	1	No beads
Amount of IgG loaded (μg)	100	80	60	40	20	20

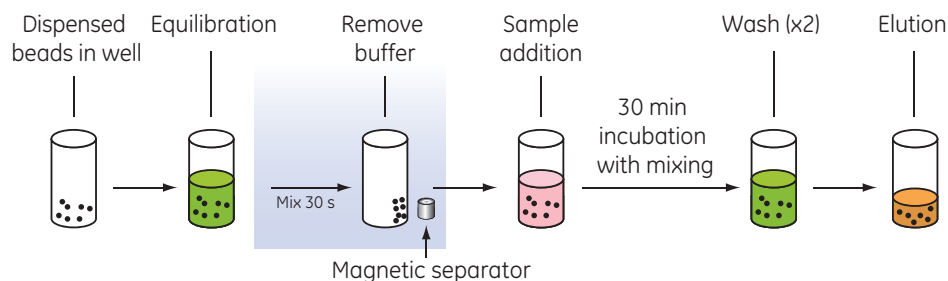
**Fig 5.8.** Steps in the binding experiment.

Absorbance at 280 nm was measured for each well to determine the amount of eluted protein (Fig 5.9). The eight rows (A to H) in the 96-well plate showed similar patterns. The wells with the same bead volume had similar amounts of eluted protein, and there was no measurable protein in wells without beads. No cross-contamination was observed.

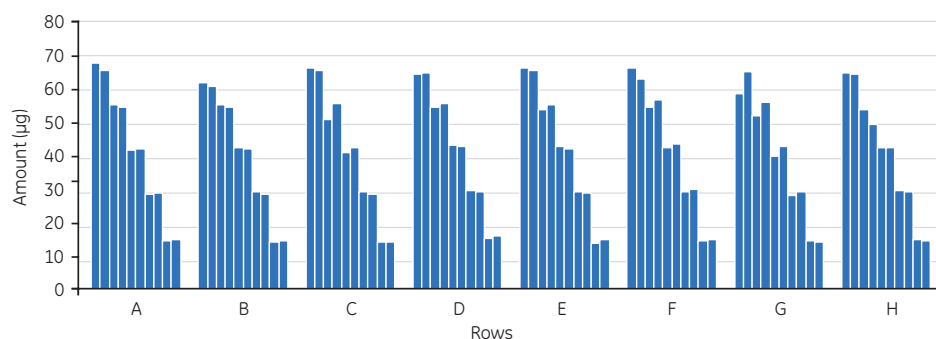
**Fig 5.9.** Amount of eluted IgG as measured by A_{280} in each well. Eight rows (A to H) of the 96-well plate are shown. IgG samples and volumes of magnetic beads were applied in duplicate according to Table 5.1.

Purification of low sample volumes of histidine-tagged GFP using His Mag Sepharose Ni

For small-scale purification/screening of histidine-tagged proteins from expression in *E. coli* cells, His Mag Sepharose Ni is an appropriate choice. In the following experiment, GFP-(His)₆ was spiked in *E. coli* lysate. The amount of loaded tagged protein varied with the volume of His Mag Sepharose Ni beads used (Table 5.2). Sixteen replicates were prepared for each bead volume. The experiment was carried out in a 96-well plate. The compositions of the binding and elution buffers were as follows: binding buffer = 20 mM sodium phosphate, 500 mM NaCl, 20 mM imidazole, pH 7.4, and elution buffer = 20 mM sodium phosphate, 500 mM NaCl, 500 mM imidazole, pH 7.4. Eluted protein was measured by absorbance at 280 nm (Fig 5.10A) and run on SDS-PAGE (Fig 5.10B). The same purity was obtained independent of the volume of the magnetic beads and sample. A very low variation in yield of GFP-(His)₆ was observed between replicates. The RSDs were between 2% and 5%.

Table 5.2. Volume of beads and amount of GFP-(His)₆ used in the experiment

Volume of beads (μl)	5	4	3	2.5	2	1
Amount of GFP-(His) ₆ loaded (μg)	94	75	56	47	38	19

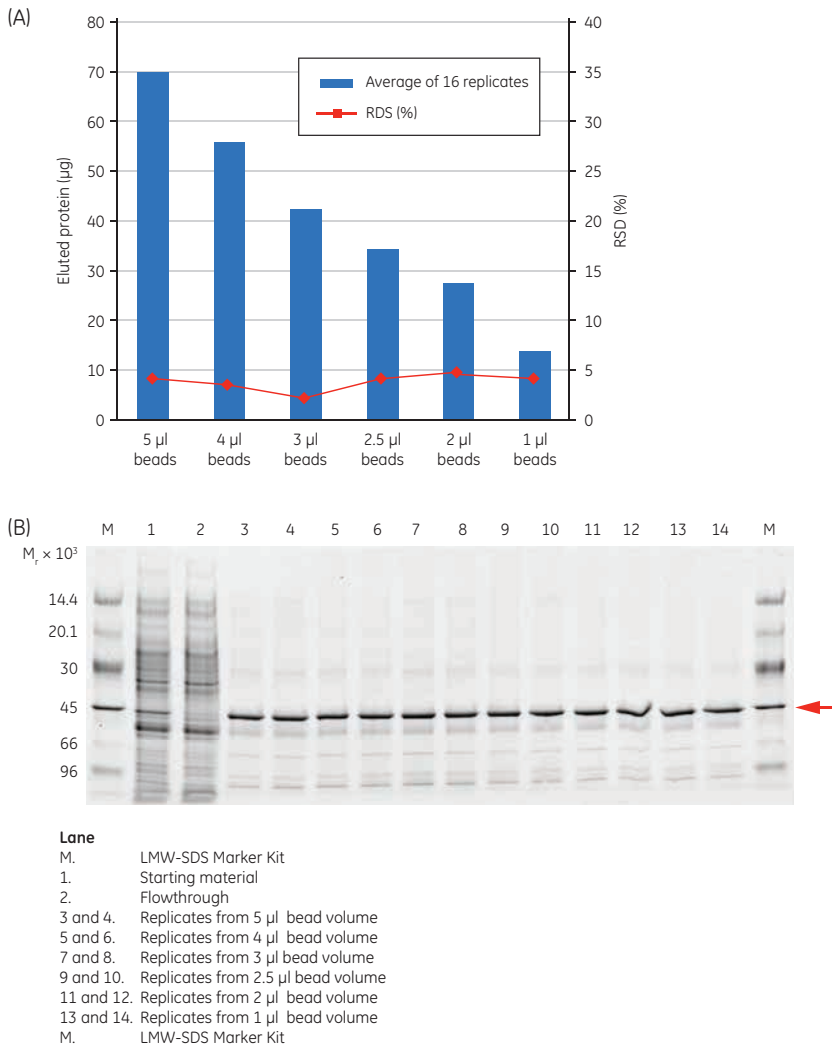

Fig 5.10. (A) Average amount of the eluted protein according to A₂₈₀ readings and the corresponding RSD. (B) SDS-polyacrylamide gel of the starting material, flowthrough, and the eluates using six different bead volumes (two replicates from each bead volume). The M_r of GFP-(His)₆ is indicated by the arrow in the SDS-PAGE image.

Screening applications

The MultiTrap and Mag Sepharose formats are especially suitable for screening purposes in high-throughput protein purification workflows for recombinant tagged proteins and antibodies. In such workflows (3, 4), a large number of proteins need characterization, and to achieve this, multiple constructs for each protein are generally screened and optimized. To handle this process efficiently, parallel handling is essential. Generic screening protocols that apply to expression and condition screening of recombinant proteins and antibodies is provided in Figure 5.11.

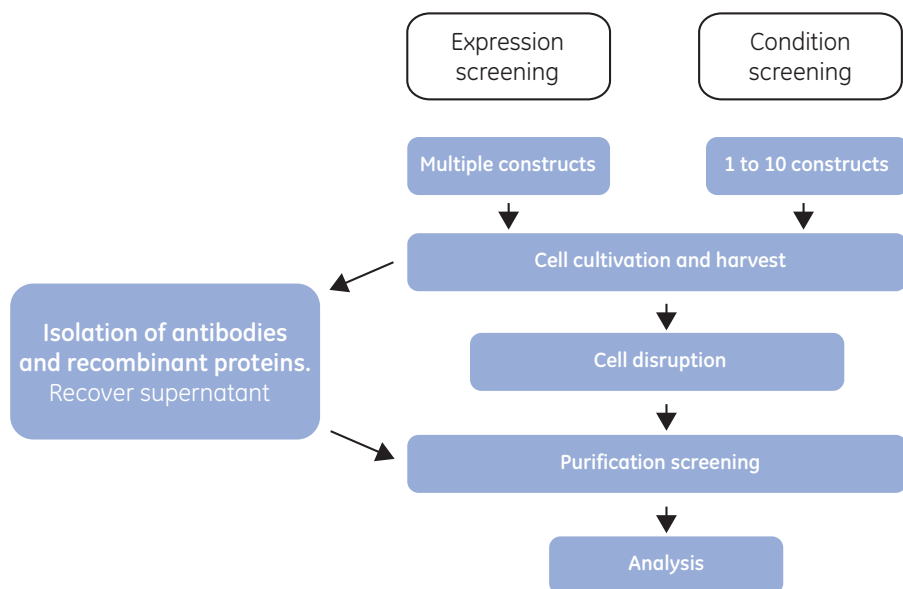

Fig 5.11. Workflows for expression and condition screening.

High-throughput screening of histidine-tagged proteins and antibodies

MultiTrap products for enrichment of GST- and histidine-tagged proteins can be loaded with up to 600 µl of sample in each well, giving microgram to low milligram amounts of enriched protein. GST MultiTrap and His MultiTrap products require short sample preparation time, because unclarified samples can be loaded directly. The same approach can be taken when it comes to screening conditions for antibody production (using Protein A HP MultiTrap/Protein G HP MultiTrap plates), where it is beneficial to screen a large number of hybridomas in parallel.

Screening of histidine-tagged proteins and antibodies can be performed in different formats such as multiwells, magnetic beads, or spin columns. Applications and examples of their use for expression and buffer screening are provided below.

Scaled-up purification of tagged and untagged recombinant proteins is outside the scope of this handbook, but in many applications, the conditions and approaches used in a smaller scale can easily be transferred to a larger format. For further information on scale-up, refer to *Recombinant Protein Purification Handbook: Principles and Methods* from GE Healthcare, article code number 18-1142-75. For more information on affinity purification and scale-up of antibodies, refer to *Affinity Chromatography: Principles and Methods*, article code number 18-1037-46.

Automated screening of soluble expression levels and protein purification efficiency using His MultiTrap HP

MAPKAP kinase 2 (MK2, M_r 38 000) is a key enzyme in the inflammation pathway and is therefore an attractive drug target for cancer therapy. Twenty-four different histidine-tagged, truncated variants of MK2 were expressed in a transient insect cell system (to obtain PTMs) and screened for soluble expression levels and purification efficiency. All 24 variants were purified in parallel using His MultiTrap HP and the Tecan liquid-handling workstation using the vacuum protocol. Eluted fractions were analyzed by SDS-PAGE (Fig 5.12), which showed large differences in the expression/purification efficiency in the different variants. For further details, see reference 5.

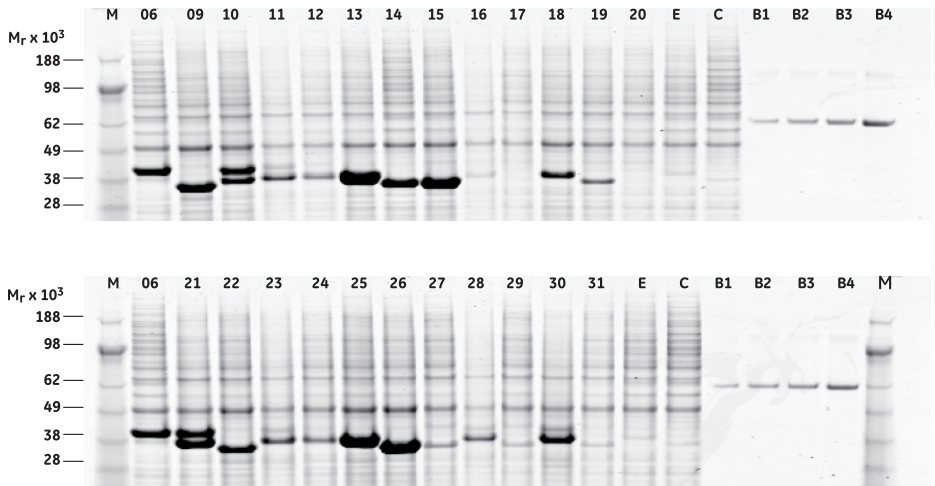

Fig 5.12. SDS-PAGE analysis of eluates of histidine-tagged truncated variants of MK2, expressed in transient insect cell system for 72 h. Lanes 06 to 31: histidine-tagged variants of kinase; E: enhanced green fluorescent protein (untagged, transfection positive control); C: nontransfected Hi5 cells; B1 to B4: 0.5, 0.75, 1.0, and 1.5 μ g of BSA, respectively; M, molecular weight markers. Acknowledgments: Mario Mann, Dr Guido Malawski, and Dr Arndt Schmitz, Bayer Schering Pharma AG, Berlin, Germany.

Automated screening of buffer conditions using His MultiTrap FF

Ninety-six buffer conditions were simultaneously screened to find optimum purification conditions of expressed target protein by a parallel, fully automated, one-step purification approach on a single MultiTrap filter plate, using Tecan Freedom EVO liquid-handling workstation and a centrifuge. Clarified *E. coli* lysates containing histidine-tagged Nurr1 ligand binding domain (His-Nurr1-LBD) (M_r 26 000), a transcription factor crucial for the development of dopamine neurons, was applied to His MultiTrap FF. Eight buffer solutions with varying pH ranging from 6.0 to 8.5 were screened (Table 5.3). For each of the eight buffers, 12 buffer solutions with varying NaCl, glycerol and β -mercaptoethanol were screened (Table 5.4). Binding buffer contained 50 mM imidazole, and elution buffer contained 500 mM imidazole. SDS-PAGE was used to determine the recovery of the target protein from the lysate (Fig. 5.13). The highest amount of purified protein was recovered in the buffer at pH 8.5 (25 mM Tris, 100 mM NaCl, 10% glycerol, pH 8.5).

Table 5.3. Buffers and pH tested

25 mM MES, pH 6.0	25 mM HEPES, pH 7.5
25 mM PIPES, pH 6.5	25 mM HEPES, pH 8.0
25 mM sodium phosphate, pH 7.0	25 mM Tris, pH 8.0
25 mM sodium phosphate, pH 7.5	25 mM Tris, pH 8.5

Table 5.4. Concentration of additives in the buffers

	1	2	3	4	5	6	7	8	9	10	11	12
NaCl (mM)	100	200	300	400	500	750	100	200	100	200	100	200
Glycerol (%)							5	5	10	10	10	10
β -mercaptoethanol (%)											0.05	0.05

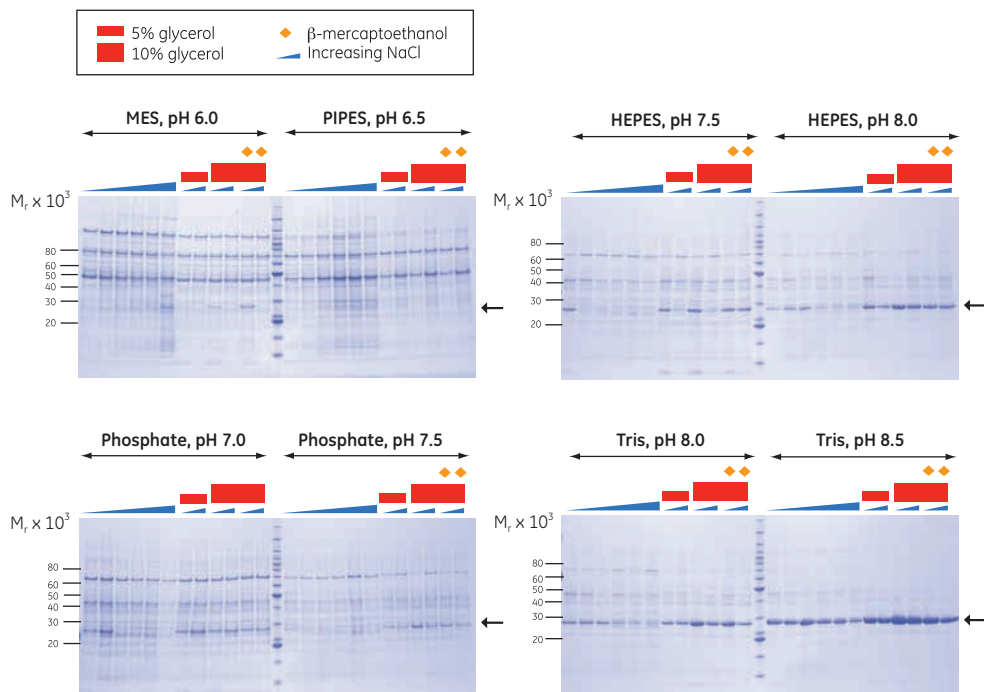

Fig 5.13. Coomassie-stained SDS-PAGE analysis of eluted His-Nurr1-LBD. For each of eight buffers (Table 5.3), 12 buffer compositions were analyzed, with varying concentrations of NaCl, glycerol, and β -mercaptoethanol (Table 5.4). The arrows indicate the position of His-Nurr1-LBD. Acknowledgements: Ruth Steel and Dr. B. L. Grasberger, Johnson and Johnson, Exton, PA, USA.

Automated screening of purification conditions for GST-GFP-(His)₆ using His Mag Sepharose Ni

The aim of this experiment was to find optimal purification conditions for GST-GFP-(His)₆. Eight different imidazole concentrations and four different sample loads were screened in triplicate using 1 μ l of His Mag Sepharose Ni beads in each well in a 96-well plate handled by a Tecan Freedom EVO robot. The sample was evaluated by absorbance measurements at 400 nm (GFP absorbs strongly at this wavelength) and on an SDS-polyacrylamide gel stained using Deep Purple Protein Stain (Fig 5.14) and analyzed with ImageQuant TL software. Not all data points are shown, because at an imidazole concentration of 200 mM imidazole, very little histidine-tagged protein was bound at all. The best balance between yield and purity of the target protein was at a concentration of 40 mM imidazole with a sample load of 50% to 100% of the total binding capacity.

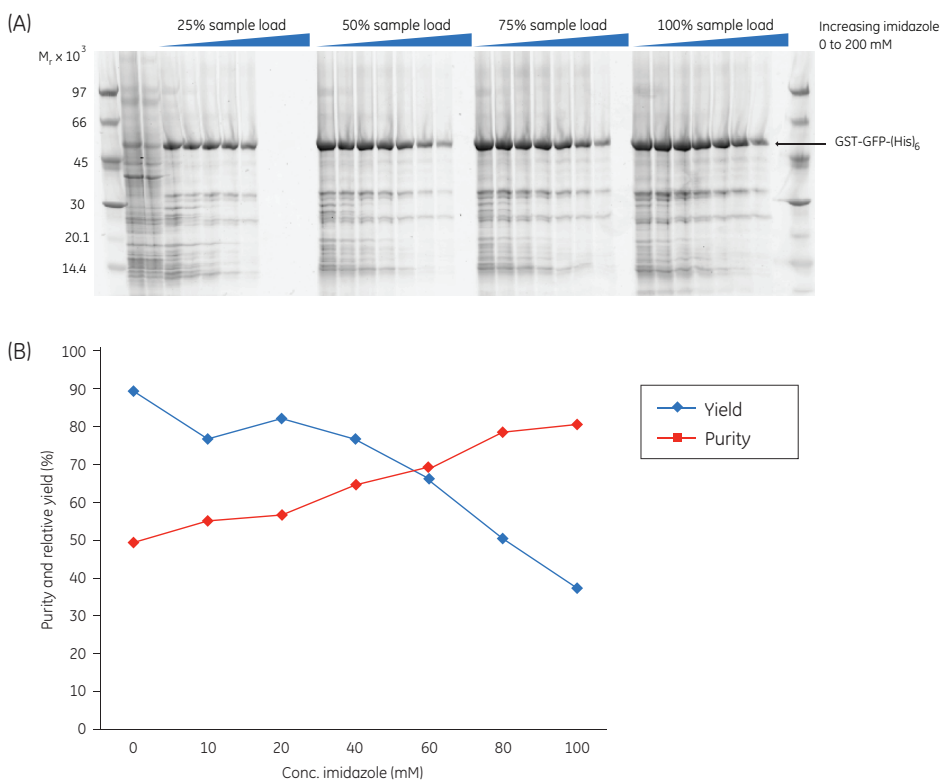

Fig 5.14. (A) SDS-polyacrylamide gel image of GST-GFP-(His)₆ enriched from a background of *E. coli* proteins. The first and last lanes are low-molecular-weight markers. Starting material and flowthrough from 75% sample load, 40 mM imidazole are in lanes 2 and 3, respectively. Proteins were detected using Deep Purple Total Protein Stain and a fluorescence scanner. GST-GFP-(His)₆ is indicated on the gel by the arrow. The gel image was analyzed with ImageQuant TL. (B) Plot showing yield and purity. Very little protein was bound at 200 mM imidazole, so these data points were excluded.

Screening of detergents for solubilizing membrane proteins using His Mag Sepharose Ni/ Membrane Protein Purification Kit

Solubilization of membrane proteins is achieved through the action of detergents, which have different critical micelle concentrations (CMC; see Table 5.5). Temperature and salt can drastically change the CMC value for a given detergent, which will affect the solubilization features of that detergent. The following example (Fig 5.15) shows screening of membrane solubilization with seven detergents. IMAC purification was performed using His Mag Sepharose Ni. Detergents and beads are included in Membrane Protein Purification Kit.

Table 5.5. Seven detergents tested for effect on solubilizing membranes

Detergent	Critical micelle concentrations (%)
Lauryldimethylamine-N-oxide (LDAO)	0.02
Octyl glucoside (OG)	0.53
Fos-Choline 12 (FOS 12)	0.05
Decyl maltoside (DM)	0.09
Dodecyl maltoside (DDM)	0.009
CYMAL™-5	0.12
Dodecyl octaethyleneglycol ether (C ₁₂ E ₈)	0.005

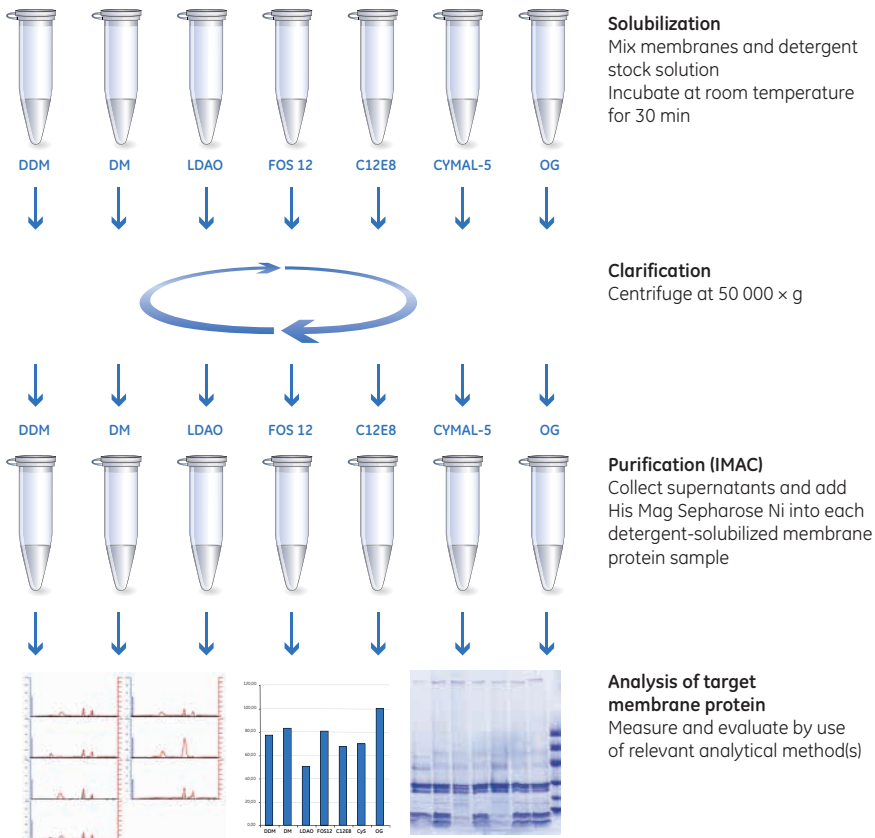

Fig 5.15. Procedure for screening various detergents using the Membrane Protein Purification Kit. Very small sample amounts are needed when using the His Mag Sepharose Ni beads included in the kit.

Screening of histidine-tagged protein secreted into eukaryotic cells using His Mag Sepharose excel

His Mag Sepharose excel are magnetic beads designed for purification of histidine-tagged proteins secreted into cell culture supernatants from eukaryotic cells such as insect cells or Chinese Hamster Ovary (CHO) cells. The magnetic beads are based on Ni Sepharose excel, a nickel-based medium for capture of histidine-tagged proteins. His Mag Sepharose excel enables direct loading of eukaryotic cell culture samples containing secreted histidine-tagged proteins without time-consuming pretreatment.

Using His Mag Sepharose excel, a study was undertaken to investigate the effects of wash buffer imidazole concentration on purity and yield during the purification of histidine-tagged prolylcarboxypeptidase (PRCP-[His]₉) expressed in High Five insect cells and secreted into insect cell-culture medium.

Figure 5.16 shows the SDS-PAGE analysis of wash and eluted pools (triplicate purifications). Increasing imidazole concentration in the wash buffer resulted in higher purity. Yield decreased, however, as imidazole concentration increased. A good balance between purity and recovery was achieved with 30 mM imidazole, and this concentration was chosen for a subsequent scale-up study.

Medium: His Mag Sepharose excel
 Medium slurry volume: 200 μ l
 Sample: PRCP-(His)₉ secreted into SAFC EX-CELL™ 405 medium, pH 6.9
 Sample volume: 10 ml
 Binding buffer: 20 mM sodium phosphate, 500 mM NaCl, pH 7.4
 Wash buffer: Binding buffer + 0 to 50 mM imidazole
 Elution buffer: 20 mM sodium phosphate, 500 mM NaCl, 500 mM imidazole, pH 7.4

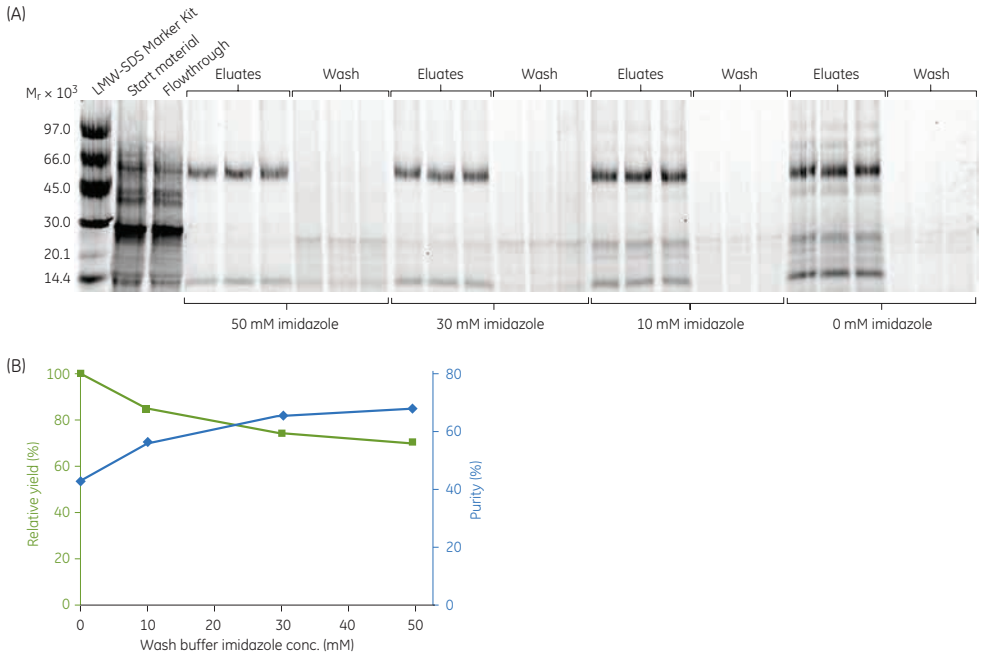

Fig 5.16. (A) SDS-PAGE analysis of eluted pools from purification of PRCP-(His)₉ (M_r , 54 600) secreted into insect cell culture supernatant using His Mag Sepharose excel. Purification was performed in triplicate using 0 to 50 mM imidazole in wash buffers. The SDS-PAGE gel was run under reducing conditions and stained with Deep Purple Total Protein Stain. (B) Yield and purity as affected by imidazole concentration in the wash buffer.

Screening of histidine-tagged protein from clarified cell lysates using His SpinTrap TALON

His SpinTrap TALON is a single-use column containing TALON Superflow (cobalt-based IMAC medium) designed for high purity, small-scale purification and screening of histidine-tagged proteins from clarified cell lysates (Fig 5.17). These spin columns are suitable for the purification of multiple samples in parallel (50 columns in each package). The parallel preparations of few or many small-scale cell lysates are performed quickly and easily with high reproducibility.

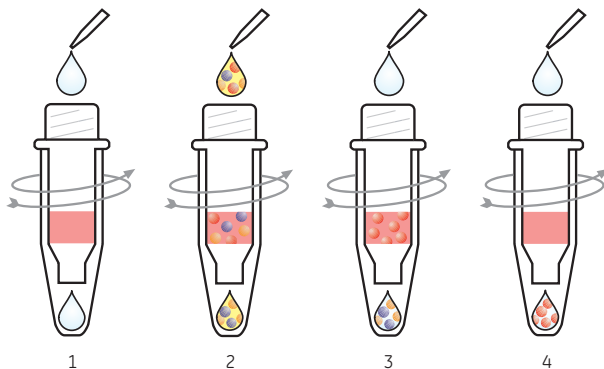

Fig 5.17. Purifying histidine-tagged proteins with His SpinTrap TALON is a simple four-stage procedure that can be performed in 10 min using a microcentrifuge: 1) After placing the column in a 2 ml microcentrifuge tube, equilibrate by adding binding buffer and centrifuge. 2) Add sample, centrifuge. 3) Wash with binding buffer, centrifuge. 4) Elute the target protein with elution by centrifugation.

One advantage of His SpinTrap TALON is the possibility to perform several purifications both simultaneously and with high repeatability. In order to investigate the repeatability, unclarified GFP-(His)₆ added to *E. coli* lysate was loaded onto ten His SpinTrap TALON columns and centrifuged.

SDS-PAGE analysis showed high purity (> 90%) of the eluted GFP-(His)₆ (Fig 5.18). Recovery was calculated with absorbance measurements and found to be highly repeatable with an average of 71% and a relative standard deviation (RSD) of 6%.

Column: His SpinTrap TALON
Sample: Unclarified GFP-(His)₆, 1 mg/ml, added to *E. coli* lysate; prepared by enzymatic lysis and sonication
Sample volume: 500 µl
Binding buffer: 50 mM NaH₂PO₄, 300 mM NaCl, pH 7.4
Wash buffer: 50 mM NaH₂PO₄, 300 mM NaCl, 5 mM imidazole, pH 7.4
Elution buffer: 50 mM NaH₂PO₄, 300 mM NaCl, 150 mM imidazole, pH 7.4
Centrifugal force: 100 × g for 30 s

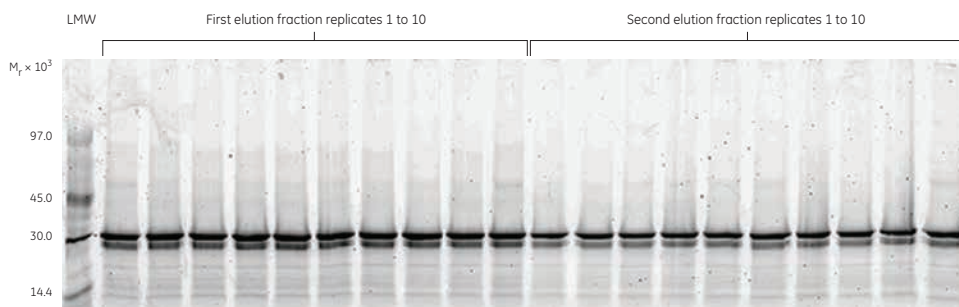

Fig 5.18. SDS-PAGE analysis of elution fractions from ten replicate purification runs of GFP-(His)₆ (M_r 28 000) using His SpinTrap TALON. The SDS-PAGE gel (reducing conditions) was stained with Deep Purple Total Protein Stain and analyzed with ImageQuant TL software. LMW = LMW-SDS Marker Kit.

Screening of elution conditions for a monoclonal human IgG using Protein A Mag Sepharose Xtra and MagRack 6

The aim of the following experiment was to find the best elution conditions for optimal recovery of a monoclonal human IgG expressed in CHO cells. The effect of pH, concentration of NaCl, and concentration of arginine (Arg) was studied in a factorial design experiment (Table 5.6 and Fig 5.19). Eighteen different elution conditions were screened on Protein A Mag Sepharose Xtra with MagRack 6. The sample load was ~ 24 mg of human IgG/ml of sedimented medium. The medium was eluted three times with elution buffer. The remaining protein was stripped with strip buffer. The recovery was determined using UV absorbance at 280 nm (Fig 5.20).

From this experiment, it was determined that the optimal buffer included elution with pH < 3.2 for optimal recovery, and that the addition of arginine increased the recovery slightly.

Table 5.6. The factorial design of experiment for screening of elution conditions

Run order	pH	NaCl (mM)	Arginine conc. (M)
1	3.5	375	0.5
2	4.0	750	0
3	3.0	750	0
4	4.0	0	1.0
5	3.5	375	0.5
6	3.0	0	0
7	4.0	0	0
8	4.0	750	1.0
9	3.5	375	0.5
10	3.0	750	1.0
11	3.0	0	1.0
12	3.0	375	0.5
13	4.0	375	0.5
14	3.5	0	0.5
15	3.5	750	0.5
16	3.5	375	0
17	3.5	375	1.0
18	3.5	375	0.5

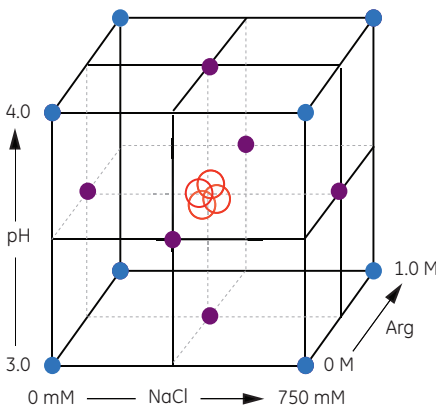

Fig 5.19. The cube represents the experimental space according to the experimental design described above (Table 5.6). The red circles represent the center points included in the design.

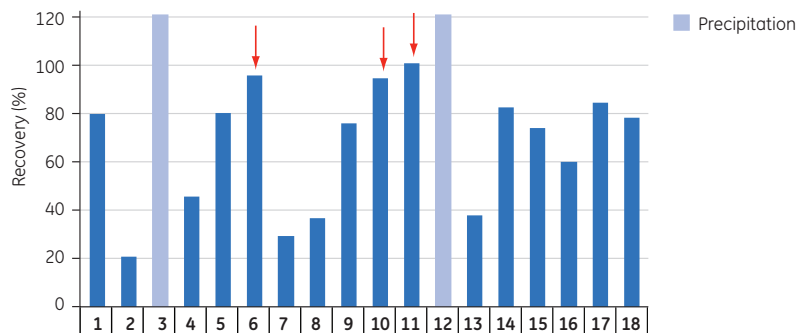

Fig 5.20. The recovery of monoclonal human IgG was measured by using absorbance at 280 nm. There was some protein precipitation in two of the samples (light blue bars), which disturbed the UV absorbance readings (outliers). The highest recoveries were obtained in samples derived from experiments indicated by the arrows.

References

1. Manjasetty, B. A. *et al.* Automated technologies and novel techniques to accelerate protein crystallography for structural genomics. *Proteomics* **8**, 612–625 (2008).
2. Alterovitz, G. *et al.* Automation, parallelism, and robotics for proteomics, *Proteomics* **6**, 4016–4022 (2006).
3. Structural Genomics Consortium *et al.* Protein production and purification. *Nat. Methods* **5**, 135–147 (2008).
4. Joachimiak, A. High-throughput crystallography for structural genomics, *Curr. Opin. Struct. Biol.* **19**, 573–584 (2009).
5. Malawski, G. *et al.*, Identifying protein construct variants with increased crystallization propensity – A case study, *Protein Science* **15**, 2718–2728 (2006).

Appendices

Appendix 1

Overview of protein analysis techniques

Two-dimensional (2-D) gel electrophoresis

2-D gel electrophoresis is a powerful and widely used technique for the analysis of complex protein mixtures extracted from biological samples. This technique separates proteins according to two independent properties in two discrete steps. The first-dimension step, IEF, separates proteins according to their pI; the second-dimension step, SDS-PAGE, separates proteins according to their MW. Each spot on the resulting two-dimensional gel potentially corresponds to a single protein species in the sample. After first- and second-dimension electrophoresis have been completed, the next step is to visualize the results of 2-D electrophoresis. This can be accomplished by staining the gel (e.g., Coomassie, silver stain, fluorescent stain) or by prelabeling the protein mixture using an isotope or fluorescent dye (e.g., CyDye DIGE dyes from GE Healthcare). A digital image is generally acquired by an imager and analyzed using dedicated software. In this way, thousands of different proteins can be separated, and information such as the protein pI, the apparent molecular weight, and relative amounts of each protein can be obtained. A special form is 2-D DIGE, based on the Ettan DIGE system from GE Healthcare (1); it is based on size- and charge-matched fluorescent dyes for covalent prelabeling of protein mixtures. Three distinct CyDye DIGE dyes—Cy2, Cy3, and Cy5—enable co-electrophoresis of up to three samples on the same gel. This increases throughput and enables the use of an internal standard on each gel to minimize experimental variation.

Analysis of 2-D results can be an end point, but normally gel spots of interest to the analytical purpose are analyzed by MS (generally MALDI-MS) to identify the corresponding proteins (see below). For more information, refer also to *2-D Electrophoresis: Principles and Methods* (article code number 80-6429-60).

Mass spectrometry (MS)

MS is today a central technique for protein analysis in research and increasingly also for clinical applications. This started with the invention of ionization techniques compatible with proteins and peptides. Two different techniques are available to create an ion source that can transform proteins and peptides into gas phase ions: MALDI and ESI. By combining an ion source with mass analyzers of different kinds (time-of-flight [ToF], ion trap, quadrupole, and ion cyclotron or hybrid combinations thereof) the molecular species present are separated in gas phase and detected with accurate mass values. Some of these mass analyzers (tandem mass spectrometers, or MS/MS) are also capable of selecting specific ions and initiating structure-specific fragmentation followed by mass measurement of the resulting ions. Currently, bottom-up approaches are most common for detailed analysis. Proteins are treated (digested) with sequence-specific proteases (commonly trypsin) to generate peptide mixtures that are then interrogated to build up information about the original proteins present. Three main modes of MS based on this approach can be defined:

1. Protein identification of 2-D gel spots

Gel spots of interest are excised from the gel, in-gel digested and made compatible with the selected ionization technique. Normally, identification is performed using the process of peptide mass fingerprinting (PMF) on MALDI-ToF instruments. In PMF, a list of peptide masses

are compared to theoretical lists generated from sequence databases. Based on the degree of similarity, protein identities are assigned with different degrees of probability. This approach is only valid for pure proteins, and the more stringent process of using sequence-specific fragmentation data is increasingly replacing PMF for identification (for example using MALDI-ToF/ToF).

2. Global LC-MS/MS

Protein mixtures are digested and fed to tandem mass spectrometers after separation of the peptide mixtures using nano-LC (generally RPC or a combination of IEX and RPC). Protein identification is enabled by acquiring sequence-specific fragmentation data from the eluted peptides. Mass spectrometers with fast scan rates are used to enable interrogation of as many peptides as possible at each point in the chromatogram. Generally, samples are labeled (either at the protein or peptide level) with isotope-coded tags, and depending on the technique used, two or more samples are merged before analysis. By comparing peak areas (MS or MS/MS level) for peptides that are identical except for their different tags, relative quantitation data can be extracted.

3. Targeted LC-MS/MS

In contrast to the global approach, targeted LC-MS/MS analysis is tailored for a defined set of proteins. For each targeted protein, one or a few tryptic peptides are selected as quantitation probes. Optimally, probes should be proteotypic (present in only one protein in the assayed sample) and have favorable analytical properties. To achieve absolute quantitation, an internal standardization approach is used; stable isotope-labeled analogs of the proteotypic peptides are spiked into the samples in defined amounts before LC-MS/MS analysis. Spiked samples are separated in similar ways as in global approaches, but mass spectrometers can be programmed to focus on the defined proteotypic peptides only. Instrument types (i.e., triple quadrupole) capable of selected reaction monitoring (SRM) are especially suitable in this approach. Signals from specific fragmentation transitions (pairs of intact peptide ion/fragment ion) are monitored, whereby quantitation accuracy, sensitivity, and dynamic range can be improved compared with global approaches.

As high-performance mass spectrometers continue to evolve, top-down approaches to protein analysis in complex samples are starting to emerge (2, 3). Full-length proteins are introduced and their structure deduced by complex fragmentation reactions in the gas phase. However, sensitivity is substantially lower compared with bottom-up approaches, and large proteins or truly complex mixtures cannot currently be handled.

Western blotting

Western blotting—also known as “protein blotting” or “immunoblotting”—is a well-established technique used to detect a target protein in a mixture of proteins. This technique can determine the expression levels of the target protein in selected cells or tissues, either under normal or experimental conditions. Compared with ELISA-like techniques, a wider range of proteins can potentially be targeted for detection, because denaturing conditions can be utilized during extraction. Proteins in a mixture are first separated by electrophoresis, generally by MW using 1-D PAGE. The proteins are then transferred (blotted) from the gel to a membrane (nitrocellulose or PVDF) for easier handling and manipulation. Following the blotting step, the target protein is probed using antibodies. The primary antibody, which is specific for the target protein, can be labeled or unlabeled. To maximize sensitivity and signal-to-noise ratio, most Western blotting procedures use an unlabeled primary antibody and a conjugated or labeled secondary antibody (the secondary antibody is specific for the primary antibody). The secondary antibody can be labeled with a fluorescent dye or conjugated with an enzyme. Typical enzymes used are horseradish peroxidase (HRP) and alkaline phosphatase (AP), both of which use a detection reagent to

generate a signal that can be quantitated. The signal can be the production of an insoluble dye (chromogenic) or the generation of light (chemiluminescent or chemifluorescent). Finally, proteins are detected using the appropriate detection reagents to generate a signal that can be quantitated. For chromogenic techniques, the signal is captured directly on the membrane. For fluorescent, chemiluminescent, or chemifluorescent techniques, the signal is captured using an imaging system. The acquired image is quantitated using image-analysis software.

References

1. Marouga, R. *et al.* The development of the DIGE system: 2D fluorescence difference gel analysis technology. *Anal. Bioanal. Chem.* **382**, 669–678 (2005).
2. Kelleher, N. L. Top-down proteomics. *Anal. Chem.* **76** 197A–203A (2004).
3. Sze, S. K. *et al.* Top-down mass spectrometry of a 29-kDa protein for characterization of any posttranslational modification to within one residue. *Proc. Natl. Acad. Sci. U.S.A.* **99** 1774–1779 (2002).

Appendix 2

Protein determination

Proteins generally have UV absorbance maxima at 190 nm caused by the peptide bonds and at 280 nm caused by the aromatic amino acids Trp and Tyr. Protein structure (secondary, tertiary, and quaternary) and solution conditions (e.g., pH, ionic strength) affect the absorbance spectrum. Coenzymes and cofactors enable light absorbance at other wavelengths.

The absorbance is proportional to the protein concentration, c :

$$A = c \times E \times l$$

where A = absorbance, E = absorbance coefficient, and l = path length of the cuvette in cm. E varies greatly for different proteins. Absorbance at 280 nm (A_{280}) is typically used for concentration determination.

Some proteins, however, lack Trp and Tyr amino acid residues and therefore do not give absorbance at 280 nm. For these proteins, measurement can be made at 205 nm (absorbance from peptide bonds). This value is used instead of the maximum at 190 nm because various technical limitations are introduced at this low wavelength. In addition to peptide bonds some amino acid side chains also contribute to absorbance at 205 nm. For a detailed protocol, refer to *Current Protocols in Protein Science*, Unit 3.1 (Spectrophotometric Determination of Protein Concentration), John Wiley and Sons, Inc. (date varies, as it is updated regularly).

Absorbance measurements

Absorbance should be measured within the linear range of the absorbance photometer. Keeping the values between 0.2 and 1.0 is recommended, but absorbance values of up to 1.5 to 2 can sometimes be used (see the manual for the instrument used). If higher values are obtained, dilute the sample. A quartz cuvette, or a plastic cuvette or multiwell plates made for UV measurement, should be used. Remember to correct for the pathlength of the cuvette. Fill enough sample to cover the light path.

1. Prepare the instrument. Warming up might take time.
2. Measure A_{280} for the buffer used (blank).
3. Measure A_{280} for the protein sample. If the value is above the limit for the instrument, dilute the sample.
4. For correction of light scattering contribution at A_{280} , also measure A_{330} for the protein sample and correct as described on the following page.

Protein concentration calculations

The protein concentration, c , in mg/ml is calculated by:

$$c = A_{280} / (E_{280, 1 \text{ mg/ml}} \times l)$$

The absorbance coefficient ($E_{280, 1 \text{ mg/ml}}$) corresponds to the A_{280} of a 1 mg/ml solution of the protein and varies between proteins. $E_{280, 1 \text{ mg/ml}}$ can be determined 1) by measuring the absorbance of the protein in a solution of known concentration or 2) by the theoretical calculation:

$$E_{280, 1 \text{ mg/ml}} = (5500n_{\text{Trp}} + 1490n_{\text{Tyr}} + 125n_{\text{S-S}}) / M$$

where n_{Trp} , n_{Tyr} and $n_{\text{S-S}}$ are the number of Trp and Tyr residues, $n_{\text{S-S}}$ is the number of disulfide bonds (S-S bonds) in the protein sequence, and M is the molecular weight of the protein. Coenzymes and cofactors also contribute. Examples of values for $E_{280, 1 \text{ mg/ml}}$ include 0.67 for BSA, 1.37 for IgG, and 2.64 for lysozyme.

Light scattering correction of the A_{280} value can be made by:

$$A_{280} = A_{280} \text{ (measured)} - 1.929 \times A_{330} \text{ (measured)}$$

Nucleic acids have absorbance at 280 nm (maximum at 260 nm). If the presence of nucleic acids is suspected, the protein concentration can be estimated (with less accuracy) according to Christian, W. and Warburg, O. *Biochemische Zeitung* **310**, 384 (1941):

$$C \text{ (mg/ml)} = 1.55 \times A_{280} - 0.76 \times A_{260}$$

The constants 1.55 and 0.76 refer to a specific protein used by Christian and Warburg. For best accuracy, the factors should be determined for the target protein at hand. Refer to the NanoVue Plus User Manual, Code No. 28-9574-75 AD from GE Healthcare.



Make sure that plastic cuvettes or multiwell plates are suitable for UV absorbance measurements and that the cuvette surface is kept clean on the outside.



The sample should be free from particles or opalescence. Remove particles by centrifugation or filtration.



Adding cold solutions into the cuvette can cause fogging of the cuvette surface, and warming of a solution in the cuvette can cause air bubbles.

Purity determination by SDS-PAGE analysis

Materials

6× SDS loading buffer: 0.35 M Tris-HCl (pH 6.8), 10.28% (w/v) SDS, 36% (v/v) glycerol, 0.6 M DTT (or 5% β-mercaptoethanol), 0.012% (w/v) bromophenol blue. Store in 0.5 ml aliquots at -80°C.

Protocol

1. Add 2 μl of 6× SDS loading buffer to 5 to 10 μl of supernatant from crude extracts, cell lysates, or purified fractions as appropriate.
2. Vortex briefly and heat for 5 min at between 90°C and 100°C.
3. Load the samples onto an SDS-polyacrylamide gel.
4. Run the gel and stain with Coomassie Blue or silver stain (PlusOne Silver Staining Kit).



The percentage of acrylamide in the SDS-gel should be selected according to the expected molecular weight of the protein of interest (see Table A2.1).

Table A2.1. Relationship between percentage acrylamide in SDS gel and M_r of the protein

Acrylamide in resolving gel (%)	Separation size range ($M_r \times 10^3$)
Single percentage:	
5	36–200
7.5	24–200
10	14–200
12.5	14–100
15	14–60 ¹
Gradient:	
5–15	14–200
5–20	10–200
10–20	10–150

¹ Larger proteins fail to move significantly into the gel

Appendix 3

Chromatography columns for use with ÄKTAmicro chromatography system

Table A3.1. IEX columns recommended for the ÄKTAmicro system

Column	IEX columns			
	Binding capacity/column (mg)	Average particle size (µm)	Max flow rate (ml/min)	Working pH range
Mini Q™ PC 3.2/3	< 1.5	3	1	3 to 11
Mini Q 4.6/50 PE	< 5	3	2	3 to 11
Mini S™ PC 3.2/3	< 1.5	3	1	3 to 11
Mini S 4.6/50 PE	< 5	3	2	3 to 11
Mono Q PC 1.6/5	< 3	10	0.4	2 to 12
Mono Q 5/50 GL	< 50	10	3	2 to 12
Mono Q 4.6/100 PE	< 85	10	3	2 to 12
Mono Q 10/100 GL	< 400	10	10	2 to 12
Mono Q HR 16/10	< 1000	10	10	2 to 12
Mono S™ PC 1.6/5	< 3	10	0.4	2 to 12
Mono S 5/50 GL	< 50	10	3	2 to 12
Mono S 4.6/100 PE	< 85	10	3	2 to 12
Mono S 10/100 GL	< 400	10	10	2 to 12
Mono S HR 16/10	< 1000	10	10	2 to 12
Mono P™ 5/50 GL	< 10	10	3	2 to 12
Mono P 5/200 GL	< 40	10	2	2 to 12

Table A3.2. GF columns recommended for the ÄKTAmicro system

Column	GF columns				
	Loading capacity/column (µl)	Average particle size (µm)	Fraction range (M _r)	Max flow rate (ml/min)	Working pH range
Superdex™ Peptide PC 3.2/30	2–25	13	100–7000	0.15	1 to 14
Superdex Peptide 10/300 GL	25–250	13	100–7000	1.2	1 to 14
Superdex 75 PC 3.2/30	2–25	13	3000–70 000	0.1	3 to 12
Superdex 75 5/150 GL	4–50	13	3000–70 000	0.7	3 to 12
Superdex 75 10/300 GL	25–250	13	3000–70 000	1.5	3 to 12
Superdex 200 PC 3.2/30	2–25	13	10 000–600 000	0.1	3 to 12
Superdex 200 5/150 GL	4–50	13	10 000–600 000	0.8	3 to 12
Superdex 200 10/300 GL	25–250	13	10 000–600 000	1	3 to 12
Superose™ 6 PC 3.2/30	2–25	13	5000–5 000 000	0.1	3 to 12
Superose 6 10/300 GL	25–250	13	5000–5 000 000	1	3 to 12
Superose 12 PC 3.2/30	2–25	11	1000–300 000	0.1	3 to 12
Superose 12 10/300 GL	25–250	11	1000–300 000	1.5	3 to 12

Table A3.3. RPC columns recommended for the ÄKTAmicro system

Column	RPC columns			
	Loading capacity/column	Average particle size (μm)	Max flow rate (ml/min)	Working pH range
SOURCE™ 5RPC ST 4.6/150	200 mg bacitracin	5	1	1 to 12
SOURCE 15RPC ST 4.6/100	17 mg BSA	15	2.5	1 to 12
RESOURCE™ RPC 1 ml	10 mg BSA	15	10	1 to 12
RESOURCE RPC 3 ml	30 mg BSA	15	10	1 to 12
μ RPC C2/C18 ST 4.6/100	9 mg proteins/peptides	3	1.2	2 to 8

Appendix 4

Characteristics of Vivaspin sample concentrators

Vivaspin concentrators are designed for use with biological fluids and aqueous solutions. Compatible pH range is pH 1 to 9. For chemical compatibility details, see Table A4.1. For maximum sample volume, recommended maximum centrifugation speeds, and performance characteristics, see Tables A4.2 to A4.7.

Table A4.1. Vivaspin chemical compatibility (2 h contact time)

Solution	Compatibility¹	Solution	Compatibility¹
Acetic acid (25%)	Yes	Mercaptoethanol (1 M)	No
Acetone (10%)	No	Nitric acid (10%)	Yes
Acetonitrile (10%)	No	Phosphate buffer (1 M)	Yes
Ammonium sulfate (saturated)	Yes	PEG (10%)	Yes
Benzene (100%)	No	Pyridine (100%)	No
Chloroform (1%)	No	Sodium carbonate (20%)	Yes
Dimethyl sulfoxide (5%)	Yes	Sodium deoxycholate (5%)	Yes
Ethanol (70%)	Yes	SDS (0.1 M)	Yes
Ethyl acetate (100%)	No	Sodium hydroxide (2.5 M)	No
Formaldehyde (30%)	Yes	Sodium hypochlorite (200 ppm)	Yes
Formic acid (5%)	Yes	Sodium nitrate (1%)	Yes
Glycerine (70%)	Yes	Sulfamic acid (5%)	Yes
Guanidine HCl (6 M)	Yes	Tetrahydrofuran (5%)	No
Hydrocarbons, aromatic	No	Toluene (1%)	No
Hydrocarbons, chlorinated	No	Trifluoroacetic acid (10%)	Yes
Hydrochloric acid (1 M)	Yes	Tween 20 (0.1%)	Yes
Imidazole (300 mM)	Yes	Triton X-100 (0.1%)	Yes
Isopropanol (70%)	Yes	Urea (8 M)	Yes
Lactic acid (5%)	Yes		

¹ Yes indicates chemical compatibility and No indicates chemical incompatibility and that the solution is not recommended

Table A4.2. Maximum sample volumes for different Vivaspin concentrators

Vivaspin	Fixed angle	Swing bucket
500	500 µl	Do not use
2	2 ml	3 ml
6	6 ml	6 ml
20	14 ml	20 ml

Table A4.3. Recommended maximum centrifugation speed (× g) for different Vivaspin concentrators

	Vivaspin 500	Vivaspin 2	Vivaspin 6	Vivaspin 20
Fixed angle				
3000–50 000 MWCO	15 000	12 000	10 000	8000
100 000 MWCO	15 000	9000	6000	6000
Swing bucket				
3000–50 000 MWCO	N.A.	4000	4000	5000
100 000 MWCO	N.A.	4000	4000	3000

Table A4.4. Performance characteristics of Vivaspin 500

Protein/filter	Centrifugation time to 30× sample concentration (min) ¹	Recovery (%)
Aprotinin 0.25 mg/ml (M_r 6500)		
3000 MWCO	30	96
BSA 1.0 mg/ml (M_r 66 000)		
5000 MWCO	15	96
10 000 MWCO	5	96
30 000 MWCO	5	95
IgG 0.25 mg/ml (M_r 160 000)		
30 000 MWCO	10	96
50 000 MWCO	10	96
100 000 MWCO	10	96

¹ Centrifugation time to achieve an up to 30× sample concentration with a start volume of 500 µl at 20°C.

Table A4.5. Performance characteristics of Vivaspin 2

Protein/filter	Centrifugation time to 30× sample concentration (min) ¹	Recovery (%)
Aprotinin 0.25 mg/ml (M_r 6500)		
3000 MWCO	50	96
BSA 1.0 mg/ml (M_r 66 000)		
5000 MWCO	12	98
10 000 MWCO	8	98
30 000 MWCO	8	97
IgG 0.25 mg/ml (M_r 160 000)		
30 000 MWCO	10	96
50 000 MWCO	10	96
100 000 MWCO	8	95

¹ Centrifugation time to achieve up to 30× sample concentration with a start volume of 2 ml at 20°C.

Table A4.6. Performance characteristics of Vivaspin 6

Protein/filter	Centrifugation time to 30× sample concentration ¹			Recovery (%)
	Swing bucket (min)	Recovery (%)	25° Fixed angle (min)	
Cytochrome C 0.25 mg/ml (M _r 12 400)				
3000 MWCO	-	-	90	97
BSA 1.0 mg/ml (M_r 66 000)				
5000 MWCO	20	98	12	98
10 000 MWCO	13	98	10	98
30 000 MWCO	12	98	9	97
IgG 0.25 mg/ml (M_r 160 000)				
30 000 MWCO	18	96	15	95
50 000 MWCO	17	96	14	95
100 000 MWCO	15	91	12	91

¹ Centrifugation time to achieve up to 30× sample concentration with a start volume of 6 ml at 20°C.

Table A4.7. Performance characteristics of Vivaspin 20

Protein/filter	Centrifugation time to 30× sample concentration ¹			Recovery (%)
	Swing bucket (min)	Recovery (%)	25° Fixed angle (min)	
Cytochrome C 0.25 mg/ml (M _r 12 400)				
3000 MWCO	110	97	180	96
BSA 1.0 mg/ml (M_r 66 000)				
5000 MWCO	23	99	29	99
10 000 MWCO	16	98	17	98
30 000 MWCO	13	98	15	98
IgG 0.25 mg/ml (M_r 160 000)				
30 000 MWCO	27	97	20	95
50 000 MWCO	27	96	22	95
100 000 MWCO	25	91	20	90

¹ Centrifugation time to achieve up to 30× sample concentration with a start volume of 20 ml (swing bucket rotor) or 14 ml (fixed angle 25° rotor) at 20°C.

Appendix 5

Characteristics of PD products prepacked with Sephadex G-25

Table A5.1. Characteristics of PD products prepacked with Sephadex G-25





	PD MultiTrap G-25	PD SpinTrap G-25	PD MiniTrap G-25	PD MidiTrap G-25	PD-10 Desalting Columns
Volume of prepacked medium	500 µl/well	700 µl	2.1 ml	3.45 ml	8.3 ml
Packed bed dimensions			0.97 × 2.8 cm	1.3 × 2.6 cm	1.45 × 5.0 cm
Well/column volume	800 µl	1000 µl	5 ml	8.5 ml	13.5 ml
Void volume	~ 150 µl	~ 200 µl	~ 0.5 ml	~ 1.0 ml	2.5 ml
Maximum sample volume	130 µl	180 µl	0.5 ml	1.0 ml	2.5 ml
Volume of eluted sample (gravity)			1.0 ml	1.5 ml	3.5 ml
Volume of eluted sample (spin) ¹	130 µl	180 µl	0.5 ml	1.0 ml	2.5 ml
Recovery ²	70% to 90%	70% to 90%	70% to 95%	70% to 95%	70% to > 95%
Desalting capacity	> 85%	> 85%	> 90%	> 90%	> 90%
Plate/column material	polypropylene and polyethylene	polypropylene and polyethylene	polypropylene and polyethylene	polypropylene and polyethylene	polypropylene and polyethylene
Storage solution	20% ethanol	0.05% Kathon™	0.15% Kathon	0.15% Kathon	0.15% Kathon
Storage temperature	4°C to 30°C	4°C to 30°C	4°C to 30°C	4°C to 30°C	4°C to 30°C

¹ Applied volume = eluted volume

² Biomolecule dependent

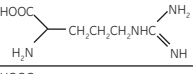
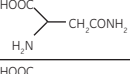
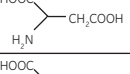
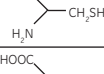
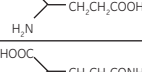
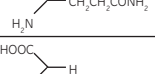
Appendix 6

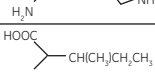
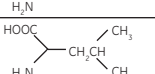
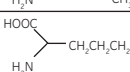
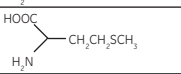
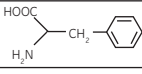
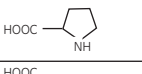
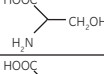
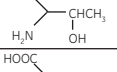
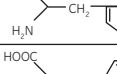
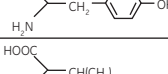
Amino acid data

Amino acid	Three-letter code	Single-letter code	Structure
Alanine	Ala	A	
Arginine	Arg	R	
Asparagine	Asn	N	
Aspartic Acid	Asp	D	
Cysteine	Cys	C	
Glutamic Acid	Glu	E	
Glutamine	Gln	Q	
Glycine	Gly	G	
Histidine	His	H	
Isoleucine	Ile	I	
Leucine	Leu	L	
Lysine	Lys	K	
Methionine	Met	M	
Phenylalanine	Phe	F	
Proline	Pro	P	
Serine	Ser	S	
Threonine	Thr	T	
Tryptophan	Trp	W	
Tyrosine	Tyr	Y	
Valine	Val	V	

Formula	M _r	Middle unit residue (-H ₂ O) Formula	M _r	Charge at pH 6.0-7.0	Hydrophobic (nonpolar)	Uncharged (polar)	Hydrophilic (polar)
C ₃ H ₇ NO ₂	89.1	C ₃ H ₅ NO	71.1	Neutral	■		
C ₆ H ₁₄ N ₄ O ₂	174.2	C ₆ H ₁₂ N ₄ O	156.2	Basic (+ve)			■
C ₄ H ₈ N ₂ O ₃	132.1	C ₄ H ₆ N ₂ O ₂	114.1	Neutral		■	
C ₄ H ₇ NO ₄	133.1	C ₄ H ₅ NO ₃	115.1	Acidic (-ve)			■
C ₃ H ₇ NO ₂ S	121.2	C ₃ H ₅ NOS	103.2	Neutral		■	
C ₅ H ₉ NO ₄	147.1	C ₅ H ₇ NO ₃	129.1	Acidic (-ve)			■
C ₅ H ₁₀ N ₂ O ₃	146.1	C ₅ H ₈ N ₂ O ₂	128.1	Neutral		■	
C ₂ H ₅ NO ₂	75.1	C ₂ H ₃ NO	57.1	Neutral		■	
C ₆ H ₉ N ₃ O ₂	155.2	C ₆ H ₇ N ₃ O	137.2	Basic (+ve)			■
C ₆ H ₁₃ NO ₂	131.2	C ₆ H ₁₁ NO	113.2	Neutral	■		
C ₆ H ₁₃ NO ₂	131.2	C ₆ H ₁₁ NO	113.2	Neutral	■		
C ₆ H ₁₄ N ₂ O ₂	146.2	C ₆ H ₁₂ N ₂ O	128.2	Basic (+ve)			■
C ₅ H ₁₁ NO ₂ S	149.2	C ₅ H ₉ NOS	131.2	Neutral	■		
C ₉ H ₁₁ NO ₂	165.2	C ₉ H ₉ NO	147.2	Neutral	■		
C ₅ H ₉ NO ₂	115.1	C ₅ H ₇ NO	97.1	Neutral	■		
C ₃ H ₇ NO ₃	105.1	C ₃ H ₅ NO ₂	87.1	Neutral		■	
C ₄ H ₉ NO ₃	119.1	C ₄ H ₇ NO ₂	101.1	Neutral		■	
C ₁₁ H ₁₂ N ₂ O ₂	204.2	C ₁₁ H ₁₀ N ₂ O	186.2	Neutral	■		
C ₉ H ₁₁ NO ₃	181.2	C ₉ H ₉ NO ₂	163.2	Neutral		■	
C ₅ H ₁₁ NO ₂	117.1	C ₅ H ₉ NO	99.1	Neutral	■		

Product index

Untagged protein enrichment

NHS HP SpinTrap	63
NHS Mag Sepharose	63
HiTrap NHS-activated HP	63
Streptavidin HP SpinTrap/ MultiTrap	61, 64-65
Streptavidin Mag Sepharose	63, 67, 68-69
Protein A HP MultiTrap	63, 95-96, 100
Protein A Mag Sepharose	63, 69, 74
Protein G HP MultiTrap	63, 95, 100
Protein G Mag Sepharose	20, 73-74, 76
HiTrap Protein A/Protein G HP	63
Immunoprecipitation Starter Pack	63
Phos SpinTrap Fe	63
TiO ₂ Mag Sepharose	61, 66-67
MagRack 6	63, 64-65, 69, 74-75, 97
MagRack Maxi	63, 64-65, 70, 74-75, 97

Small-scale antibody purification

Protein A HP SpinTrap	63
Protein A HP MultiTrap	63, 95-96, 100
rProtein A GraviTrap	63, 71-72
Protein G GraviTrap	63, 71-72
rProtein A/Protein G GraviTrap	63, 71-72
Protein A Mag Sepharose Xtra	63, 69-70, 107
Protein G HP MultiTrap	63, 95-96
Protein G Mag Sepharose Xtra	60, 69, 97
HiTrap Protein A/Protein G HP	63
HiTrap Protein L	63
HiTrap IgM Purification HP	63
HiTrap IgY Purification HP	63

Desalting/buffer exchange/cleanup

PD MidiTrap/MiniTrap G-25	81, 119
PD SpinTrap G-25	81-82, 119
PD MultiTrap G-25	60, 64, 81, 95, 119
PD MidiTrap/MiniTrap G-10	73
Mini Dialysis Kit	85-86
2-D Clean-Up Kit	88-90
SDS-PAGE Clean-Up Kit	86-87
Vivaspin sample concentrators	83-85, 116-118

Enzyme regulation

Protease Inhibitor Mix	20, 35, 43, 45, 48, 65, 91
Nuclease Mix	35, 43, 91

Fractionation

2-D Fractionation Kit	55-56
2-D Quant Kit	47, 48, 49-51

Histidine-tagged protein capture

His Mag Sepharose Ni	98-99, 102-104
His MultiTrap HP/FF	94-95, 100, 101
His SpinTrap TALON	105-106
His MultiTrap TALON	94-95, 100
TALON Superflow	94, 105
His Mag Sepharose excel	104-105
Ni Sepharose excel	104
Membrane Protein Purification Kit	103-104

GST-tagged protein capture

GST MultiTrap FF/4B	100
---------------------	-----

Protein depletion

HiTrap Albumin & IgG Depletion	59
--------------------------------	----

Lysis/protein extraction

Sample Grinding Kit	31, 47-48
Yeast Protein Extraction Buffer Kit	44-46
Mammalian Protein Extraction Buffer	42-43
2-D Protein Extraction Buffers	47-48
illustra triplePrep Kit	54

Protein concentration

Vivaspin sample concentrators	83-84, 85, 116-118
-------------------------------	--------------------

ÄKTAmicro and compatible columns

58, 64, 114-115

Filters and filtration systems

Vivaspin sample concentrators	83-85, 116-118
Whatman Klari-Flex Bottle-Top System	38, 80
Whatman GD/X (syringe filters)	80
Whatman VectaSpin filters (for UF)	83
Whatman Mini-UniPrep filters (syringeless)	80

Related literature

	Code number
Handbooks	
Affinity Chromatography: Principles and Methods	18-1022-29
Antibody Purification: Principles and Methods	18-1037-46
Gel Filtration: Principles and Methods	18-1022-18
Hydrophobic Interaction and Reversed Phase Chromatography: Principles and Methods	11-0012-69
Ion Exchange Chromatography and Chromatofocusing: Principles and Methods	11-0004-21
Recombinant Protein Purification Handbook: Principles and Methods	18-1142-75
GST Gene Fusion System	18-1157-58
Purifying Challenging Proteins	28-9095-31
2-D Electrophoresis: Principles and Methods	80-6429-60
Electrophoresis in Practice	18-1124-59
Nucleic Acid Sample Preparation for Downstream Analyses: Principles and Methods	28-9624-00
Strategies for Protein Purification	28-9833-31
Selection guides	
Selection guides can be a great help in planning purifications, for the novice as well as the more experienced worker.	
Protein and nucleic acid sample preparation	28-9337-00
Protein and peptide purification	18-1128-63
Sample preparation for analysis of proteins, peptides, and carbohydrates—desalting, buffer exchange, cleanup, concentration	18-1128-62
Protein and nucleic acid sample prep—get it right from the start	28-9320-93
Brochures	
The Trap platform and Tecan automation—efficient solutions for screening proteins	28-9289-59
MultiTrap 96-well plates: Applications and guidelines	28-9511-27
Whatman syringe filter collection	28-9844-13
User manual	
Ettan DIGE System User Manual	18-1173-17
Data files and Application notes	
Available on the Web at www.gelifesciences.com	

Ordering information

	Quantity	Code number
Untagged protein enrichment		
NHS HP SpinTrap	5 ml bulk medium and 24 empty SpinTrap columns	28-9031-28
NHS Mag Sepharose	1 × 500 µl 4 × 500 µl	28-9440-09 28-9513-80
HiTrap NHS-activated HP	5 × 1 ml columns	17-0716-01
NHS HP SpinTrap Buffer Kit	1	28-9135-69
Streptavidin HP SpinTrap	16 × 100 µl columns	28-9031-30
Streptavidin HP SpinTrap Buffer Kit	1	28-9135-68
Streptavidin HP MultiTrap	4 × 96-well plates; 50 µl/well	28-9031-31
Protein A HP SpinTrap	16 × 100 µl columns	28-9031-32
Protein A HP MultiTrap	4 × 96-well plates; 50 µl/well	28-9031-33
Protein A Mag Sepharose	1 × 500 µl 4 × 500 µl	28-9440-06 28-9513-78
HiTrap Protein A HP	5 × 1 ml columns	17-0402-01
HiTrap rProtein A FF	5 × 1 ml columns	17-5079-01
Protein G HP SpinTrap	16 × 100 µl columns	28-9031-34
Protein A/G HP SpinTrap Buffer Kit	1	28-9135-67
Protein G HP MultiTrap	4 × 96-well plates; 50 µl/well	28-9031-35
Protein G Mag Sepharose	1 × 500 µl 4 × 500 µl	28-9440-08 28-9513-79
HiTrap Protein G HP	5 × 1 ml columns	17-0404-01
Ab SpinTrap	50 × 100 µl columns	28-4083-47
Immunoprecipitation Starter Pack	1	17-6002-35
TiO ₂ Mag Sepharose	1 × 500 µl 4 × 500 µl	28-9440-10 28-9513-77
MagRack 6	1	28-9489-64
MagRack Maxi	1	28-9864-41
Small-scale antibody purification		
Protein A HP SpinTrap	16 × 100 µl columns	28-9031-32
rProtein A GraviTrap	10 × 1 ml	28-9852-54
rProtein A/Protein G GraviTrap	10 × 1 ml	28-9852-56
Protein A HP MultiTrap	4 × 96-well plates; 50 µl/well	28-9031-33
Protein A Mag Sepharose Xtra	2 × 1 ml 5 × 1 ml	28-9670-56 28-9670-62
Protein G HP SpinTrap	16 × 100 µl columns	28-9031-34
Protein G GraviTrap	10 × 1 ml	28-9852-55
Protein G HP MultiTrap	4 × 96-well plates; 50 µl/well	28-9031-35
Protein G Mag Sepharose Xtra	2 × 1 ml 5 × 1 ml	28-9670-66 28-9670-70
HiTrap Protein A HP	1 × 1 ml 1 × 5 ml 2 × 1 ml 5 × 1 ml 5 × 5 ml	29-0485-76 17-0403-01 17-0403-03 17-0402-01 17-0403-03

	Quantity	Code number
HiTrap Protein G HP	1 × 1 ml	29-0485-81
	1 × 5 ml	17-0405-01
	2 × 1 ml	17-0404-03
	5 × 1 ml	17-0404-01
	5 × 5 ml	17-0405-03
HiTrap Protein L	1 × 1 ml	29-0486-65
	1 × 5 ml	17-5478-15
	5 × 1 ml	17-5478-51
	5 × 5 ml	17-5478-55
HiTrap IgM Purification HP	5 × 1 ml	17-5110-01
HiTrap IgY Purification HP	1 × 5 ml	17-5115-01
Ab SpinTrap	50 × 100 µl columns	28-4083-47
Ab Buffer Kit	1	28-9030-59

Desalting/buffer exchange/cleanup

Disposable PD-10 Desalting	30 × columns	17-0851-01
LabMate PD-10 Buffer Reservoir	10	18-3216-03
PD MidiTrap G-25	50 × columns	28-9180-08
PD MiniTrap G-25	50 × columns	28-9180-07
PD SpinTrap G-25	50 × columns	28-9180-04
PD MultiTrap G-25	4 × 96-well plates; 500 µl/well	28-9180-06
PD MidiTrap G-10	50 × columns	28-9180-11
PD MiniTrap G-10	50 × columns	28-9180-10
HiTrap Desalting	5 × 5 ml columns	17-1408-01
HiPrep 26/10 Desalting	1 × 53 ml column	17-5087-01
Mini Dialysis Kit – 1 kDa cut-off	1	80-6483-75
Mini Dialysis Kit – 1 kDa cut-off	1	80-6483-94
Mini Dialysis Kit – 8 kDa cut-off	1	80-6484-13
Mini Dialysis Kit – 8 kDa cut-off	1	80-6484-32
2-D Clean-Up Kit	1	80-6484-51
SDS-PAGE Clean-Up Kit	1	80-6484-70

Enzyme regulation

Protease Inhibitor Mix	1	80-6501-23
Nuclease Mix	1	80-6501-42

Fractionation

2-D Fractionation Kit	1	80-6501-04
2-D Quant Kit	1	80-6483-56
NanoVue Plus	1	28-9569-65

	Quantity	Code number
Histidine-tagged protein capture		
His GraviTrap	10 × columns	11-0033-99
His Mag Sepharose Ni	2 × 1 ml	28-9673-88
	5 × 1 ml	28-9673-90
	10 × 1 ml	28-9799-17
His GraviTrap Kit	1	28-4013-51
His MultiTrap HP	4 × 96-well plates; 50 µl/well	28-4009-89
His MultiTrap FF	4 × 96-well plates; 50 µl/well	28-4009-90
His SpinTrap	50 × columns	28-4013-53
His SpinTrap Kit	1	28-9321-71
His Buffer Kit	1	11-0034-00
Anti-His antibody	170 µl	27-4710-01
HisTrap HP	5 × 1 ml columns	17-5247-01
HisTrap FF	5 × 1 ml columns	17-5319-01
HisTrap FF crude	5 × 1 ml columns	11-0004-58
HisTrap FF crude Kit	1	28-4014-77
HisPrep FF 16/10	1 × 20 ml column	28-9365-51
His SpinTrap TALON	50 × 0.1 ml	29-0005-93
His GraviTrap TALON	10 × 1 ml	29-0005-94
His MultiTrap TALON	4 × 96-well plates	29-0005-96
HiTrap TALON crude	5 × 1 ml	28-9537-66
	100 × 1 ml	28-9538-05
	5 × 5 ml	28-9537-67
	100 × 5 ml	28-9538-09
TALON Superflow	10 ml	28-9574-99
	50 ml	28-9575-02
His Mag Sepharose excel	2 × 1 ml	17-3712-20
	5 × 1 ml	17-3712-21
	10 × 1 ml	17-3712-22
HisTrap excel	5 × 1 ml	17-3712-05
	5 × 5 ml	17-3712-06
Ni Sepharose excel	25 ml	17-3712-01
	100 ml	17-3712-02
	500 ml	17-3712-03
Membrane Protein Purification Kit	1	28-9805-82
Maltose Binding Protein (MBP)-tagged protein capture		
MBPTrap HP	5 × 1 ml columns	28-9187-78
Strep-tag II protein capture		
StrepTrap HP	5 × 1 ml columns	28-9075-46

	Quantity	Code number
GST-tagged protein capture		
GST Detection Module	50 detections	27-4590-01
GST 96-well Detection Module	5 plates	27-4592-01
GSTPrep FF 16/10	1 × 20 ml column	28-9365-50
GSTrap HP	5 × 1 ml columns	17-5281-01
GSTrap FF	5 × 1 ml columns	17-5130-01
GSTrap 4B	5 × 1 ml columns	28-4017-45
GST GraviTrap	10 × 1 ml columns	28-9523-60
GST MultiTrap FF	4 × 96-well plates; 50 µl/well	28-4055-01
GST MultiTrap 4B	4 × 96-well plates; 50 µl/well	28-4055-00
GST SpinTrap	50 × 50 µl columns	28-9523-59
GST Buffer Kit	1	28-9523-61
pGEX vectors	25 µl	multiple
GST Vector primers for sequencing	0.05 A ₂₆₀ unit	multiple
<i>E. coli</i> BL21	1 vial	27-1542-01
M13K07 Helper Phage	100 µl	27-1524-01
GST Bulk Kit	1	27-4570-01
PreScission Protease	500 units	27-0843-01
Thrombin	500 units	27-0846-01
Factor Xa	400 units	27-0849-01
Anti-GST Antibody	0.5 ml, 50 detections	27-4577-01
Protein depletion		
HiTrap Albumin & IgG Depletion	2 × 1 ml	28-9466-03
Albumin & IgG Depletion SpinTrap	10 × columns	28-9480-20
Lysis/protein extraction		
Sample Grinding Kit	50 samples	80-6483-37
Yeast Protein Extraction Buffer Kit	1	28-9440-45
Mammalian Protein Extraction Buffer	1 × 500 ml	28-9412-79
2-D Protein Extraction Buffer Trial Kit	6 × 10 ml	28-9435-22
2-D Protein Extraction Buffer-I	1 × 50 ml	28-9435-23
2-D Protein Extraction Buffer-II	1 × 50 ml	28-9435-24
2-D Protein Extraction Buffer-III	1 × 50 ml	28-9435-25
2-D Protein Extraction Buffer-IV	1 × 50 ml	28-9435-26
2-D Protein Extraction Buffer-V	1 × 50 ml	28-9435-27
2-D Protein Extraction Buffer-VI	1 × 50 ml	28-9435-28
illustra triplePrep Kit	1	28-9425-44

	Quantity	Code number
Protein concentration		
Vivaspin 500, 3 kDa MWCO PES	25	28-9322-18
Vivaspin 500, 5 kDa MWCO PES	25	28-9322-23
Vivaspin 500, 10 kDa MWCO PES	25	28-9322-25
Vivaspin 500, 30 kDa MWCO PES	25	28-9322-35
Vivaspin 500, 50 kDa MWCO PES	25	28-9322-36
Vivaspin 500, 100 kDa MWCO PES	25	28-9322-37
Vivaspin 2, 3 kDa MWCO PES	25	28-9322-40
Vivaspin 2, 5 kDa MWCO PES	25	28-9322-45
Vivaspin 2, 10 kDa MWCO PES	25	28-9322-47
Vivaspin 2, 30 kDa MWCO PES	25	28-9322-48
Vivaspin 2, 50 kDa MWCO PES	25	28-9322-57
Vivaspin 2, 100 kDa MWCO PES	25	28-9322-58
Vivaspin 6, 3 kDa MWCO PES	25	28-9322-93
Vivaspin 6, 5 kDa MWCO PES	25	28-9322-94
Vivaspin 6, 10 kDa MWCO PES	25	28-9322-96
Vivaspin 6, 30 kDa MWCO PES	25	28-9323-17
Vivaspin 6, 50 kDa MWCO PES	25	28-9323-18
Vivaspin 6, 100 kDa MWCO PES	25	28-9323-19
Vivaspin 20, 3 kDa MWCO PES	25	28-9323-58
Vivaspin 20, 5 kDa MWCO PES	25	28-9323-59
Vivaspin 20, 10 kDa MWCO PES	25	28-9323-60
Vivaspin 20, 30 kDa MWCO PES	25	28-9323-61
Vivaspin 20, 50 kDa MWCO PES	25	28-9323-62
Vivaspin 20, 100 kDa MWCO PES	25	28-9323-63
IEX columns		
Mini Q PC 3.2/3	1 × 0.24 ml column	17-0686-01
Mini Q 4.6/50 PE	1 × 0.8 ml column	17-5177-01
Mini S PC 3.2/3	1 × 0.24 ml column	17-0687-01
Mini S 4.6/50 PE	1 × 0.8 ml column	17-5178-01
Mono Q PC 1.6/5	1 × 0.10 ml column	17-0671-01
Mono Q 5/50 GL	1 × 1 ml column	17-5166-01
Mono Q 4.6/100 PE	1 × 1.7 ml column	17-5179-01
Mono Q 10/100 GL	1 × 8 ml column	17-5167-01
Mono Q HR 16/10	1 × 20 ml column	17-0506-01
Mono S PC 1.6/5	1 × 0.10 ml column	17-0672-01
Mono S 5/50 GL	1 × 1 ml column	17-5168-01
Mono S 4.6/100 PE	1 × 1.7 ml column	17-5180-01
Mono S 10/100 GL	1 × 8 ml column	17-5169-01
Mono S HR 16/10	1 × 20 ml column	17-0507-01
Mono P 5/50 GL	1 × 1 ml column	17-5170-01
Mono P 5/200 GL	1 × 4 ml column	17-5171-01

	Quantity	Code number
GF columns		
Superdex Peptide PC 3.2/30	1 × 2.4 ml column	17-1458-01
Superdex Peptide 10/300 GL	1 × 24 ml column	17-5176-01
Superdex 75 PC 3.2/30	1 × 2.4 ml column	17-0771-01
Superdex 75 5/150 GL	1 × 3 ml column	28-9205-04
Superdex 75 10/300 GL	1 × 24 ml column	17-5174-01
Superdex 200 PC 3.2/30	1 × 2.4 ml column	17-1089-01
Superdex 200 5/150 GL	1 × 3 ml column	28-9065-61
Superdex 200 10/300 GL	1 × 24 ml column	17-5175-01
Superose 6 PC 3.2/30	1 × 2.4 ml column	17-0673-01
Superose 6 10/300 GL	1 × 24 ml column	17-5172-01
Superose 12 PC 3.2/30	1 × 2.4 ml column	17-0674-01
Superose 12 10/300 GL	1 × 24 ml column	17-5173-01

RPC columns

SOURCE 15RPC ST 4.6/100	1 × 1.7 ml column	17-5068-01
RESOURCE RPC, 1 ml	1 × 1 ml column	17-1181-01
RESOURCE RPC, 3 ml	1 × 3 ml column	17-1182-01

Reagents

Iodoacetamide	25 g	RPN6302
Tris	500 g	17-1321-01
Urea	500 g	17-1319-01
PlusOne Formamide	250 ml	17-1320-01
Dithiothreitol	1 g	17-1318-01
PlusOne Glycerol, 85%	1 l	17-1325-01
Sodium Dodecyl Sulfate	100 g	17-1313-01
Triton X-100	500 ml	17-1315-01
CHAPS	1 g	17-1314-01
PlusOne Tween 20	500 ml	17-1316-01
Bromophenol Blue	10 g	17-1329-01

Whatman Klari-Flex Bottle-Top System

15 ml, 0.22 PES Klari-Flex Bottle-Top Filter, Sterile	24	6518-0152
50 ml, 0.22 PES Klari-Flex Bottle-Top Filter, Sterile	24	6518-0502
250 ml, 0.22 PES Klari-Flex Bottle-Top Filter, Sterile	12	6514-2502
500 ml, 0.22 PES Klari-Flex Bottle-Top Filter, Sterile	12	6514-5002
1000 ml, 0.22 PES Klari-Flex Bottle-Top Filter, Sterile	12	6514-1002
Klari-Flex Cradle ring	1	6517-0001
Klari-Flex Pedestal stand	1	6517-0002

	Quantity	Code number
Whatman syringe filters		
Puradisc 4 mm syringe filter, sterile 0.2 µm PVDF	50	6791-0402
Puradisc 13 mm syringe filter, sterile 0.2 µm PVDF	50	6791-1302
Puradisc FP 13 mm syringe filter, sterile 0.2 µm RC	50	10462945
Puradisc 25 mm syringe filter, sterile 0.2 µm PES	50	6780-2502
GD/X 25 mm Syringe filter, sterile, 0.2 µm PVDF	50	6900-2502
GD/X 25 mm Syringe filter, sterile, 0.2 µm PES	50	6896-2502

Whatman centrifuge filters—ultrafiltration

VectaSpin Micro (0.4 ml), Cellulose Acetate MWCO 12K	1	6834-1001
VectaSpin Micro (0.4 ml), Cellulose Acetate MWCO 20K	1	6834-2001
VectaSpin Micro (0.4 ml), Polysulfone MWCO 30K	1	6835-3001
VectaSpin Micro (0.4 ml), Polysulfone MWCO 100K	1	6835-1101
VectaSpin 3 (3 ml), Polysulfone MWCO 10K	1	6835-1005
VectaSpin 3 (3 ml), Polysulfone MWCO 30K	1	6835-3005

Whatman syringeless filters

Mini-UniPrep Syringeless Filter, 0.2 µm PVDF	100	UN203NPEAQU
Mini-UniPrep Syringeless Filter, 0.2 µm RC	100	UN203NPERC
Autovial 12, sterile 0.2 PVDF	40	AV125SAQU

Other pack sizes and columns are available. Visit www.gelifesciences.com/protein-purification and www.gelifesciences.com/sampleprep for additional options.

GE, imagination at work, and GE monogram are trademarks of General Electric Company. ÅKTA, Biacore, CyDye, DeCyder, ECL Plex, Ettan, ExcelGel, Ficoll, GraviTrap HiTrap, illustra, ImageQuant, Immobiline, Klari-Flex, MidiTrap, Mini Q, Mini S, MiniTrap, Mini-UniPrep, Mono P, Mono Q, Mono S, MultiTrap, Percoll, Pharmalyte, RESOURCE, SPARTAN, Sephadex, Sepharose, SOURCE, SpinTrap, Superdex, Superose, UNIFILTER, and Whatman are trademarks of GE Healthcare companies.

Coomassie is a trademark of Imperial Chemical Industries Limited. Strep-tag is a trademark of IBA GmbH. TALON is a trademark of Clontech Laboratories Inc. Superflow is a trademark of Sterogene Bioseparations Inc. Zorbax is a trademark of Agilent Technologies Inc. Cymal is a trademark of Affymetrix Inc. Triton is a trademark of Union Carbide Chemicals and Plastic Company Inc. Brij and Tween are trademarks of Uniqema Americas LLC. Dionex and PepMap are trademarks of Dionex. Zwittergent is a trademark of EMD Chemicals Inc. Nonidet is a trademark of Shell Chemical Co. Lubrol is a trademark of Imperial Chemical Industries PLC. Zymolyase is a trademark of Kirin Brewery Co. Ltd. Tecan, Freedom EVO, Te-VacS, and Magellan are trademarks of Tecan Group Limited. Gammanorm is a trademark of Octapharma AB. Kathon is a trademark of Dow Chemical Co.

2-D Fluorescence Difference Gel Electrophoresis: 2-D Fluorescence Difference Gel Electrophoresis (2-D DIGE) technology is covered by US patent numbers 6,043,025, 6,127,134 and 6,426,190 and equivalent patents and patent applications in other countries and exclusively licensed from Carnegie Mellon University. CyDye: this product or portions thereof is manufactured under an exclusive license from Carnegie Mellon University under US patent numbers 5,569,587, 5,627,027 and equivalent patents in other countries. The purchase of CyDye DIGE Fluors includes a limited license to use the CyDye DIGE Fluors for internal research and development, but not for any commercial purposes. A license to use the CyDye DIGE Fluors for commercial purposes is subject to a separate license agreement with GE Healthcare.

CyDye: This product or portions thereof is manufactured under an exclusive license from Carnegie Mellon University under US patent number 5,268,486 and equivalent patents in the US and other countries.

The purchase of CyDye products includes a limited license to use the CyDye products for internal research and development but not for any commercial purposes. A license to use the CyDye products for commercial purposes is subject to a separate license agreement with GE Healthcare. Commercial use shall include:

1. Sale, lease, license or other transfer of the material or any material derived or produced from it.
2. Sale, lease, license or other grant of rights to use this material or any material derived or produced from it.
3. Use of this material to perform services for a fee for third parties, including contract research and drug screening.

If you require a commercial license to use this material and do not have one, return this material unopened to GE Healthcare Bio-Sciences AB, Björkgatan 30, SE-751 84 Uppsala, Sweden and any money paid for the material will be refunded.

DeCyder: This release of DeCyder software is provided by GE Healthcare to the customer under a non-exclusive license and is subject to terms and conditions set out in the 2-D Differential Gel Electrophoresis Technology Access Agreement. Customer has no rights to copy or duplicate or amend the Software without the prior written approval of GE Healthcare.

Deep Purple Total Protein Stain: Deep Purple Total Protein Stain is exclusively licensed to GE Healthcare from Fluorotechnics Pty Ltd. Deep Purple Total Protein Stain may only be used for applications in life science research. Deep Purple is covered under a granted patent in New Zealand entitled "Fluorescent Compounds", patent number 522291 and equivalent patents and patent applications in other countries.

GST Gene Fusion Vectors: A license for commercial use of GST Gene Fusion Vectors under US patent 5,654,176 and equivalent patents and patent applications in other countries must be obtained from Millipore Corp (formerly Chemicon International Inc).

IMAC Sepharose products, Ni Sepharose products, and Fe Sepharose products: These products are covered by US patent number 6 623 655 and equivalent patents and patent applications in other countries.

IMAC Sepharose products and Ni Sepharose products (Histidine-tagged protein purification) Purification and preparation of fusion proteins and affinity peptides comprising at least two adjacent histidine residues may require a license under US patent numbers 5,284,933 and 5,310,663, and equivalent patents and patent applications in other countries (assignee: Hoffman La Roche, Inc).

StrepTrap HP and StrepTactin Sepharose High Performance: These products are covered by US patent number 6,103,493 and equivalent patents and patent applications in other countries. The purchase of StrepTrap HP and StrepTactin Sepharose High Performance includes a license under such patents for non-profit and in-house research only. Please contact IBA (info@iba-go.com) for further information on licenses for commercial use of Strep-Tactin.

© 2010–2014 General Electric Company—All rights reserved.
First published Dec. 2010.

All goods and services are sold subject to the terms and conditions of sale of the company within GE Healthcare which supplies them. A copy of these terms and conditions is available on request. Contact your local GE Healthcare representative for the most current information.

GE Healthcare UK Limited Amersham Place
Little Chalfont
Buckinghamshire, HP7 9NA
UK

GE Healthcare Europe, GmbH
Munzinger Strasse 5
D-79111 Freiburg
Germany

GE Healthcare Bio-Sciences Corp.
800 Centennial Avenue, P.O. Box 1327
Piscataway, NJ 08855-1327
USA

GE Healthcare Japan Corporation
Sanken Bldg., 3-25-1, Hyakunincho
Shinjuku-ku, Tokyo 169-0073
Japan

For local office contact information,
please visit www.gelifesciences.com/contact

www.gelifesciences.com/sampleprep

GE Healthcare Bio-Sciences AB
Björkgatan 30
751 84 Uppsala
Sweden



imagination at work