

VACUUM OVENS 220 – 240 Volts



Installation - Operation Manual

SVAC1-2 SVAC2-2 SVAC4-2

Pictured on cover left to right: SVAC1-2, SVAC2-2, SVAC4-2

The oven requires either a NEMA 6-15P electrical power outlet or a Euro CEE 7/7 socket to plug into.

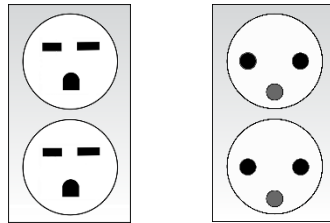

Benchtop Vacuum Ovens 220 - 240 Voltage

Part Number (Manual): 4861768

Revision: October 27, 2017



SHEL LAB is a brand of Sheldon Manufacturing, INC.

Safety Certifications

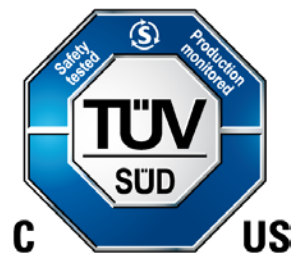

These units are CUE listed by TÜV SÜD as vacuum ovens for professional, industrial or educational use where the preparation or testing of materials is done at an ambient air pressure range of 22.14 – 31.3 inHg (75 – 106 kPa), and no flammable, volatile or combustible materials are being heated.

These units have been tested to the following requirements:

CAN/CSA C22.2 No. 61010-1:2012
CAN/CSA C22.2 No. 61010-2-010/R:2009
UL 61010-1:2012
UL 61010A-2-010:2002
EN 61010-1:2010
EN 61010-2-010:2003

TABLE OF CONTENTS

INTRODUCTION	7
<i>Read this Manual.....</i>	7
<i>Safety Considerations and Requirements</i>	7
<i>Contacting Assistance</i>	8
<i>Engineering Improvements.....</i>	8
<i>Temperature Reference Sensor Device</i>	8
<i>Vacuum Supply Required</i>	9
<i>Gaskets</i>	10
RECEIVING YOUR UNIT	11
<i>Inspect the Shipment.....</i>	11
<i>Orientation Photos.....</i>	12
<i>Record Data Plate Information.....</i>	16
INSTALLATION	17
<i>Installation Procedure Checklist</i>	17
<i>Required Ambient Conditions.....</i>	18
<i>Required Clearances.....</i>	18
<i>Environmental Disruption Sources.....</i>	18
<i>Power Source Requirements</i>	19
<i>Lifting and Handling</i>	19
<i>Leveling.....</i>	20
<i>Install the Oven.....</i>	20
<i>Installation Cleaning.....</i>	20
<i>Shelving Installation.....</i>	21
<i>Connect to the Vacuum Supply</i>	22
GRAPHIC SYMBOLS	23
CONTROL OVERVIEW	25
OPERATION.....	27
<i>Operating Precautions.....</i>	27
<i>Theory of Operation</i>	28
<i>Put the Oven into Operation</i>	30
<i>Put the Chamber Under Vacuum</i>	32
<i>Set the Constant Temperature Set Point</i>	33
<i>Heating Profiles</i>	33
<i>Set the Over Temperature Limit.....</i>	34
<i>Vacuum Gauge Operations</i>	36
<i>Maximum Obtainable Vacuum.....</i>	37
<i>Pressure Units Conversion Chart.....</i>	37
<i>Data Port.....</i>	38
USER MAINTENANCE.....	39
<i>Cleaning and Disinfecting.....</i>	39
<i>Maintaining Atmospheric Integrity</i>	40
<i>Electrical Components</i>	40
<i>Vacuum Pump Maintenance.....</i>	40
<i>Storage.....</i>	40
<i>Calibrate the Temperature display.....</i>	41
<i>Diagnostics - Heating Issues.....</i>	45
UNIT SPECIFICATIONS	53
<i>Weight.....</i>	53
<i>Dimensions.....</i>	53
<i>Capacity</i>	54
<i>Vacuum</i>	54
<i>Temperature.....</i>	54
<i>Power.....</i>	54

REPLACEMENT PARTS LIST..... 55
Replacement Gaskets..... 56

TABLE OF CONTENTS

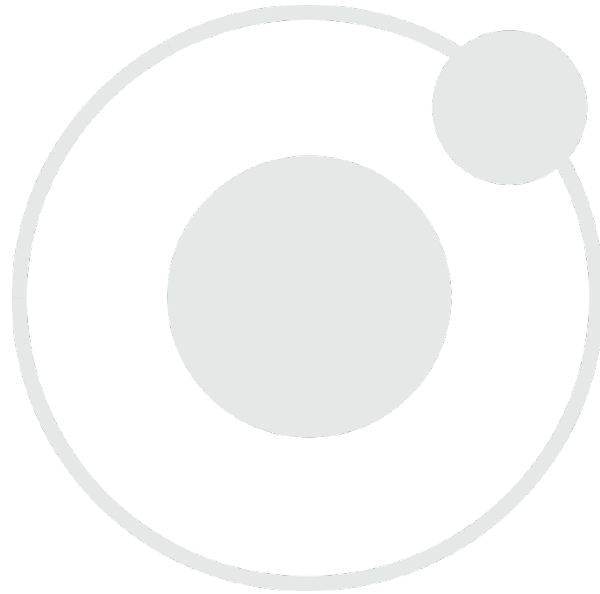

INTRODUCTION

Thank you for purchasing a SHEL LAB oven. We know you have many choices in today's competitive marketplace when it comes to constant temperature equipment. We appreciate you choosing ours. We stand behind our products and will be here if you need us.

READ THIS MANUAL

Failure to follow the guidelines and instructions in this user manual may create a protection impairment by disabling or interfering with the unit safety features. This can result in injury or death.

Before using the unit, read the manual in its entirety to understand how to install, operate, and maintain the unit in a safe manner. Keep this manual available for use by all operators. Ensure all operators are given appropriate training before the unit begins service.

SAFETY CONSIDERATIONS AND REQUIREMENTS

Follow basic safety precautions, including all national laws, regulations, and local ordinances in your area regarding the use of this unit. If you have any questions about local requirements, please contact the appropriate agencies.

SOPs

Because of the range of potential applications this unit can be used for, the operator or their supervisors must draw up a site-specific standard operating procedure (SOP) covering each application and associated safety guidelines. This SOP must be written and available to all operators in a language they understand.

Intended Applications and Locations

SVAC ovens are engineered for constant temperature drying, curing, and baking applications under vacuum in professional, industrial, and educational environments. The ovens are not intended for use at hazardous or household locations.

Power

Your unit and its recommended accessories are designed and tested to meet strict safety requirements.

- The unit is designed to connect to a power source using the specific power cord type shipped with the unit.
- Always plug the unit power cord into a protective earth grounded electrical outlet conforming to national and local electrical codes. If the unit is not grounded properly, parts such as knobs and controls can conduct electricity and cause serious injury.
- Do not bend the power cord excessively, step on it, or place heavy objects on it.
- A damaged cord can be a shock or fire hazard. Never use a power cord if it is damaged or altered in any way.
- Use only approved accessories. Do not modify system components. Any alterations or modifications to your oven can be dangerous and void your warranty.

INTRODUCTION

CONTACTING ASSISTANCE

Phone hours for Sheldon Technical Support are 6 am – 4:30 pm Pacific Coast Time (west coast of the United States, UTC -8). Please have the following information ready when calling or emailing Technical Support: the **model number** and the **serial number** (see page 16).

EMAIL: tech@shellab.com

PHONE: 1-800-322-4897 extension 4, or (503) 640-3000

FAX: (503) 640-1366

Sheldon Manufacturing, INC.

P.O. Box 627

Cornelius, OR 97113

ENGINEERING IMPROVEMENTS

Sheldon Manufacturing continually improves all of its products. As a result, engineering changes and improvements are made from time to time. Therefore, some changes, modifications, and improvements may not be covered in this manual. If your unit's operating characteristics or appearance differs from those described in this manual, please contact your SHEL LAB dealer or customer service representative for assistance.

TEMPERATURE REFERENCE SENSOR DEVICE

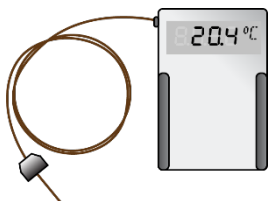

A temperature reference sensor for performing accuracy verifications or calibrations of the oven temperature display **must be purchased separately from the oven**. The reference device must be accurate to at least 1°C. Use a digital device with potted (sealed) thermocouple probes that can be inserted through and seal a KF-25 vacuum flange. Select probes suitable for the application temperature you will be verifying and calibrating the display at.

Alcohol thermometers are insufficient for conducting accurate temperature verifications and calibrations. Do not use a mercury thermometer. **Never place alcohol or mercury thermometers in the oven chamber.** Always use thermocouple probes.

INTRODUCTION

VACUUM SUPPLY REQUIRED

The oven does not come with a vacuum pump. **A pump must be separately purchased for the oven.**

Consult a vacuum pump specialist to determine the pump type best suited to your baking application. The correct selection of a vacuum pump is critical for evacuating the chamber to the level required for your vacuum baking applications in a timely manner. The nature of the sample or product being heated should drive the selection of the pump, including the types of chemicals outgassed during the baking process. Common pump types include Chemical Duty PTFE Dry, Standard Duty Dry, Compact Direct-Drive, and specialty pumps for Corrosive gasses. Selection of an application-specific pump can improve the overall oven performance and minimize pump maintenance costs.

Use of an oil trap plumbed on the vacuum line between the oven and the pump is strongly recommended. The trap protects the pump from any oils outgassed during your baking procedure. This extends the life of the pump. All maintenance and instructional information should be obtained from the pump manufacturer if it not shipped with the pump. Use of clamps to secure vacuum tubing is also recommended.

Minimum Vacuum Draw

To seal completely, the oven chamber must be under a minimum vacuum draw of:

inHg	mmHg	kPa	bar
-3.0	-76	-10	-0.1016

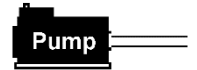

Or



INTRODUCTION

GASKETS

Gaskets are high-wear items, subject to compression forces, heat, and outgassed byproducts. Keeping a spare gasket on hand during operations is strongly recommended.

Each oven comes with a replaceable silicon gasket installed on the chamber liner. This gasket seals against the chamber door to maintain the vacuum integrity of the chamber. The gasket must be replaced periodically and is rated to 230°C. It is resistant to acids but not solvents. The manufacturer also offers for sale *Viton*®, fluorosilicone, and Buna gaskets. See page 56 for information on gasket type suitability for baking applications.

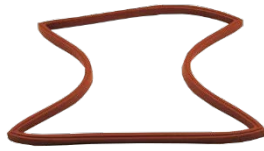

RECEIVING YOUR UNIT

INSPECT THE SHIPMENT

- When a unit leaves the factory, safe delivery becomes the responsibility of the carrier.
- **Damage sustained during transit is not covered by the manufacturing defect warranty.**
- Save the shipping carton until you are certain that the unit and its accessories function properly

When you receive your unit, inspect it for concealed loss or damage to its interior and exterior. If you find any damage to the unit, **follow the carrier's procedure for claiming damage or loss.**

1. Carefully inspect the shipping carton for damage.
2. Report any damage to the carrier service that delivered the unit.
3. If the carton is not damaged, open the carton and remove the contents.
4. The unit should come with an end-user Installation and Operation Manual and a programming guide for the Watlow EZ-Zone Controller.
5. Verify that the correct number of accessories have been included.
6. Carefully check all packaging for loose accessories before discarding.

Included Accessories:

SVAC1-2	Tall Shelves	Short Bottom Shelf	Power Cords*
	2	1	2

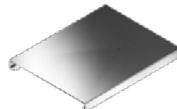
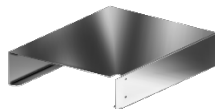

SVAC2-2	Tall Shelves	Short Bottom Shelf	Power Cords*	Leveling Feet
	2	1	2	4

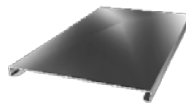
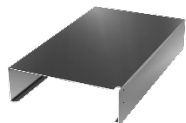

SVAC4-2	Shelves	Shelf Clips	Power Cords*	Leveling Feet
	3	12	2	4

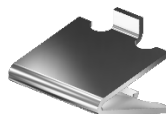
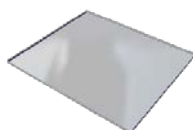

*1 Euro CEE 7/7 and 1 NEMA 6-15P power cord

RECEIVING YOUR UNIT

ORIENTATION PHOTOS

Figure 1: SVAC4-2

Back of Unit: Vacuum Port, Vent Port, Data Ports (See Page 9)



RECEIVING YOUR UNIT

Figure 2: SVAC2-2

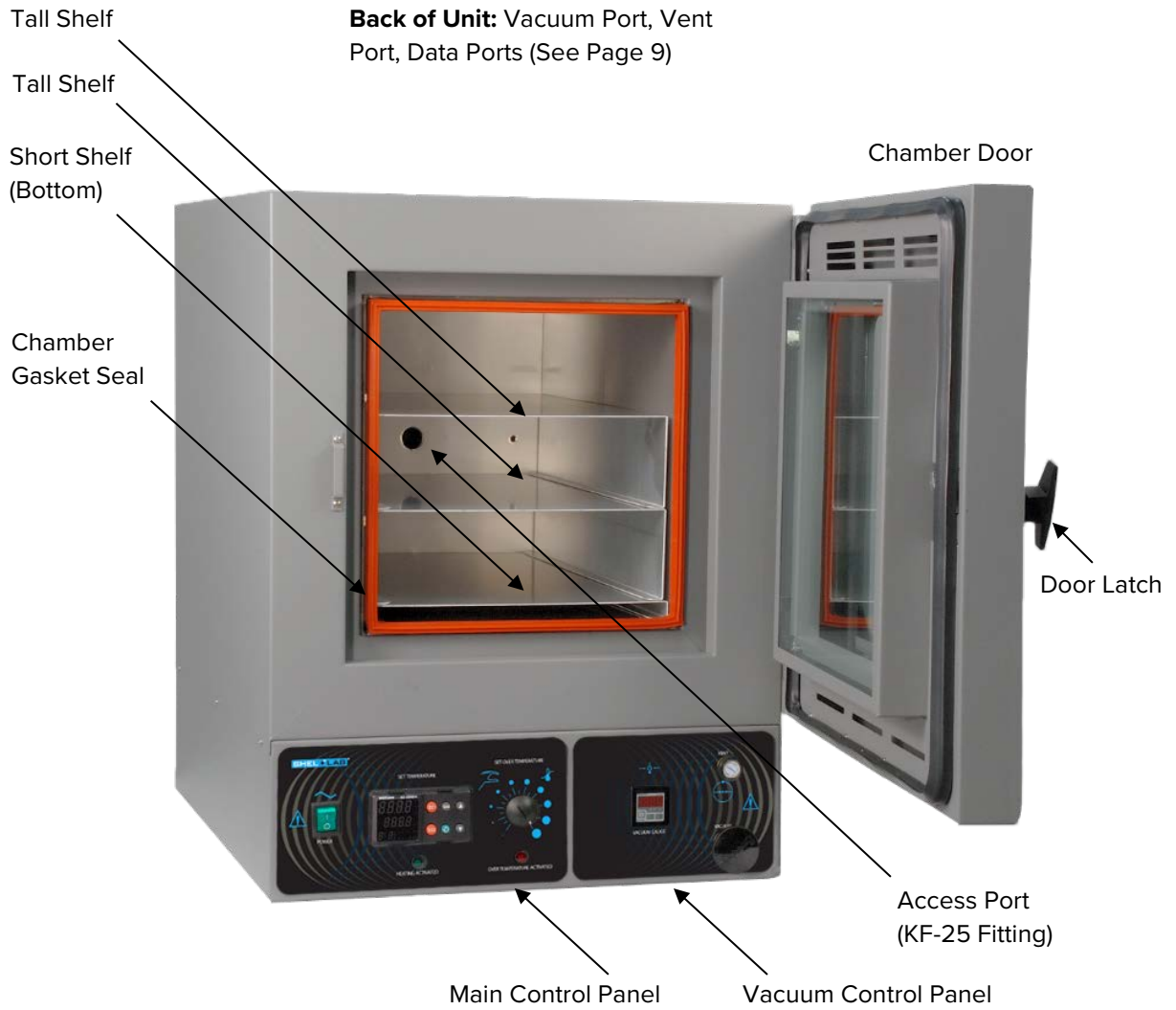

RECEIVING YOUR UNIT

Figure 4: SVAC1-2

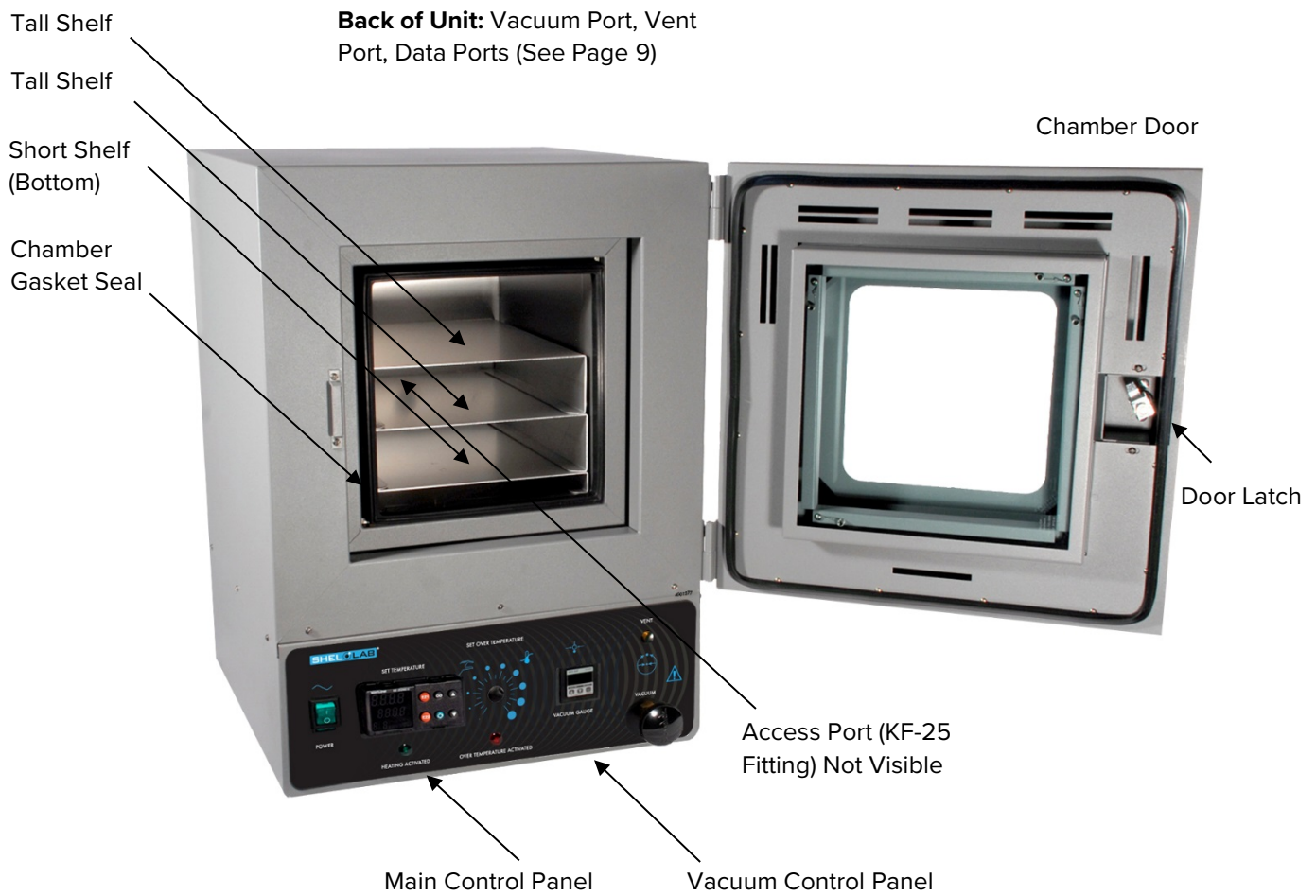

RECEIVING YOUR UNIT

Figure 5: Back of Ovens

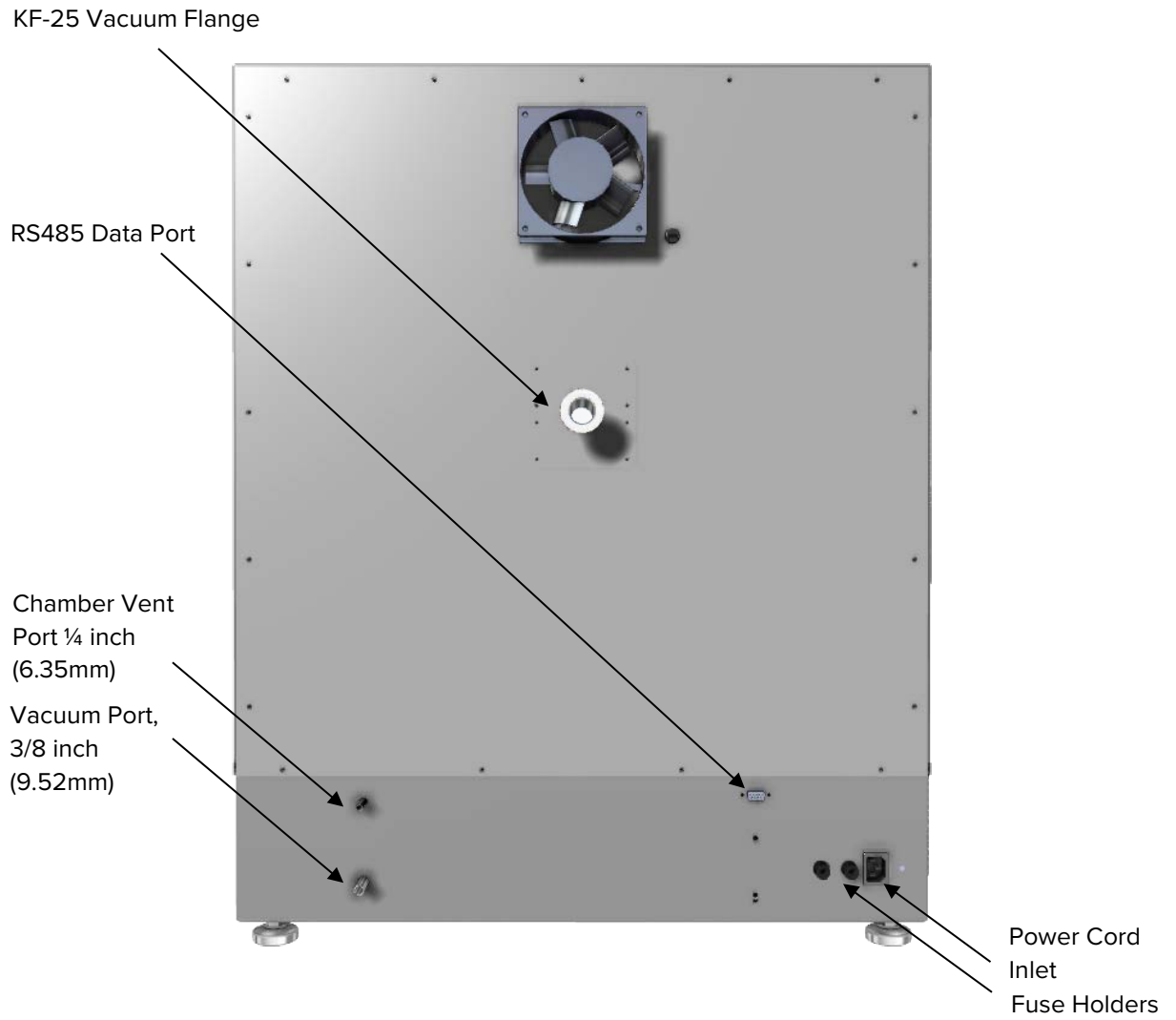

RECEIVING YOUR UNIT

RECORD DATA PLATE INFORMATION

Locate the data plate on the back of the oven, just above the power cord inlet. The data plate contains the oven model number and serial number. Enter this information below for future reference.

Data Plate Information

Model Number	
Serial Number	

INSTALLATION PROCEDURE CHECKLIST

Carry out the procedures and steps listed below to install the oven in a new workspace location and prepare it for use. All procedures are found in the Installation section of this manual.

Pre-Installation

- ✓ Verify that a vacuum supply source (stand-alone pump or in-house system) suitable for your application is available and can be connected to the oven. See page 22 for the oven gas and vacuum port locations.
- ✓ Check that the required ambient condition for the unit are met, page 18
- ✓ Check that the spacing clearance requirements are met, page 18
 - Unit dimensions may be found on page 41.
- ✓ Check for performance-disrupting heat and cold sources in the environment, page 18.
- ✓ Check that a suitable electrical outlet and power supply is present, page 19.

Installing the Oven in a suitable workspace location

- ✓ Review the lifting and handling instructions, page 19.
- ✓ Install the oven in its workspace location, page 20.
- ✓ Make sure the oven is level, page 20.

Set up the Oven for use

- ✓ Clean the oven shelving. Clean the chamber if needed, page 20.
- ✓ Install the shelving in the oven chamber, page 21.
- ✓ Connect the oven to its vacuum supply source, page 22.
- ✓ **Optional:** Connect the oven to a neutral backfill gas supply. See page 22.

INSTALLATION

REQUIRED AMBIENT CONDITIONS

This oven is intended for use indoors, at room temperatures between **15°C and 40°C (59°F and 104°F)**, at no greater than **80% Relative Humidity** (at 25°C / 77°F).

Operating these units outside of these conditions may adversely affect temperature stability and effective operating range. For conditions outside of those listed above, please contact your SHEL LAB distributor to explore other options suited to your laboratory or production environment.

REQUIRED CLEARANCES

These clearances are required to provide air flows for ventilation and cooling.

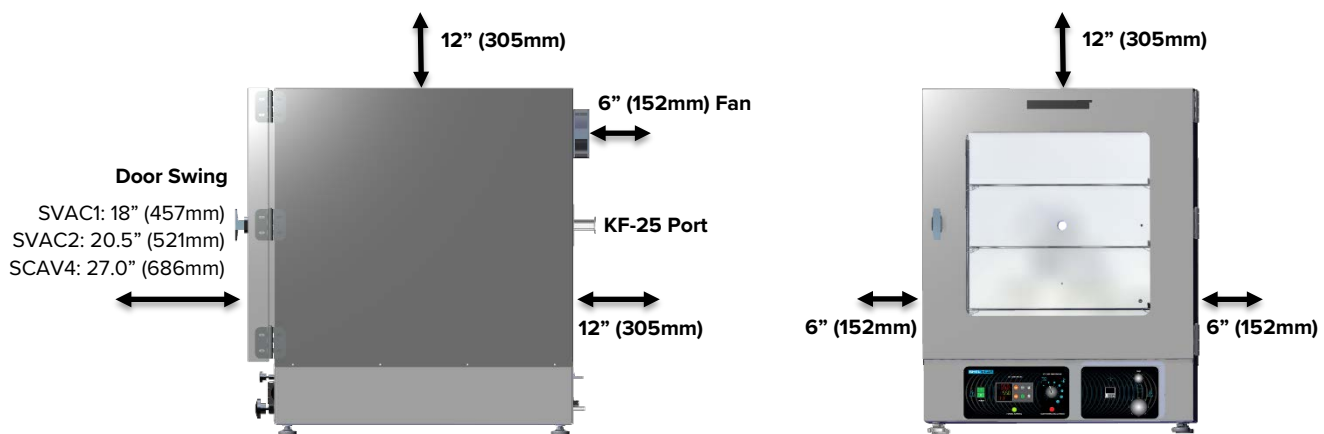

4 inches (102mm) of clearance is required on the sides and back.

2 inches (51mm) of headspace clearance between the top of the unit and any overhead partitions.

Do not place objects on top of the oven.

A KF-25 vacuum port is located on the back of the oven for introducing potted (sealed) probes into the chamber or connecting to an external vacuum supply source. Leave sufficient clearance for operators to safely access this port.

ENVIRONMENTAL DISRUPTION SOURCES

When selecting a location to install the unit, consider all environmental conditions that can adversely impact its temperature performance. These include:

- Proximity to other ovens, autoclaves, and any device that produces significant radiant heat
- Heating and cooling vents or other sources of fast-moving air currents
- High-traffic areas
- Direct sunlight

INSTALLATION

POWER SOURCE REQUIREMENTS

When selecting a location for the unit, verify each of the following requirements is satisfied:

Power Source: The wall power outlet must meet the power requirements listed on the unit data plate.

Model	AC Voltage	Amperage	Frequency
SVAC1-2	220 - 240	4.5	50/60 Hz
SVAC2-2	220 - 240	5.5	50/60 Hz
SVAC4-2	220 - 240	7.0	50/60 Hz

- Wall power sources must be protective earth grounded and **single phase**.
- Wall power sources must conform to all national and local electrical codes.
- **Supplied voltage must not vary more than 10% from the data plate rating.** Damage to the unit may result if the supplied voltage varies more than 10%.
- **The recommended wall circuit breakers for these units are 16 amps.**
- Use a separate circuit to prevent loss of product due to overloading or circuit failure. The circuit must match or exceed the amperage requirement listed on the unit the data plate.

Power Cord: The unit must be positioned so that all end-users can quickly unplug the oven in the event of an emergency.

- The unit comes provided with 250Volt, 10Amp, 8ft 2in (2.5m), CEE 7/7 power cord.
- The unit comes provided with a 240 volt, 15Amp, 8ft 2in (2.5m) NEMA 6-15P power cord.

Fuses: These units ship with two 16 amp 250V 5x20mm fuses installed in fuse holders immediately adjacent to the power cord inlet.

- Both fuses must be installed and intact for the unit to operate.
- Always find and fix the cause of a blown fuse prior to putting the unit back into operation.

LIFTING AND HANDLING

The oven is heavy. Use appropriate lifting devices that are sufficiently rated for these loads. Follow these guidelines when lifting the oven:

- Lift the oven only from its bottom surface.
- Doors, handles, and knobs are not adequate for lifting or stabilization.
- Restrain the oven completely while lifting or transporting so it cannot tip.
- Remove all moving parts, such as shelves and trays, and lock doors in the closed position during transfers to prevent shifting and damage.

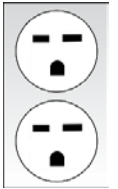
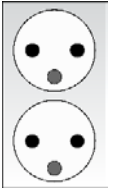

INSTALLATION

LEVELING

The unit must be level and stable for safe operation.

Install the 4 leveling feet with the 4 corner holes on the bottom of the oven.

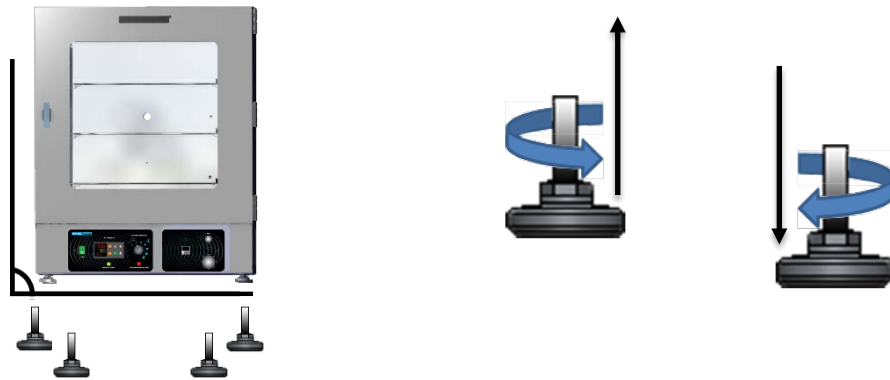

Note: To prevent damage when moving the unit, turn all four leveling feet so that the leg of each foot sits inside the unit.

INSTALL THE OVEN

Install the unit in a workspace location that meets the criteria discussed in the previous entries of the Installation section.

- Do not connect the oven to its power source at this time.

INSTALLATION CLEANING

The manufacturer recommends cleaning the shelving and oven chamber prior to installation of the shelving in the chamber. The unit was cleaned at the factory but may have been exposed to contaminants during shipping. Remove all wrappings and coverings from shelving prior to cleaning and installation. **Do not clean with deionized water.**

See the [Cleaning and Disinfecting](#) topic in the User Maintenance section (see page 39) for more information on how to clean the oven chamber and shelving.

INSTALLATION

SHELVING INSTALLATION

Heating in a vacuum environment takes place primarily through conduction. Heat is transported from the heating elements to the samples or product through the shelves. Perform the following steps to install the shelves so that heat conducts properly.

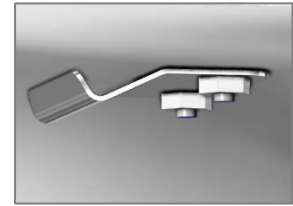

Temperature Probe Shelf Clip, SVAC1 and SVAC2

SVAC1-2 and SVAC2-2

These ovens are provided with three stacking shelves. The short shelf goes on the bottom of the stack.



SVAC1 and SVAC2 Shelving Configuration

1. Carefully slide the short shelf into position on the chamber floor.
 - a. Slide the clip located on the bottom of the short shelf onto the oven temperature probe. The oven probe extends from the back wall near the floor of the chamber.
 - The short shelf must be on the bottom of the shelf-stack to ensure the oven meets its temperature uniformity specifications.
2. Place the 2 tall shelves on top of the short shelf.

SVAC4-2

To ensure accurate temperature measurement, **one shelf bottom must be in close proximity to the oven temperature probe** extending out from the back wall. Do not place the shelf in contact with the probe.

3. Install 4 shelf clips per shelf in the slots of the shelf standard mounting rails located on the sides of the chamber interior.
 - a. Squeeze each clip, insert the top tab first, and then the bottom tab using a rocking motion.
4. Set a shelf on each set of 4 clips. Make sure the shelves are level.



Installing SVAC4 Shelf Clip



Rocking Motion

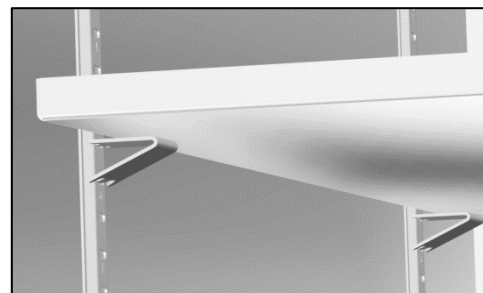

Shelf set on Clips

INSTALLATION

CONNECT TO THE VACUUM SUPPLY

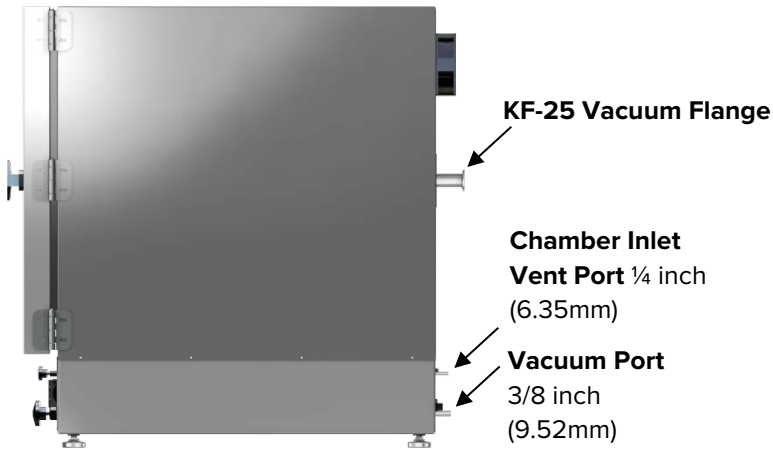

Figure 6: Vacuum and Vent inlet ports

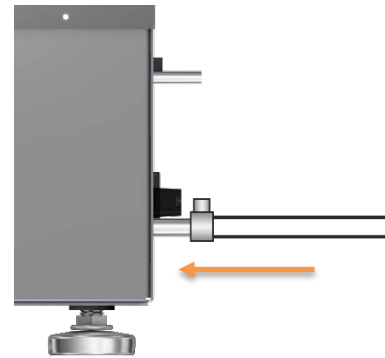





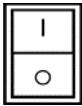





Figure 7: Vacuum Line Connected to Vacuum Port

Use of clamps to secure tubing to the Vacuum Port and Chamber Intake Vent is recommended.

- **The Vacuum Port – 3/8 Inch (9.52mm) OD**
 - Connect a vacuum supply capable of supplying up to -29 inches of mercury (inHg) of vacuum to this port. Chamber atmosphere is evacuated through this port.
 - This port is opened and closed by the Vacuum Valve control on the front control panel.
- **The Chamber Vent Port (Inlet) – 1/4 Inch (6.35mm) OD**
 - This intake port allows external atmosphere to backfill the oven chamber when the chamber Vent Valve control on the front control panel is set to open.
 - Optional: An inert backfill gas supply source may be connected to this port. **The maximum allowed pressure for a backfilling gas is 15 psi.**
- **KF-25 Fitting**
 - This large fitting is normally used to introduce potted (sealed) sensor probes into the oven chamber for temperature display verifications and calibrations. Probes must be inserted and secured prior to placing the chamber under vacuum.
 - A vacuum supply can be connected to the KF-25 flange for increased efficiency in vacuuming down the chamber. However, the Vacuum Valve control on the front control panel will not affect the level of vacuum and must be set to closed to prevent atmosphere from entering the chamber through the Vacuum Port.

GRAPHIC SYMBOLS

The oven is provided with multiple graphic symbols on its interior and exterior surfaces. The symbols identify hazards and the functions of the adjustable components, as well as important notes in the user manual.

Symbol	Definition
	Consult the user manual. Consulter le manuel d'utilisation
	Over Temperature Limit system Thermostat température limite contrôle haute
	AC Power Repère le courant alternatif
	I/ON O/OFF I indique que l'interrupteur est en position marche. O indique que le commutateur est en position d'arrêt.
	Manually adjustable Indique un réglage manuel
	Potential shock hazard Risque de choc électrique
	Recycle the unit. Do not dispose of in a landfill. Recycle l'unité. Ne jetez pas dans une décharge
	Protective earth ground Terre électrique
	Indicates: Caution hot surface Indique: Avertissement symbole de surface chaude

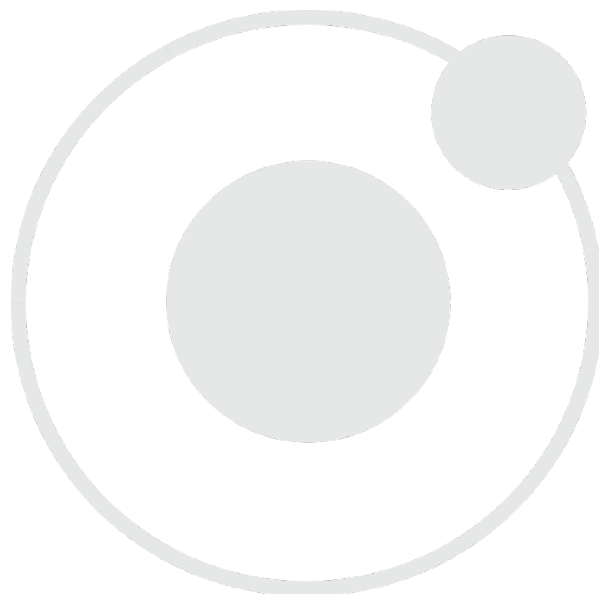

CONTROL OVERVIEW

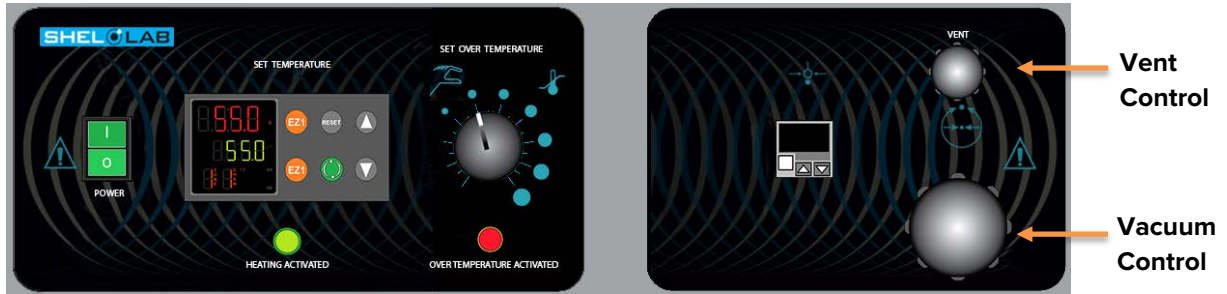

Figure 8: SVAC2-2 and SVAC4-2 Control Panel

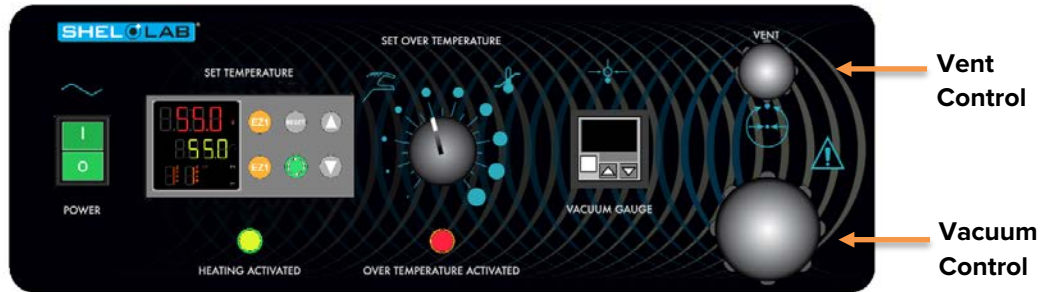

Figure 9: SVAC1-2 Control Panel

Power Switch

The self-illuminating main power switch controls all power the oven and its systems. The switch must be in the (I) on position for the unit to function.



Temperature Controller - Display on Home Page



Top Line (Red): Current chamber shelving temperature

Middle Line (Green): The constant temperature set point

Bottom Line: Flashing "1" indicates the controller is calling for heat

While on the Home Page, the **Up** and **Down arrow** buttons adjust the constant temperature set point. Pressing and holding both buttons jumps from the Home Page to menu pages. On the menu pages, the buttons adjust calibrations offsets and heating profile variables.

The green **Advance** button scrolls forward through menus and parameters lists when programming heating profiles or performing a temperature calibration.

The gray **Reset** button scrolls the display back to the previous page or menu. Pressing the Reset button repeatedly returns the display to the home page. On older ovens, the Reset button may be labeled with an infinity ∞ symbol rather than RESET.

The Orange **EZ1** button launches and aborts Heating Profile 1. The EZ2 button has no function.



CONTROL OVERVIEW

Heating Activated Light



This indicator lamp illuminates whenever the oven is powering its heating elements. The lamp often lags behind the flashing 1 on the controller display. This delay is a normal part of the heating process and accounted for in the PID tuning.

Over Temperature Limit Control (OTL)



This graduated dial sets the heating cutoff limit for the Over Temperature Limit system. The OTL is an independent mechanical heating cutoff that helps protect samples against unchecked heating. For more details, please see the explanation of the [Over Temperature Limit System](#) on page 29 in the Theory of Operation entry.

OTL Light



Marked OVER TEMPERATURE ACTIVATED, this light illuminates while the OTL System is routing power away from the heating elements to prevent heating in the oven chamber. Under normal operating conditions this light should not illuminate.

Vacuum Gauge



This digital gauge shows the chamber vacuum level relative to the room atmospheric pressure. The gauge activates automatically when the Main Power switch is in the On (I) position.

In its factory setting, the gauge shows the chamber pressure in inches of mercury (inHg), with a display range of 0 to -29.9inHg. 0 is the room atmosphere pressure and -29.9inHg a near-perfect vacuum, relative at sea level. See page 36 for how to set the gauge to show other units of measurement.

Vacuum Control Valve

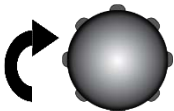

Close

This valve adjusts the level of vacuum draw applied to the oven chamber through the 3/8in Vacuum Port on the back of the oven.

- When **open**, this valve allows a connected, active vacuum supply to evacuate the oven chamber.
- In the **closed** position, the valve closes off the vacuum draw.

Vent Control Valve

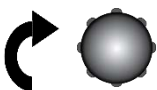

Close

This valve controls the oven chamber inlet Vent Port on the back of the oven.

- In the **open** position, the oven chamber is open to external atmosphere through the Vent Port.
 - Optional: A neutral or clean backfilling gas supply connected to the Vent Port will flow gas from the pressurized supply to the oven chamber when the Vent Valve is open.
- When the valve control is in the **closed** position, the chamber is cut off from external atmosphere and any backfill gas supply.
 - **The vent must be closed before evacuating the chamber.** Failure to do so may result in damage to the vacuum pump.

Safe operation of the oven is dependent on the actions and behavior of the oven operators.

Operating personnel must read and understand the Operating Precautions in this section prior to operating the oven. The operators must follow these instructions to prevent injuries and to safeguard their health, environment, and the materials being treated in the oven, as well as to prevent damage to the oven. Failure to adhere to the Operating Precautions, deliberately or through error, is a hazardous behavior on the part of the operator.



Le fonctionnement sûr du four dépend des actions et du comportement des opérateurs du four. Le personnel d'exploitation doit lire et comprendre les consignes de sécurité et les précautions d'utilisation de cette section avant d'utiliser le four. Les opérateurs doivent suivre ces instructions pour prévenir les blessures et protéger leur santé, leur environnement et les matériaux traités dans le four, ainsi que pour éviter d'endommager le four. Le non-respect des consignes de sécurité et des précautions d'utilisation, délibérément ou par erreur, est un comportement dangereux de la part de l'opérateur.



OPERATING PRECAUTIONS

- Do not use this oven in unsafe improper applications that produce flammable or combustible gasses, vapors, liquids, or fuel-air mixtures in quantities that can become potentially explosive.
- Outgassed byproducts may be hazardous to or noxious for operating personnel. Vacuum pump exhaust should be vented to a location outside the workspace in a safe manner in accordance with all applicable laws, ordinances, and regulations. Do not operate the oven in an unsafe area with noxious fumes.
- Do not use this oven for applications heating hazardous fibers or dust. These items can become airborne and come into contact with hot surfaces.
- Individual ovens are not rated to be explosion proof. Follow all building certification requirements and laws for Class I, II, or III locations as defined by the US National Electric Code.
- The bottom surface of the chamber should not be used as a work surface. It runs hotter than the shelf temperatures. Never place samples or product on the oven chamber floor.
- Do not place sealed or filled containers in the oven. These may burst open when the chamber is under vacuum.
- Do not place alcohol or mercury thermometers in the oven. With improper use, they can rupture.
- Do not move the oven until it has finished cooling.

Warning Hot Surfaces: These areas are marked with Hot Surface labels. Proper protective equipment should be employed to minimize the risk of burns.

Avertissement Surface Chaude: Ces zones sont marquées avec des étiquettes de surface chaude. Un équipement de protection approprié devrait être utilisé pour minimiser le risque de brûlures.



THEORY OF OPERATION

The SVAC ovens are intended for use in closed-cycle, under-vacuum applications.

Vacuum

The oven chamber is evacuated by a vacuum pump or building system. The vacuum supply is connected to the Vacuum Port on the back of the oven. The current level of relative vacuum is displayed on the Vacuum Gauge on the main control panel.

The oven chamber is pressure rated to -29.91inHg gauge pressure at near sea level. Vacuum levels obtained in the oven chamber are dependent on pump performance, valve settings, and the nature of the application or process, including the volume of material outgassed. The maximum attainable vacuum is governed by altitude above sea level (see page 37 for more information).

The chamber must be sealed off from the room atmosphere prior to the start of a vacuum baking application. The oven is not built to operate with the chamber exposed to free atmosphere or to circulate air within the chamber. Running the oven with the door or the vent open may risks destroying the vacuum pump and damaging the integrity of the oven chamber.

Vacuum pumps and door gaskets should be selected on the basis of the application or process. Some gaskets are vulnerable to different chemicals, and vacuum pumps vary in suitability and safety depending on the outgassed byproduct types and moisture level produced in the oven chamber.

Gas Backfill

A gas supply can be connected to the vent intake port located on the back of the oven. Nitrogen or a neutral gas may be used to backfill an evacuated oven chamber in order to avoid particulate contamination or oxidation. The maximum allowed backfill pressure is 15 psi of delivery at the oven vent port.

Heating Options

The oven can either heat to and run at a constant temperature set point or execute a programmable multistep heating profile with ramp up, heat soak, and ramp down intervals.

Heating in a Vacuum

In normal ovens, a powered element transfers heat into the chamber air. The heated air then circulates by natural convection or blower fan action, and surrounds the product on the shelves, gradually bringing it to temperature. In a vacuum oven, there is no atmosphere to transport heat evenly from the elements to the product. Instead, heat transport takes place primarily by conduction. The oven heating elements are located in side ducts and heat the chamber walls, which in turn transfer heat to the shelves. Each shelf then transports heat to the products or samples resting on it.

Direct radiant heating through infrared emission in a vacuum environment provides poor temperature uniformity compared to conductive heating.

The oven internal microprocessor stores a user-selected temperature set point. When powered, the oven heats the chamber shelves to the currently programmed temperature set point. The microprocessor board is wired to a solid-state temperature probe located in the chamber on the rear wall. When the processor detects the temperature of the shelf in close proximity to the probe dropping below the temperature set point, it pulses power to the heating elements.

The processor employs proportional-integral-derivative analytical feedback-loop functions when measuring and controlling the shelving temperature. PID-controlled heating pulse intensities and lengths are proportional to the difference between the measured shelf temperature and the current set point. The frequency of pulses is derived from the rate of change in that difference. The integral function slows the rate of pulses when the temperature nears the set point to avoid overshooting.

SVAC ovens rely on natural heat radiation for cooling. The oven can achieve a low-end operating temperature of the ambient room temperature plus 10°C.

Allowing the oven to heat up with atmosphere in the chamber can result in a significant heat spike when the chamber is brought under vacuum.

The Over Temperature Limit System (OTL)

When set, the mechanical OTL heating cutoff system prevents runaway heating in the oven chamber. The OTL cutoff operates independently of the microprocessor main controller and is provided with a separate, hydrostatic temperature sensor probe located in the oven chamber. In the event the chamber shelving temperature exceeds the current OTL setting, the OTL routes power away from the heating elements. The OTL will continue to prevent heating until the temperature drops below its limit setting. **The Over Temperature Limit is set by the end-user**, typically at approximately 5°C above the application constant temperature set point or the highest set point of a multi-step heating profile application.

OPERATION



PUT THE OVEN INTO OPERATION

Verify all the required procedures in the Installation section have been carried out. Then perform the following steps and procedures to prepare the oven for use in a new location.

1 Attach the Power Cord



Attach the cord that came with the unit to the power inlet receptacle on the back of the oven.

2



Plug the cord into the workspace electrical supply.

3 Plug in the Vacuum Pump



Plug the vacuum pump power cord into a wall power source.

4 Verify the Valves are Closed

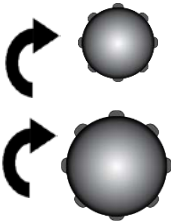

Check that oven **chamber door is closed and latched**, and that the **vent** (inlet) and **vacuum** valves are both in **the closed position**.

Always verify that the oven chamber is sealed prior to starting the oven to help safeguard your vacuum pump from prolonged exposure to streaming atmosphere.

5 Turn on the Oven

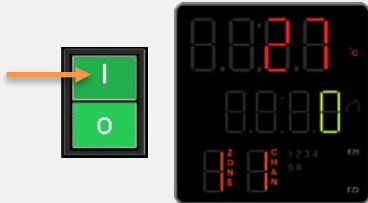

Place the oven **Power Switch** in the on (I) position.

- The controller display will illuminate and default to its home page.
- The vacuum display will illuminate.

6 Verify OTL Control Set to Maximum

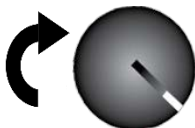

This prevents the OTL system from interfering with the setup process.

Continued next page

OPERATION

Continued from the previous page

7 Verify Vacuum Integrity

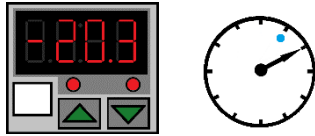

10 Minutes Minimum

Place the Chamber Under Vacuum for 10 minutes to verify the integrity of the vacuum supply system. **See page 32**

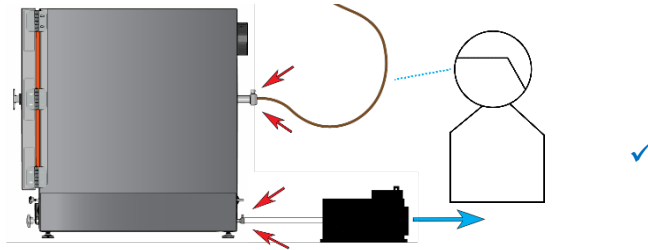

8 Set the Operating Temperature



Set the Oven Temperature to your baking application constant temperature or profile warm up temperature while the chamber is under vacuum. See page 33.

Note: The oven chamber should always be under vacuum when heating the chamber to the set point.

9

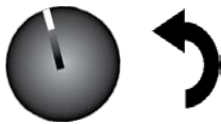

Set the Over Temperature Limit. See page 34

The oven must be heated and under vacuum to perform this procedure.

The oven is now ready for use

OPERATION

PUT THE CHAMBER UNDER VACUUM



Put the oven chamber under vacuum for at least 10 minutes when first putting the oven into operation in a new location to verify the integrity of the vacuum supply system. The oven chamber requires at least -3inHg (-76mmHg or -10kPa) of vacuum draw in order to seal.

Vacuum Down the Oven Chamber



Turn the Vent Valve inlet control to the closed position (all the way clockwise)

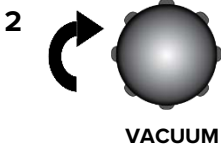

Turn the Vacuum Valve control to the closed position (all the way clockwise), if it is not already closed. **Note:** Always make sure the Vacuum and Vent valves are closed prior to applying vacuum to the chamber. This protects the vacuum supply system from damage.

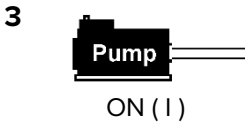

Turn on the vacuum source so that it supplies vacuum to the oven.

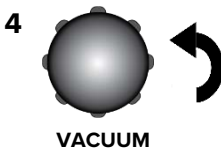
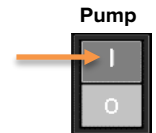

Open the oven Vacuum Valve by turning it all the way counterclockwise to bring oven chamber under vacuum draw. The Vacuum Gauge on the front panel should show a negative number counting down.

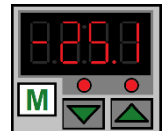

Holding At Vacuum



Keep the oven chamber under vacuum throughout the duration of your baking application to help evacuate outgassed byproducts.

The achievable vacuum level is dependent on altitude above sea level as well as the vacuum supply efficiency and volume of outgassed byproducts.

Restore Atmosphere to the Oven Chamber

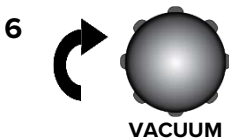

Turn the Vacuum Valve control back to the closed position (clockwise) to protect the vacuum pump from exposure to streaming atmosphere.

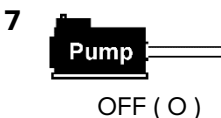

Turn off the pump.



Slowly turn the Vent Valve control to the Open position to backfill the oven chamber with atmosphere or gas.

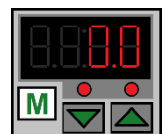

End of procedure

OPERATION

Note: When putting the oven into operation in a new location, set the constant temperature set point equal to your application or the highest temperature of your multi-step heating profile.

Note: An active profile overrides the constant temperature set point. The constant temperature set point cannot be adjusted while a heating profile is active.

SET THE CONSTANT TEMPERATURE SET POINT



1. Adjust the constant temperature set point on the home page



Adjust



Note: Holding down an arrow button will cause the temperature to advance in increments of ten (10).

2. Release the Arrow buttons after adjusting the Set Point



Oven Heating

- There may be a brief pause as the oven controller calculates the optimum power usage to achieve the set point starting from the current oven chamber temperature.
- A small illuminated 1 near the bottom of the display indicates the temperature controller is calling for heat.

HEATING PROFILES

Please see the *Programming Guide – Watlow EZ-Zone Controller Heating Profiles* document for instructions on how to program automated heating recipe profiles. The guide comes included with the oven and provides illustrated explanations for all major heating profile functions and programming.



**Home Page:
Profile Active
Indicator**



**EZ1 Button Launches and
Aborts Profile 1**

OPERATION

Note: Test the OTL heating cutoff system at least once per year for functionality.



SET THE OVER TEMPERATURE LIMIT

The oven chamber must be under vacuum, operating at your highest application temperature, and must be stable for **at least 30 minutes** prior to setting the OTL.

1. Set OTL control to its maximum setting, if not already set to max.

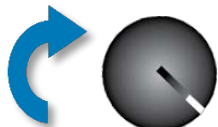

2. Turn the dial counterclockwise until the red Over Temperature Limit Light illuminates.



3. Slowly turn the dial clockwise until the OTL Activated light turns off.



4. Leave the OTL dial set just above the activation point.



- The Over Temperature Limit is now set approximately 5°C above the current oven shelving temperature.

Optional: Turn the dial slightly to the left.



- This sets the OTL cutoff threshold nearer to the current shelving temperature.

If the OTL is sporadically activating, you may turn the dial slightly to the right (clockwise).

If the OTL continues activating, check for ambient sources of heat or cold that may be adversely impacting the unit temperature stability. Check if any powered accessories in the workspace chamber are generating heat. If you can find no sources of external or internal temperature fluctuations, contact Tech Support or your distributor for assistance.

End of Procedure

OTL Activation During Normal Operations

Possible causes:

- A user has set the Over Temperature Limit below either the current set point for an active heating profile or below the constant-temperature set point.
- An external heat source or a heat source inside the chamber is causing the chamber temperature to spike.
- The temperature controller or its sensor probe have failed and must be replaced in order to resume safe operation of the oven.

If the OTL activated during normal operations, adjust the control dial clockwise halfway to the next dot to increase the setting. If the OTL continues to interrupt heating of the oven chamber and there no obvious external sources of nearby heating (autoclaves, another oven), depower the oven and allow the oven chamber to cool before opening the oven door or troubleshooting.

End of procedure

OPERATION

VACUUM GAUGE OPERATIONS

Change the Unit of Measurement

1. Place the vacuum gauge in its adjustment mode.



- a. Press and hold the “M” button for approximately 3 seconds
- b. The display will begin to blink and show a unit of measurement

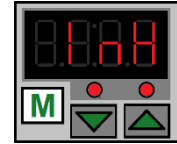

Inches of Mercury



2. Use the arrow keys to scroll between units.

3. Exit the adjustment mode.



- a. Press and hold the “M” button for approximately 3 seconds
- b. The display will cease blinking and show the current chamber pressure.

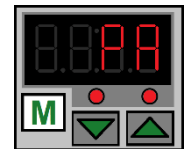

Kilopascals

Units of Measurement – Display Characters

kPa	Kgf/cm ²	bar	psi	mmHg	inHg	mmH ₂ O
00.00	0.000	0.000	0.000	0.000	0.000	0.000

Zero Out the Gauge

As set at the factory, the vacuum gauge shows a reading of 0 inches of mercury (inHg) when the chamber is at ambient (room) pressure. The display was set at near sea level.

If the gauge does not show 0inHg when the chamber is at room atmospheric pressure, perform the following step.

1. With the chamber door **open**, press and hold both the Up and Down arrow buttons.
 - a. Release the buttons when the display shows 0.0.

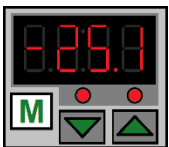

Both



See page 54 for the zero equivalent for units of measurement other than inHg.

OPERATION

MAXIMUM OBTAINABLE VACUUM

The maximum vacuum obtainable is a set by the altitude of the oven workspace or laboratory environment. The atmosphere is less dense at higher altitudes than at sea level. While a vacuum pump will evacuate the same percentage of atmosphere from the oven chamber, less overall pressure is expelled because of the reduced density.

Altitude (Feet)	Altitude (Meters)	Atmospheric Pressure	Maximum Vacuum Level Attainable*
Sea Level	Sea Level	14.70 psi	-29.9 inHg
1000ft	305m	14.16 psi	-28.9 inHg
2000ft	610m	13.66 psi	-27.8 inHg
3000ft	914m	13.16 psi	-26.8 inHg
4000ft	1219m	12.68 psi	-25.8 inHg
5000ft	1524m	12.22 psi	-24.9 inHg
6000ft	1829m	11.77 psi	-24.0 inHg
7000ft	2134m	11.33 psi	-23.1 inHg
8000ft	2438m	10.91 psi	-22.2 inHg
9000ft	2743m	10.50 psi	-21.4 inHg
10,000ft	3048m	10.10 psi	-20.6 inHg

*In gauge pressure

PRESSURE UNITS CONVERSION CHART

	InHg	kPa	Kgf/cm ²	bar	psi	mmHG	mmH ₂ O
1 inHg	1	3.3863	0.0345	0.3386	0.4911	25.400	345.32
1 kPa	0.2953	1	0.0102	0.01	0.1450	7.5006	101.97
1 Kgf/cm ²	28.9590	98.0665	1	0.9806	14.2233	735.55	10000.27
1 bar	29.5300	100	1.0197	1	14.5037	750.06	10197.44
1 psi	2.0360	6.8947	0.0703	0.0689	1	51.7150	703.09
1 mmHG	0.0394	1.3332	0.0014	0.0013	0.0193	1	13.5954
1 mmH ₂ O	0.0028	0.0098	0.0001	0.0001	0.0014	0.0029	1

DATA PORT



The 9-pin RS485 data port, located on the back of the oven, connects to the oven temperature controller. It is primarily intended for updating the controller software but can be used for data logging and graphical profile programming.

Software

- **National Instrument LabView** and **Watlow Specview** — Allows temperature monitoring and data logging in graphical user interface environments.
- **Watlow's EZ Zone™ Configurator** — Used to program heating profiles in a drop-down menu environment. Configurator can also be used to copy and save the controller configuration file, which includes the currently programmed heating profiles.
 - Configurator is available for free on the Watlow website.

USER MAINTENANCE

Warning: Prior to maintenance or cleaning of this unit, disconnect the power cord from the power supply.

Avertissement: Avant d'effectuer toute maintenance ou entretien de cet appareil, débrancher le cordon secteur de la source d'alimentation.



CLEANING AND DISINFECTING

If a hazardous material or substance has spilled in the unit, immediately initiate your site Hazardous Material Spill Containment protocol. Contact your local Site Safety Officer and follow instructions per the site policy and procedures.

- Periodic cleaning is required.
- Do not use spray on cleaners or disinfectants. These can leak through openings and coat electrical components.
- Do not use cleaners or disinfectants that contain solvents capable of harming paint coatings or stainless steel surfaces. **Do not use chlorine-based bleaches or abrasives; these will damage the chamber liner.**
- Consult with the manufacturer or their agent if you have any doubts about the compatibility of decontamination or cleaning agents with the parts of the equipment or with material contained in it.

Warning: Exercise caution if cleaning the unit with alcohol or flammable cleaners. Always allow the unit to cool down to room temperature prior to cleaning and make sure all cleaning agents have evaporated or otherwise been completely removed prior to putting the unit back into service.

Avertissement: Soyez prudent lorsque vous nettoyez l'appareil avec de l'alcool ou des produits de nettoyage inflammables. Laissez toujours refroidir l'appareil à la température ambiante avant le nettoyage et assurez-vous que tous les produits de nettoyage se sont évaporés ou ont été complètement enlevés avant de remettre l'appareil en service.



Cleaning

1. Remove all removable chamber accessories items (shelves, racks, and any additional items), if present.
2. Clean the chamber interior with a mild soap and water solution, including all corners.
3. Take special care when cleaning around the temperature sensor probes. Do not clean the probes.
4. Clean all removable accessories and components.
5. Rinse the chamber surfaces and shelving with distilled water and wipe dry with a soft cloth. Do not use deionized water.
 - Deionized water is an aggressive solvent that will attack most metals. Never use deionized water to clean your oven, even if it is readily available in your laboratory or production workspace.

USER MAINTENANCE

Disinfecting

Disinfect the oven if algae, mold, bacteria, or other biological contaminants are an issue. For maximum effectiveness, disinfection procedures are typically performed after cleaning. Keep the following points in mind:

- Turn off and unplug the unit to safeguard against electrical hazards.
- Disinfect the oven chamber using commercially available disinfectants that are non-corrosive, non-abrasive, and suitable for use on stainless steel and glass surfaces. Contact your local Site Safety Officer for detailed information on which disinfectants are compatible with your applications.
- If permitted by your protocol, remove all interior accessories (any shelving and other non-attached items) from the chamber when disinfecting.
- Disinfect all surfaces in the chamber, making sure to thoroughly disinfect the corners. Exercise care to avoid damaging the sensor probes.
- When disinfecting external surfaces, use disinfectants that will not damage painted metal, glass, and plastic.

MAINTAINING ATMOSPHERIC INTEGRITY

Periodically, inspect the door latch, trim, catch, and gasket for signs of deterioration. Failure to maintain the integrity of the door system shortens the lifespan of the unit.

ELECTRICAL COMPONENTS

Electrical components do not require maintenance. If the oven fails to operate as specified, please contact your distributor or [Sheldon Technical Support](#) for assistance.

VACUUM PUMP MAINTENANCE

Refer to the operation manual supplied with your vacuum pump for recommended maintenance routine, such as oil levels, replacement of sorbent charge, and exhaust filter change outs. **Contact your vacuum pump supplier if you do not have an operation manual.**

STORAGE

To prepare the unit for storage, remove all shelves, dry the chamber completely, and disconnect the power supply. Be certain that the door is positively locked in the closed position.

USER MAINTENANCE

CALIBRATE THE TEMPERATURE DISPLAY

Note: Performing a temperature display calibration requires a temperature reference device. Please see the [Reference Sensor Devices entry](#) on page 8 for device requirements.

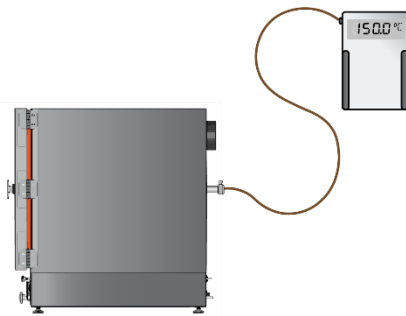

Temperature calibrations match the temperature display to the actual shelving temperature in the oven chamber. The actual shelving temperature is supplied by a reference sensor device. Calibrations compensate for drifts in the controller as well as those caused by the natural material evolution of the sensor probe in the heated oven chamber. Calibrate as often as required by your laboratory or production protocol, or regulatory compliance schedule. Always calibrate using industry or field standards.

The manufacturer recommends calibrating at the constant set point temperature of your application or at the median of your multi-step set heating profile.

Suggested Temperature Calibration Set Up

1



Introduce potted (sealed) thermocouple probes from a reference device into the oven chamber through the KF-25 port on the back of the oven

- Place at least 12 inches (305mm) of thermocouple wire in the chamber to prevent heat sinking outside temperatures.

2

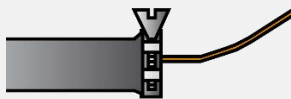

Use the KF-25 clamp included with the oven to secure the potted probes and seal the flange.

3

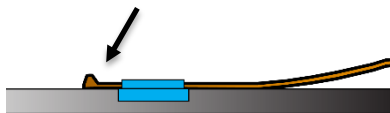

The thermocouple probe ends must be in direct contact with the shelving. The probes may be taped to the shelves using heat-resistant non-stick tape. Use the tape to secure any loose wiring.

If using only a single thermocouple, place the probe on the shelving as close as possible to the geometric center of the chamber.

4

VACUUM GAUGE



Evacuate the chamber to the vacuum level of your application or baking process. The chamber must be under vacuum in order to perform an accurate temperature calibration.

Continued next page

USER MAINTENANCE

- 5 **Stability:** The oven temperature must be stable in order to perform an accurate calibration. The temperature is considered stabilized when the oven chamber has operated under vacuum at your calibration temperature for at least 1 hour with no fluctuations of 1°C or greater.

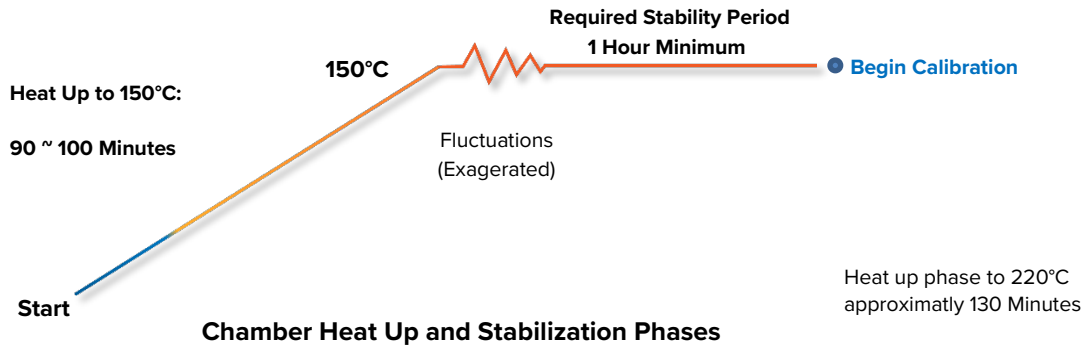

Suggested Temperature Calibration

1. Once the chamber has stabilized, compare the reference temperature device and chamber temperature display readings.
 - a. If the readings are the same, or the difference between the two (2) falls within the acceptable range of your protocol, the display is accurately showing the chamber temperature. **The Temperature Calibration procedure is now complete.**
- OR-
- b. See step 2 if a difference falls outside the acceptable range of your protocol.

Reference Device



2. The display requires calibration.
 - The difference between the reference device and the display is an **offset**.
 - Examples of offset values:

Reference Sensor Reading	Oven Temp Display	Offset Value
152.0°C	150°C	2
148.2°C	150°C	-2

Reference Device



- a. **Note the offset value for use in Step 5.**

USER MAINTENANCE

Temperature Calibration (Continued)

3. Open the temperature controller Operations Selection Menu.



- Press and hold both the **Up** and **Down** Arrow buttons simultaneously for approximately 3 seconds.
- Release the buttons when "A1" appears in the Upper Display and "Oper" appears in the Lower Display.



Operations Selection Menu

4. Advance through the Operations menu to the Temperature Calibration page.



- Push the green **Advance button** repeatedly until "i.CA" appears in the green middle display and a number value in the red top display.



Calibration Offset

5. Adjust the number value in the top display to match the offset value, using the arrow buttons.



6. Save the calibration offset and return to the Home Page.



- Push the **Reset Button** repeatedly until the display shows the home page.
- The oven will begin to heat or passively cool to reach the current set point with the offset display value.



Home Page

7. Allow the oven to stabilize after achieving the temperature set point using the offset display value.



Continued next page

USER MAINTENANCE

Temperature Calibration (Continued)

8. Once the chamber has stabilized for a half hour, compare the reference temperature device and oven temperature display readings.

- a. If the readings are the same, or the difference between the two (2) falls within the acceptable range of your protocol, the display is now accurately showing the chamber temperature. **The Temperature Calibration procedure is complete.**

-OR-

- b. See step 9 if a difference falls outside the acceptable range of your protocol again.



9. Repeat steps 2 – 8, up to two more times.

- Three calibration attempts may be required to successfully calibrate ovens that are more than $\pm 2^{\circ}\text{C}$ out of calibration.
- a. See the next step if the second two calibration attempts fail.



10. If the temperature readings difference still falls outside your protocol after three calibration attempts, contact your distributor or Technical Support for assistance.

End of procedure

USER MAINTENANCE

DIAGNOSTICS - HEATING ISSUES

If the unit is experiencing heating issues, use the following guide to gather information on the unit, prior to contacting Technical Support. Gathering and sharing this information with Tech Support significantly increases the chance a service technician will be dispatched with the parts needed to fix your unit during the first visit.

Steps

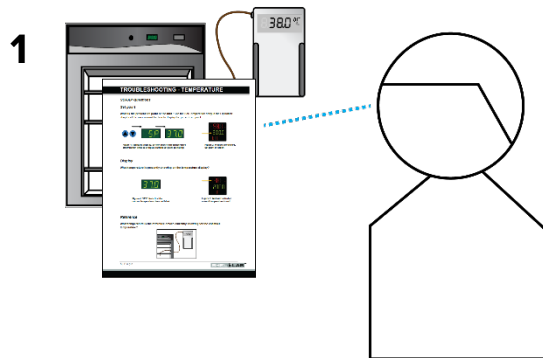

Read the SDRAP diagnostic questions on pages 50 and 51 and observe the unit in operation.

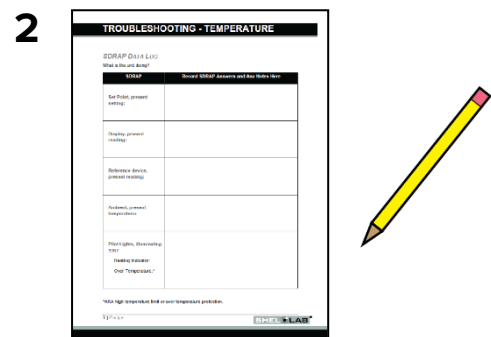

Record the observations in the SDRAP Data Log on page 46.

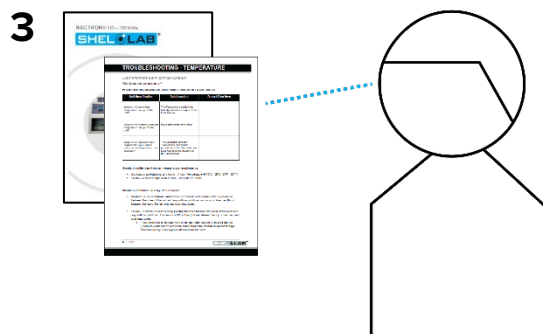

Read the Unit Performance Specification questions on page 47 and consult the user manual for

answers.
Share this information with Tech Support!

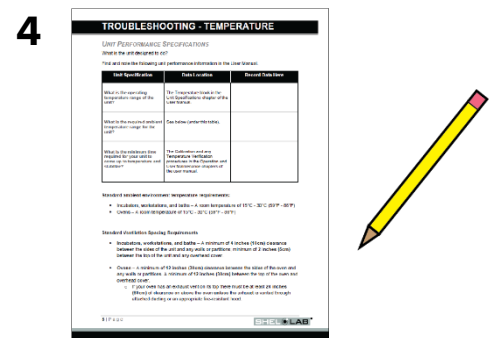

Record the answers in the Unit Specifications Log on page 47.

5

USER MAINTENANCE

SDRAP Data Log

What is the unit doing? See pages 50 - 51 for the detailed walkthrough of the SDRAP questions.

SDRAP	Record SDRAP Answers and Any Notes Here
S et Point, present setting:	
D isplay, present Temperature reading:	
R eference device, present reading:	
A mbient, present temperature:	
P ilot Lights, illuminating Y/N?	Heating Indicator:
	Over Temperature Activated:

This page may be copied for institutional use

USER MAINTENANCE

Unit Performance Specifications

What is the unit designed to do?

Find and note the following unit designation and performance information in the user manual.

Unit Specification	Data Location	Record Data Here
Model Type:	This manual covers SVAC4-2s, SVAC2-2s, and SVAC1-2s. See the Orientation Photos on pages 12 through 14 or the data plate on the unit to identify your model type.	
What is the operating temperature range of the unit?	The Temperature block in the Unit Specifications chapter, page 54.	
What is the required ambient temperature range for the unit?	See below (under this table).	
What is the minimum time required for your unit to come up to temperature and stabilize?	Allow 100 minutes for the unit to achieve 150°C or 130 minutes to achieve 220°C.	

Standard ambient environment temperature requirements:

- A room temperature of 15°C - 30°C (59°F - 86°F)

Standard Ventilation Spacing Requirements

- A minimum of **6 inches (152mm)** clearance between the sides of the oven and any walls or partitions.
- A minimum of **12 inches (305mm)** between the top of the oven and overhead cover.
- At least **12 inches (305mm)** between the back of the oven and any partitions or objects.

This page may be copied for institutional use

USER MAINTENANCE

Required Items

You must have the following items on hand to answer the diagnostic questions.

A temperature reference device – A calibrated digital thermometer with a potted sensor probe. The device must be at least as accurate as the temperature display of your unit.

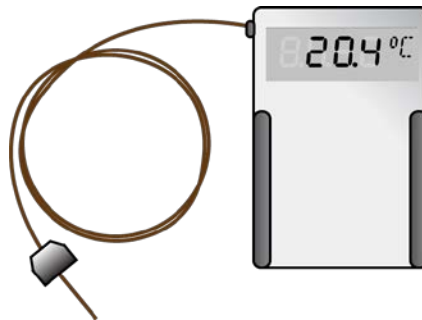

A copy of the user manual for the unit – Must be available in the same room as the unit for use.



USER MAINTENANCE

Note: Does the car actually have gas in the tank? Have you physically verified the computer is plugged in? Yes, we are going to ask some very basic questions. Please bear with. Methodical verifications and the elimination of assumptions are often the quickest means of getting a unit back into operation.

Before Starting

1. The unit must be connected to a power source that meets the requirements in the Installation chapter (page 19) and turned on.

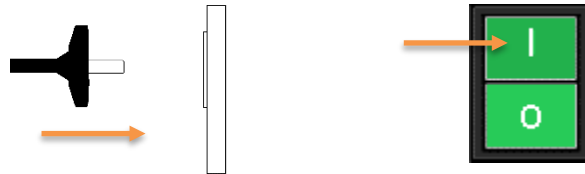

2. A reference temperature device sensor probe must be placed in the chamber.
 - See the probe placement instructions in the [Temperature Calibration procedure](#) on page 41

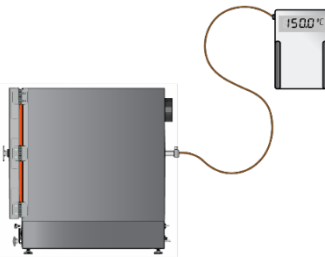

3. The oven chamber must be sealed and be under vacuum. See the [Place the Chamber Under Vacuum](#) entry on page 32.

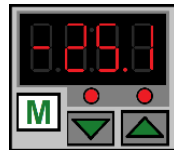

4. The unit must have adequate time to come up to temperature and stabilize. **Failure to wait will result in an inaccurate diagnosis.**



- Allow 100 minutes for the unit to achieve 150°C or 130 minutes to achieve 220°C.
- Start the “Diagnostic Data Procedure” **when the allotted time has passed**, even if the unit fails to achieve the set point temperature.

USER MAINTENANCE

Diagnostic Data Procedure – SDRAP Questions

Set point?

What is the present set point of the unit? See the Set Temperature entry in the “Operation” chapter of the user manual for how to display the present set point.

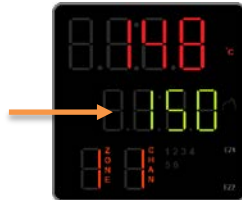

Figure 10: Set Point in Green

Display?

What chamber temperature is presently showing on the temperature display?



Figure 11: Present temperature in red

Reference?

What temperature is the reference device currently showing for the chamber temperature?

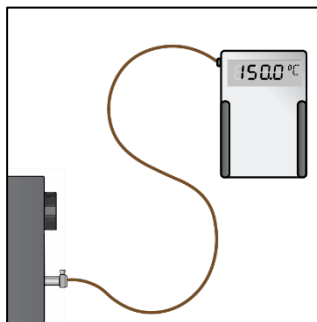

USER MAINTENANCE

Ambient?

What is the room temperature?

- For best results, measure the temperature in the same section of the room where the unit is located. Do not place your thermometer on the unit.

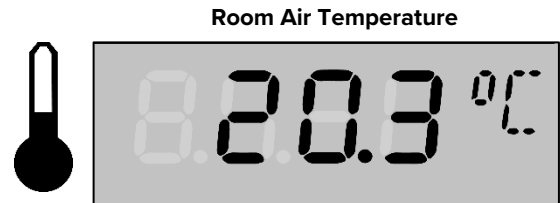

Pilot Lights?

- 1) Is the heating active indicator on the control panel flashing or otherwise illuminating.

Figure 12: Heating Indicators



“1” indicates the controller is calling for power to the element(s)



It is normal for the Heating Activated indicator to lag behind the “1” lamp on the controller display.

HEATING ACTIVATED

- 2) Is the Over Temperature Limit Activated indicator illuminating? Answer yes if the light is on continually or if it is pulsing.



OVER TEMPERATURE ACTIVATED

Share!

Share the SDRAP and Unit Specifications data with Technical Support. This data is crucial for offsite personnel making accurate remote diagnoses. The information is used to help ensure service techs are dispatched with the tools and parts needed to fix your unit during the first visit.

Facilities Technicians

SDRAP and Unit Specifications data are also useful to any institutional repair technicians at your facility who may be responsible for servicing of out-of-warranty units.

End Diagnostic Data Procedure

UNIT SPECIFICATIONS

This oven is a 220 – 240 volt unit. Please refer to the oven data plate for individual electrical specifications.

Technical data specified applies to units with standard equipment at an ambient temperature of 25°C and at nominal voltage. The temperatures specified are determined in accordance to factory standard following DIN 12880 respecting the recommended wall clearances of 10% of the height, width, and depth of the inner chamber. All indications are average values, typical for units produced in the series. We reserve the right to alter technical specifications at all times.

WEIGHT

Model	Shipping Weight	Unit Weight
SVAC1-2	132.0lbs / 60.0kg	105lbs / 47.6kg
SVAC2-2	218.0lbs / 98.8kg	179lbs / 81.2kg
SVAC4-2	452.0lbs / 205.0kg	360lbs / 163.3kg

DIMENSIONS

Inches

Model	Exterior W × D × H	Interior W × D × H
SVAC1-2	17.5 × 22.8 × 23.5	9.0 × 12.0 × 9.0
SVAC2-2	20.5 × 29.5 × 26.3	12.0 × 20.0 × 12.0
SVAC4-2	26.5 × 34.5 × 32.3	18.0 × 24.0 × 18.0

Millimeters

Model	Exterior W × D × H	Interior W × D × H
SVAC1-2	445 × 580 × 597	228 × 304 × 228
SVAC2-2	521 × 750 × 667	304 × 508 × 304
SVAC4-2	673 × 876 × 819	457 × 610 × 457

UNIT SPECIFICATIONS

CAPACITY

Model	Cubic Feet	Liters
SVAC1-2	0.56	15.9
SVAC2-2	1.67	47.2
SVAC4-2	4.50	127.4

VACUUM

Operational Vacuum Range - All Ovens

inHg	mmHg	kPa	bar
-3.0 to -29.9	-76 to -760	-10 to -101	-0.1016 to -1.0125

Vacuum Display Range – All Ovens

inHg	mmHg	kPa	bar
0.0 to -29.9	37.5 to - 757	5 to -101	0.05 to -1.013

TEMPERATURE







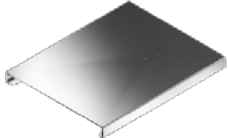

Model	Range	Stability	Uniformity
SVAC1-2	Ambient +10° to 220°C	± 0.1°C @ 150°C	±6% of Set Point
SVAC2-2	Ambient +10° to 220°C	± 0.2°C @ 150°C	±6% of Set Point
SVAC4-2	Ambient +10° to 220°C	± 0.25°C @ 150°C	±6% of Set Point

POWER

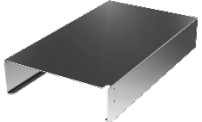
Model	AC Voltage	Amperage	Frequency
SVAC1-2	220 - 240	4.5	50/60 Hz
SVAC2-2	220 – 240	5.5	50/60 Hz
SVAC4-2	220 - 240	7.0	50/60 Hz

REPLACEMENT PARTS LIST

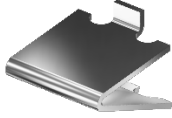
See the next page for gaskets

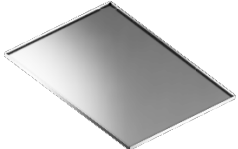
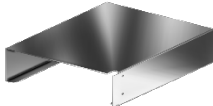
Description	Parts Number	Description	Parts Number
Adjustable Leveling Feet, SVAC2-2	 2700512	Shelf Short, SVAC1-2	 5680519
Adjustable Leveling Feet, SVAC4-2	 2700506	Shelf Tall, SVAC2-2	 5680567
Fuses, T16A 250V 5x20mm (Requires 2)	 3300513	Shelf Short, SVAC2-2	 9751226
Power Cord 250Volt, 10Amp, 8ft 2in (2.5m), CEE 7/7 Shucko	 1800500	Shelf Clip, Individual (1), SVAC4-2	 1250510
Power Cord 240 volt, 15Amp, 8ft 2in (2.5m) NEMA 6-15P	 1800539	Shelf, SVAC4-2	 5680563
Shelf Tall, SVAC1-2	 5680506		

REPLACEMENT PARTS LIST

REPLACEMENT GASKETS

Available Gaskets Types	Part Number
<p>Silicon, black or red, (comes with oven), rated to 230°C</p> <p>Applications: General and high temperature</p> <p>Resistant to: Moderate or oxidizing chemicals, ozone, and concentrated sodium hydroxide</p> <p>Attacked by: Many solvents, oils, concentrated acids, and diluted sodium hydroxide</p>	<p>SVAC1-2: 3450706</p> <p>SVAC2-2: 3450707</p> <p>SVAC4-2: 3450719</p>
<p>Buna rated to 105°C</p> <p>Applications: Solvent</p> <p>Resistant to: Many hydrocarbons, fats, oils, greases, and hydraulic fluids.</p> <p>Attacked by: Ozone (except PVC blends), ketones, esters, aldehydes, chlorinated, and nitro hydrocarbons.</p>	<p>SVAC1-2: 3450712</p> <p>SVAC2-2: 3450708</p> <p>SVAC4-2: 3450724</p>
<p>Fluorosilicone rated to 175°C</p> <p>Applications: Acidic</p> <p>Resistant to: Moderate or oxidizing chemicals, ozone, aromatic chlorinated solvents, and bases.</p> <p>Attacked by: Brake fluids, hydrazine, and ketones.</p>	<p>SVAC1-2: 3450610</p> <p>SVAC2-2: 3450611</p> <p>SVAC4-2: 3450612</p>
<p>Viton® rated to 205°C</p> <p>Applications: Acidic</p> <p>Resistant to: All aliphatic, aromatic and halogenated hydrocarbons, acids, and animal and vegetable oils.</p> <p>Attacked by: Ketones, low molecular weight esters, and compounds containing nitro.</p>	<p>SVAC1-2: 3450669</p> <p>SVAC2-2: 3450670</p> <p>SVAC4-2: 3450671</p>
<p>Gasket Dimensions</p> <p>SVAC1-2 – 9.2 X 9.3 Inches (22.86 x 22.86cm)</p> <p>SVAC2-2 – 12 x 12 Inches (30.48 x 30.38cm)</p> <p>SVAC4-2 – 18 x 18 Inches (45.72 x 45.72cm)</p>	

Ordering Parts and Consumables

If you have the Part Number for an item, you may order it directly from Sheldon Manufacturing by calling 1-800-322-4897 extension 3. If you are not certain that you have the correct Part Number, or if you need that specific item, please contact Sheldon Technical Support for help at 1-800-322-4897 extension 4 or (503) 640-3000. Please have the **model** and **serial number** of the oven ready, as Tech Support will need this information to match your unit to its correct part.

REPLACEMENT PARTS LIST

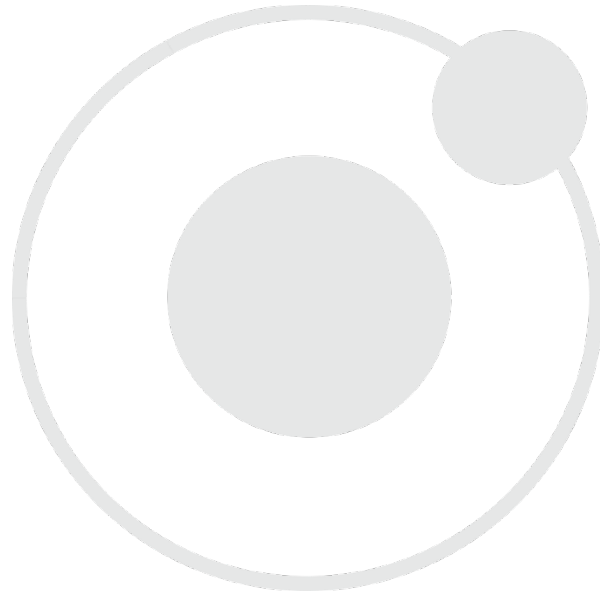



Sheldon Manufacturing, INC
P.O. Box 627
Cornelius, Oregon, 97113
USA

EMAIL: tech@shellab.com
INTERNET: Shellab.com
PHONE: 1-800-322-4897
(503) 640-3000
FAX: 503 640-1366