

Product datasheet

Captair 321

Ductless filtering fume hoods

Safer to operate

- Erlab's advanced carbon filtration technology and/or HEPA/ULPA accommodates your specific needs
- Meets AFNOR NF X 15 211/ANSI Z9.5-2012 filtration efficiency standard (class 1* and 2)
- Sensors that detect filter breakthrough of solvents, acids or formaldehyde*
- Safety back up filter in case of main filter saturation
- Continuous monitoring of Air face velocity
- Erlab Safety Program: application analysis and validation, usage certification, filter change reminders
- Connect with eGuard for real-time status, notifications and alerts*

Simpler to use

With Smart-Light, you can easily see that the hood is operating safely. Should the light pulse you are notified that*:

- Containment has been compromised or,
- The filter has breakthrough or,
- There is a Fan failure

Flexibility

- The configurable filtration column will accommodate application changes
- No ductwork needed. This allows you to move the hood anywhere.

Savings

- No ductwork cost
- Annual energy costs decreases significantly
- Energy savings outweigh filter replacement costs.

Environment

- No dangerous chemical released into the atmosphere
- Low energy consumption



You get the highest level of filtration performance.



Smart-Light keeps you safe.



Connect your equipment and download the eGuard App for remote access.



Download our eGuard application



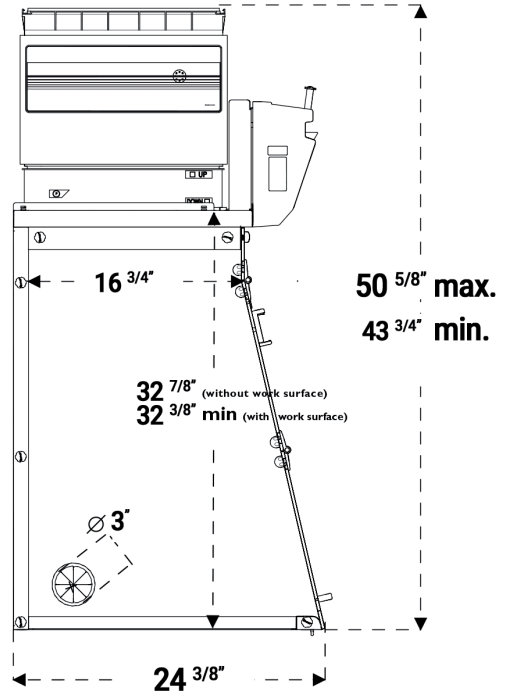
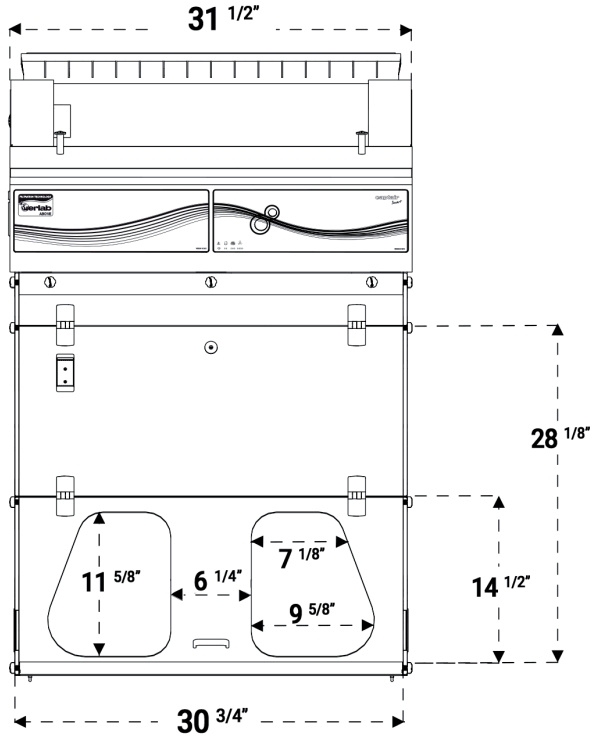

Heights according to the filtration column configuration		
Type 1C or 1P	43 7/8"	Please add 5 3/4" between the last filter and the ceiling to allow good air recirculation and to replace filters easily.
Type 2C or 1P1C or 1C1P*	47 1/2"	
Type 1P2C or 1P1C1P*	50 5/8"	

Work surfaces with built in spill tray

Tempered glass
Retention volume (4L)

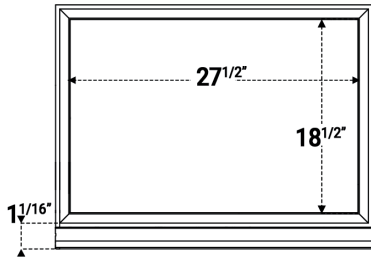

TRESPA® TOPLAB^{PLUS}
Retention volume (4L)

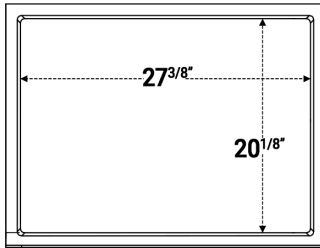

304 L stainless steel
Retention volume (9L)

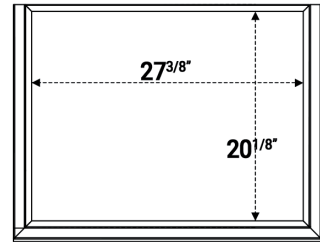

Benchcap: fixed work bench

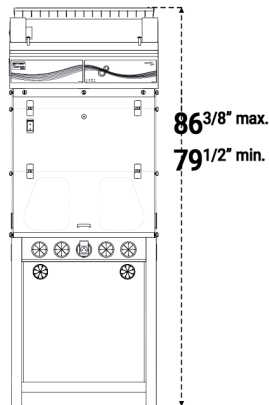

Mobicap : mobile rolling cart

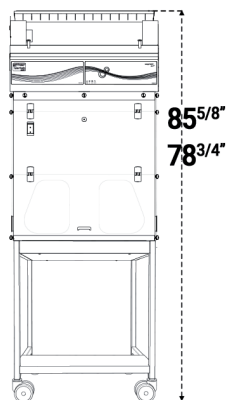

Designed with you in mind: Our filtration column can be configured for your specific application requirements.

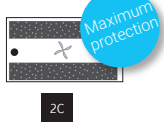
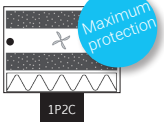
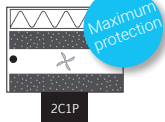
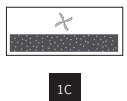
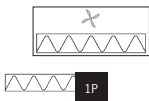
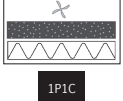
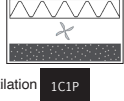
		Products handled / Applications			
		Liquid chemicals handlings	Powders handlings	Liquid chemicals and powders handlings	Liquid chemicals handlings in clean room
Customized filtration column	Class 1* according to the NF X 15-211		NA		
	Class 2 according to the NF X 15-211				

Available filters :

Carbon filtration for gases and vapours
 AS:For organic vapours
 BE+:Polyvalent for acid + organic vapours
 F:For formaldehyde vapours
 K:For ammonia vapours

Particulate filtration for powders
 HEPA H14:99.995 % efficiency filtration of particles over 0.1 µm in size
 ULPA U17:99.999995 % efficiency filtration of particles over 0.1 µm in size

- **Molecode**
Automatic alarm to detect a filtration fault

Safety Standards	AFNOR NF X 15-211:2009: France - BS 7989: England DIN 12 927:Germany - EN 1822:1998 (HEPA H14 & ULPA U17 Filters) - CE Marking
Air Flow	220 m3/h - 129 CFM
Air Face Velocity	0.4 to 0.6 m/s - 79 fpm to 118 fpm
Voltage/Frequency	90-220 V / 50-60 Hz
Power consumption	65 W
Sash openings	Oblong
Structure	Corrosion resistant electro-galvanized steel coated with anti-acid polymer
Side and front panels	Chemical resistant acrylic
Filtration module	Polypropylene

Equipment

Communication interface*	Simple communication by audible and light pulses: air face velocity, automatic alarm to detect a filtration fault, ventilation settings, fan failure alarm
Filtration technology	1 column that can be configured to handle liquids, powders, or both
Carbon filtration for gases and vapours	Following filtration column configuration (see table above)
Particulate filtration for powders	Following filtration column configuration (see table above)
eGuard*	APP for remote control to monitor the hood, and deliver safety alerts immediately to your devices (mobile, tablet and PC)
Internal lighting*	LED lighting > 650 Lux
Anemometer*	Air face velocity alarm
Chemical Listing	List of approved chemicals

Accessories

Work Surfaces	TRESPA® TOPLAB ^{PLUS} , Glass or 304L Stainless Steel
Molecode*	Detection sensor for : Type S, for solvents / Type A, for acids / Type F, for formaldehyde
Benches	Mobile (Mobicap) or fixed (Benchcap)
Particulate Pre-filter	Protects the main filter(s) from dust
Transparent Back Panel	Clear acrylic panel for easy viewing



Erlab's state of the art Research & Development Laboratory relies exclusively on filtration

About Erlab

We provide safety, we protect your health

Erlab invented the ductless fume hood in 1968. With more than 50 years of experience in the field of chemical filtration and protection of laboratory personnel; we know the formula for safety. With Erlab, you will never have to wonder or worry if our products are safe. We build each one of the following 7 ingredients into our products, and without all of them, your health and safety will be compromised.

1 Erlab R&D Laboratory

The engineers and chemists in our state-of-the-art R&D laboratory understand molecular filtration. We are committed to designing products that are safe and of the highest quality, strive to improve our products, and continuously develop new products that provide greater protection in the laboratory.

2 Strict Safety Standards

We hold ourselves to the highest standard and adhere to the strict AFNOR NF X 15-211: 2009 filtration safety standard as cited by ANSI Z9.5-2012.

3 A Published Chemical Listing

It all begins here. Without this listing, we are not compliant with AFNOR NF X 15-211. Our in-house laboratory tests, as well as independent testing, to verify the retention capacity of over 700 chemicals for our filters.

4 Independent Testing

Erlab filters have been independently tested multiple times at various concentrations guaranteeing that our safety solutions all adhere to the strict performance criteria of the AFNOR NF X 15-211:2009 standard assuring that the emission concentration at the filter exhaust will always be lower than 1% of the TLV.

5 Application Questionnaire (Valiquest)

Our laboratory specialists will recommend the appropriate filtration fume hood, type of filter, and personalized advice.

6 Certificate of Validation for the chemicals used in the hood

A certified PhD chemist issues a Certificate of Validation with a list of the chemicals approved for use in the hood.

7 Our Safety Program

We back up our products 100%. This program includes your specialized chemical evaluation, validation of your hood upon installation, and a filtration safety specialist at your service to ensure that your hood is operating to its full potential.



VWR.COM

Prices, product, and/or services details are current when published and subject to change without notice. | Certain products or services may be limited by federal, state, provincial, or local regulations. | VWR, part of Avantor, makes no claims or warranties concerning sustainable/green products. Any claims concerning sustainable/green products are the sole claims of the manufacturer and not those of VWR International, LLC and/or Avantor, Inc. or affiliates. All prices are in US dollars unless otherwise noted. Offers valid in US and Canada unless otherwise noted, void where prohibited by law or company policy, while supplies last. | Trademarks are owned by Avantor, Inc. or its affiliates, unless otherwise noted. | Visit vwr.com to view our privacy policy, trademark owners, and additional disclaimers. © 2021 Avantor, Inc. All rights reserved.