

Start up Guide

A-Series

Balance Series

1. CONTENT

Models: VWR-105AC | VWR-205AC

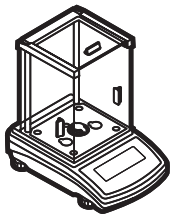

Balance
x 1



Weighing pan
x 1



Draft shield
x 1

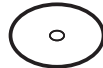

Centering ring
x 1

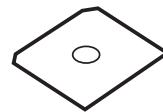

Bottom insert
x 1

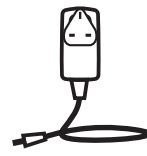

Power adapter
x 1

Models: VWR-160AC | VWR-220AC | VWR-310AC | VWR-520AC

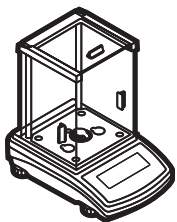

Balance
x 1



Weighing pan
x 1



Draft shield
x 1

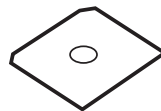

Bottom insert
x 1

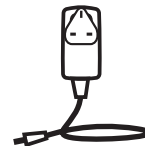

Power adapter
x 1

Models: VWR-363AC | VWR-603AC | VWR-1003AC

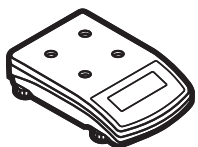

Balance
x 1



Weighing pan
x 1

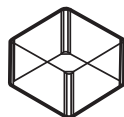

Draft shield
x 1



Grounding foot
x 1



Foot
x 3

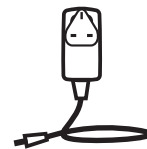

Power adapter
x 1

Models: VWR-2102AC

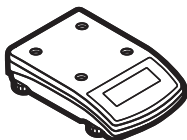

Balance
x 1



Weighing pan
x 1



Grounding foot
x 1



Foot
x 3

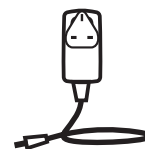

Power adapter
x 1

Models: VWR-4502AC | VWR-6002AC | VWR-8102AC | VWR-10102AC

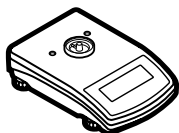

Balance
x 1



Weighing pan
x 1



Draft shield
x 1

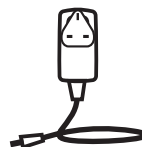

Power adapter
x 1

2. WORKROOM AND BASIC OPERATION GUIDELINES

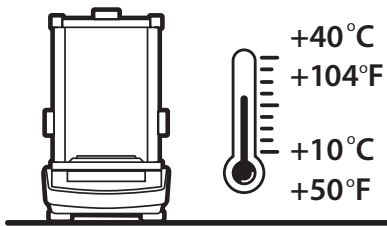

Operate the device in a room where the temperature ranges between 10–40 °C (50–104 °F) and where the relative humidity is below 80%.

Place the balance on a solid surface to ensure stability. To obtain stable and repeatable weighing results, an anti-vibration table is recommended.

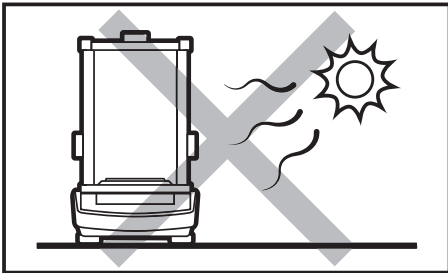

Place the balance away from heat sources. Avoid exposing the balance to the sunlight.

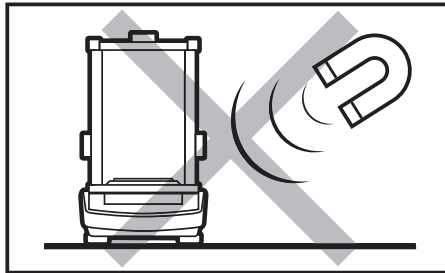

Avoid exposing the balance to a magnetic field. Do not weigh magnetic substances.

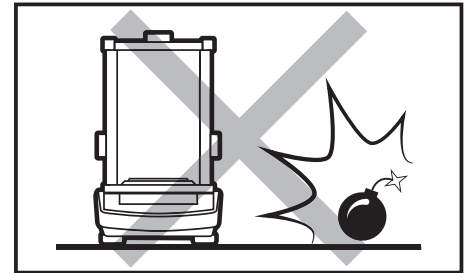

Do not place the balance in a hazardous area. Do not weigh explosive materials.

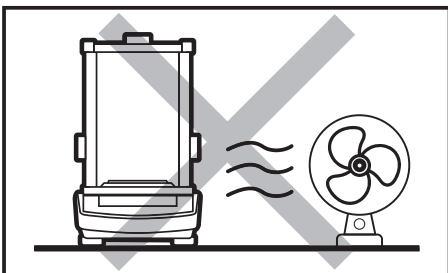

Avoid air drafts and air movements at the workstation.

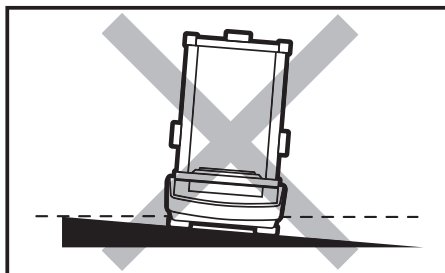

Make sure that the balance is placed on an even surface.

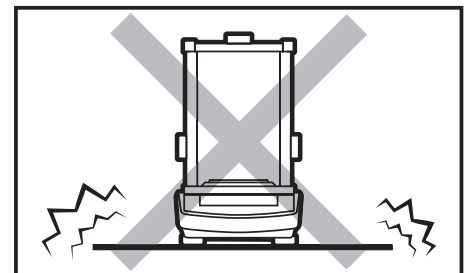

Do not place the balance on an unstable ground exposed to shocks and vibrations.

3. UNPACKING

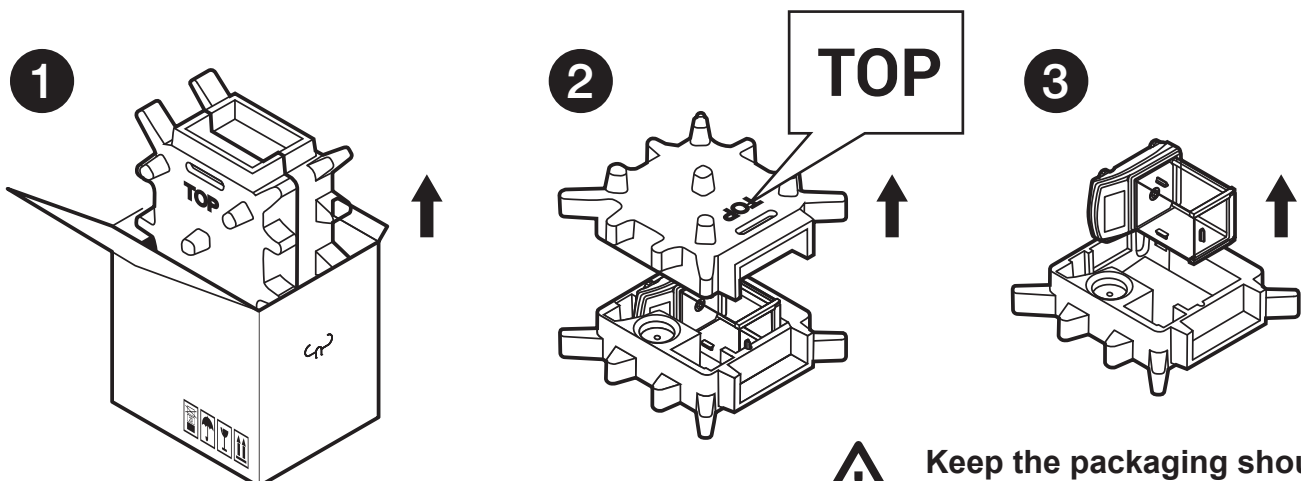

Keep the packaging should a warranty claim or service be required.

4. ACTIVITIES TO BE DONE PRIOR TO OPERATION

4.1. Remove transport lock

Models: VWR-105AC | VWR-205AC | VWR-160AC | VWR-220AC | VWR-310AC | VWR-520AC

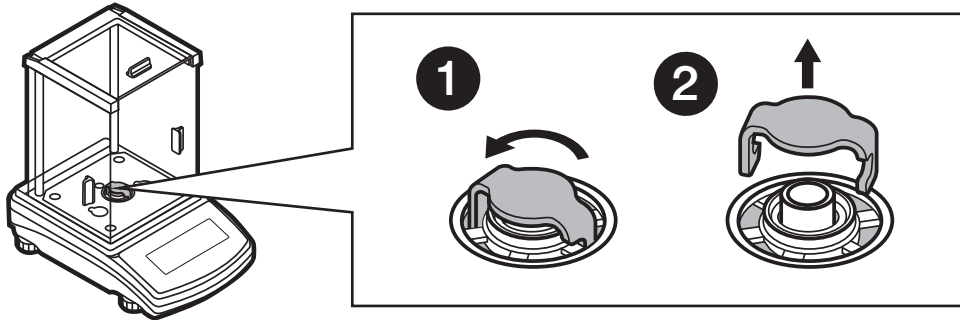

Keep the transport lock should a warranty claim or service be required.

Models: VWR-363AC | VWR-603AC | VWR-1003AC | VWR-2102AC

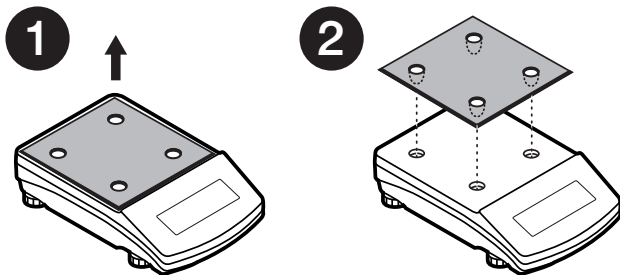

Keep the transport lock should a warranty claim or service be required.

4.2. Grounding spring check

Models: VWR-105AC | VWR-205AC | VWR-160AC | VWR-220AC | VWR-310AC | VWR-520AC

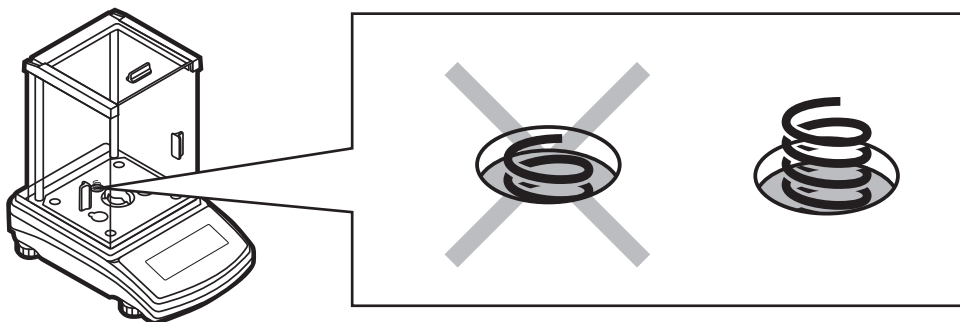

Check the grounding spring. Make sure that the grounding spring juts slightly out of the hole.

Models: VWR-363AC | VWR-603AC | VWR-1003AC | VWR-2102AC

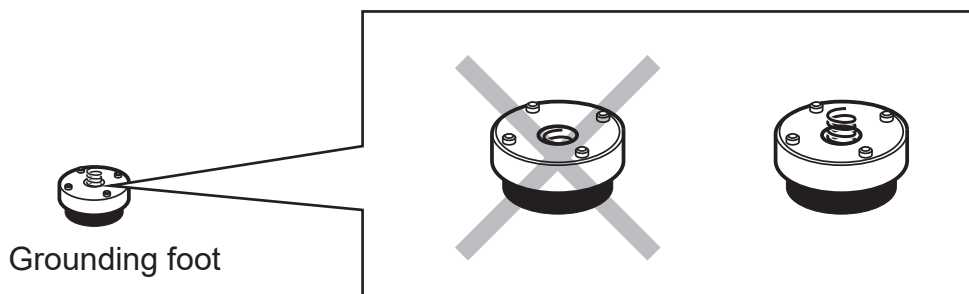

Check the grounding spring. Make sure that the grounding spring juts slightly out of the hole.

5. COMPONENTS ASSEMBLY

Models: VWR-105AC | VWR-205AC

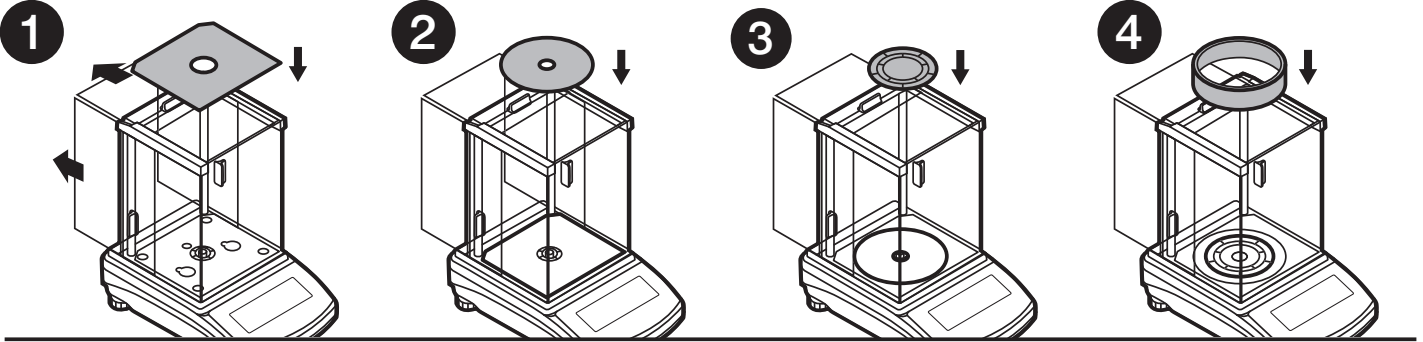

Models: VWR-160AC | VWR-220AC | VWR-310AC | VWR-520AC

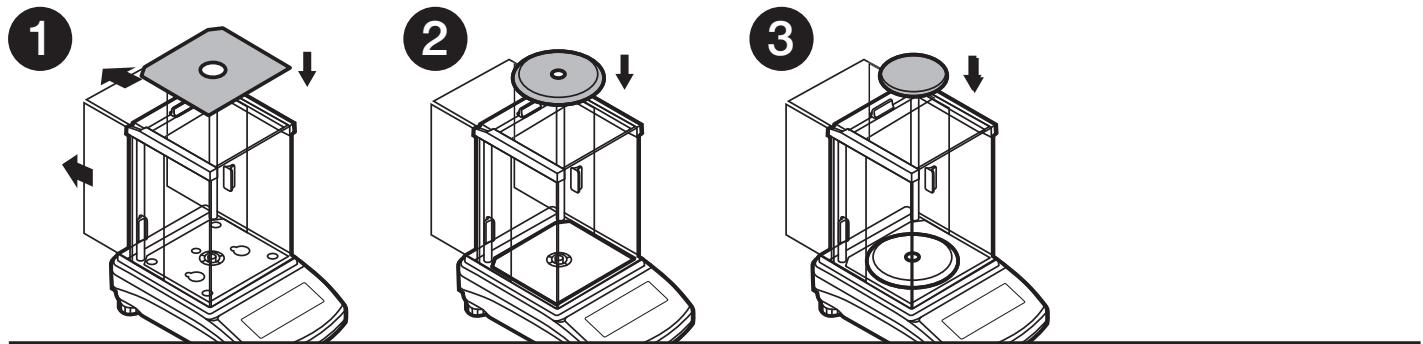

Models: VWR-363AC | VWR-603AC | VWR-1003AC

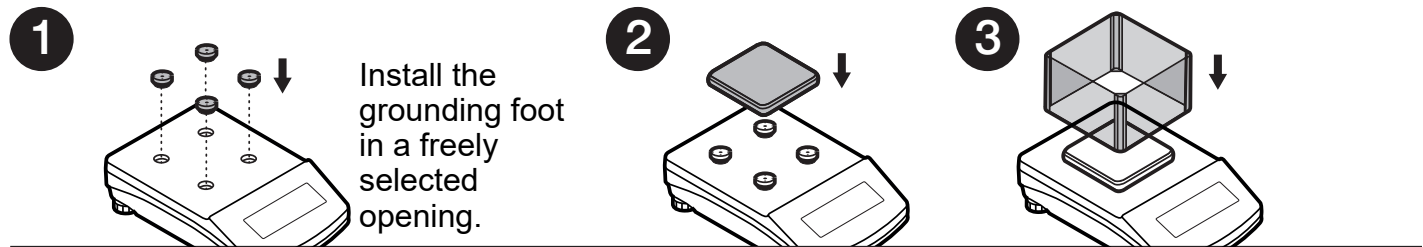

Models: VWR-2102AC

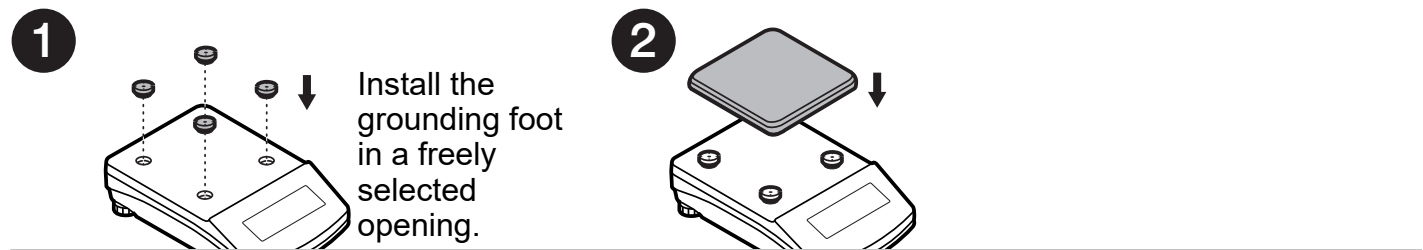

Models: VWR-4502AC | VWR-6002AC | VWR-8102AC | VWR-10102AC

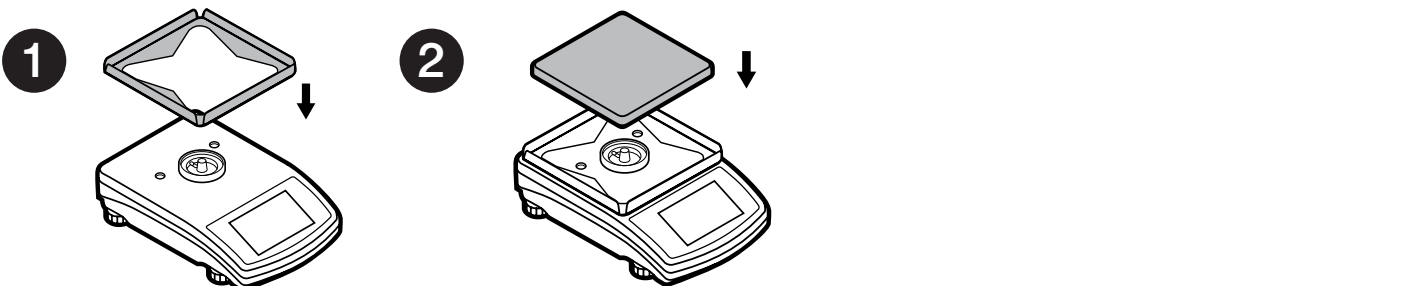

6. PREPARING FOR WORK

6.1. Balance temperature stabilization time

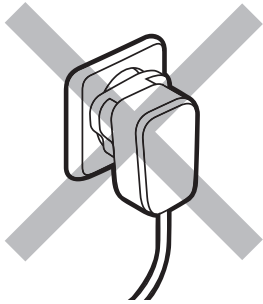

Prior to switching the device on it is necessary to ensure that it has reached a temperature equal to room temperature.

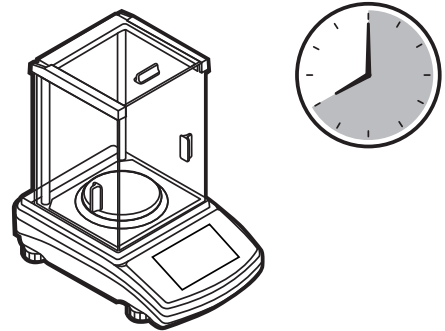

Balance temperature stabilization time ranges between 1 - 8 hours.

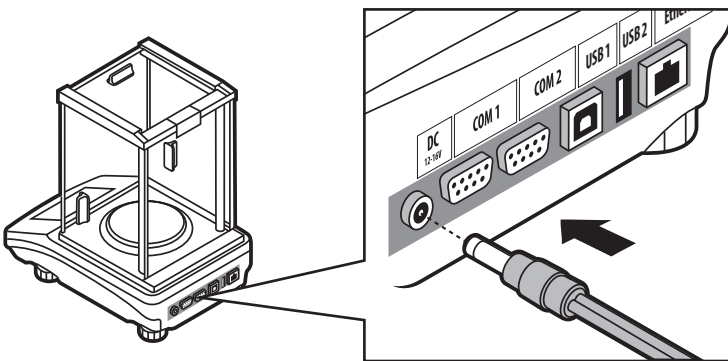

Connect the power adapter to DC connector.

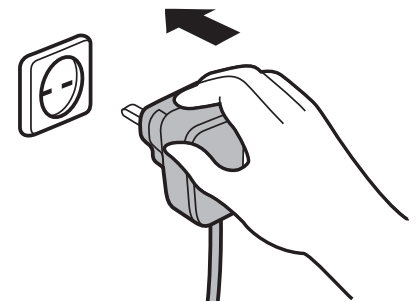

Connect the power adapter to the mains.

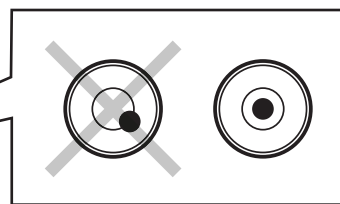
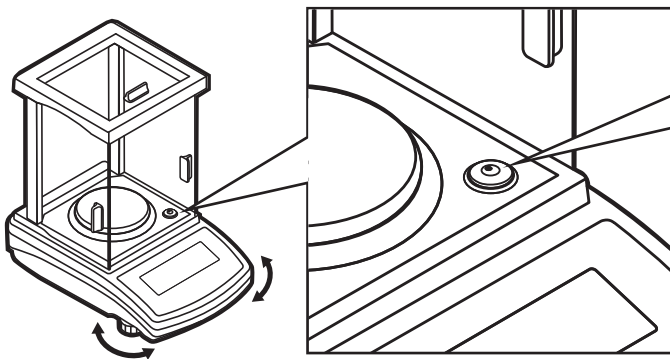

To level the semi-micro and analytical balances, turn its feet and keep turning the feet until the air bubble takes the central position. The leveling vial is located in the front of the weighing chamber.

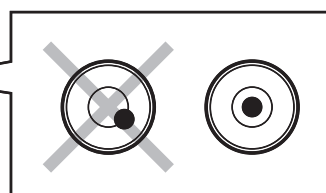
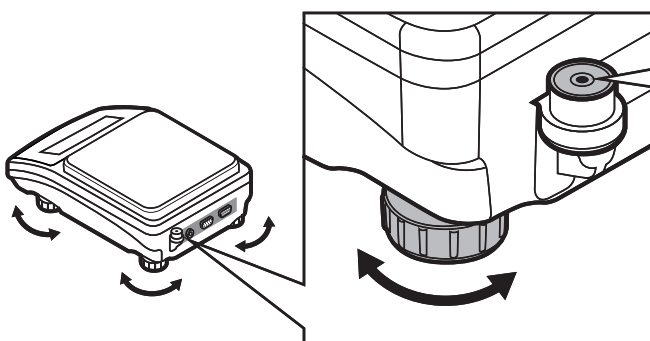

To level the precision balances, turn its feet and keep turning the feet until the air bubble takes the central position. The leveling vial is located at the rear of the unit.

7. PANEL AND SCREEN

7.1. Panel keys

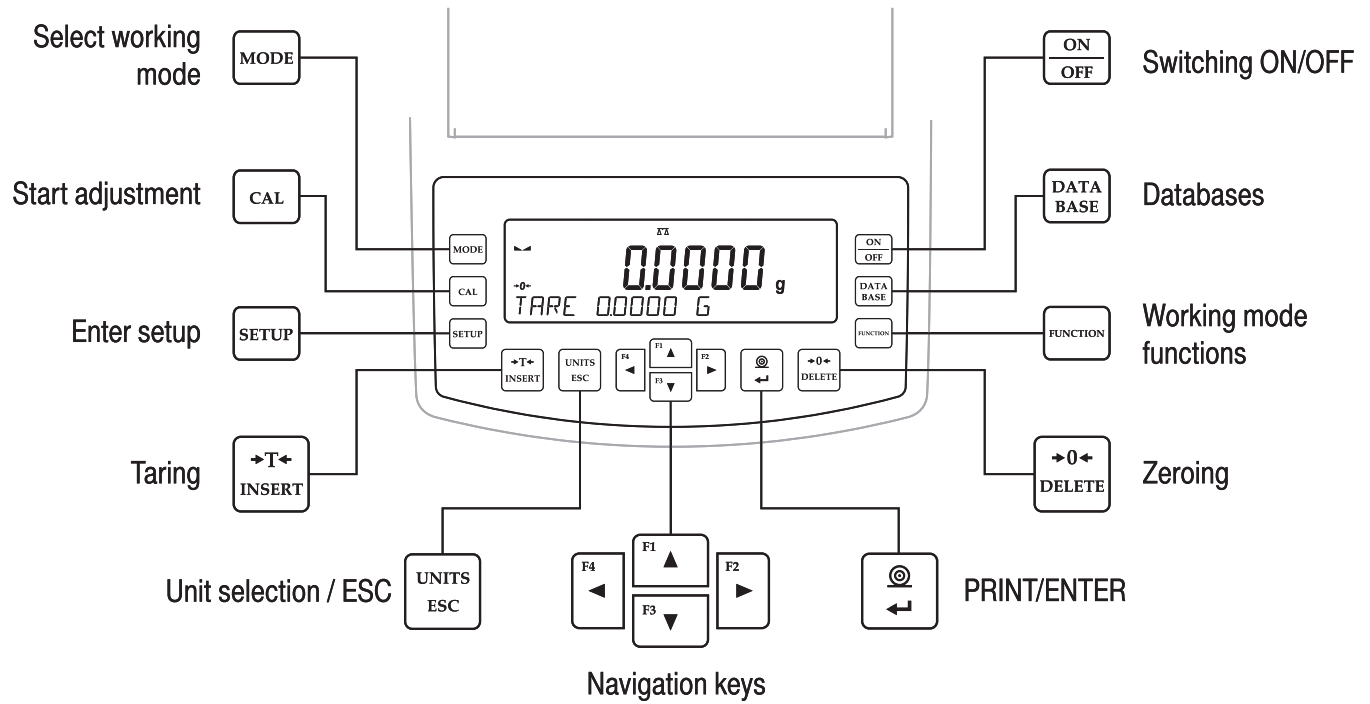

7.2. Home screen

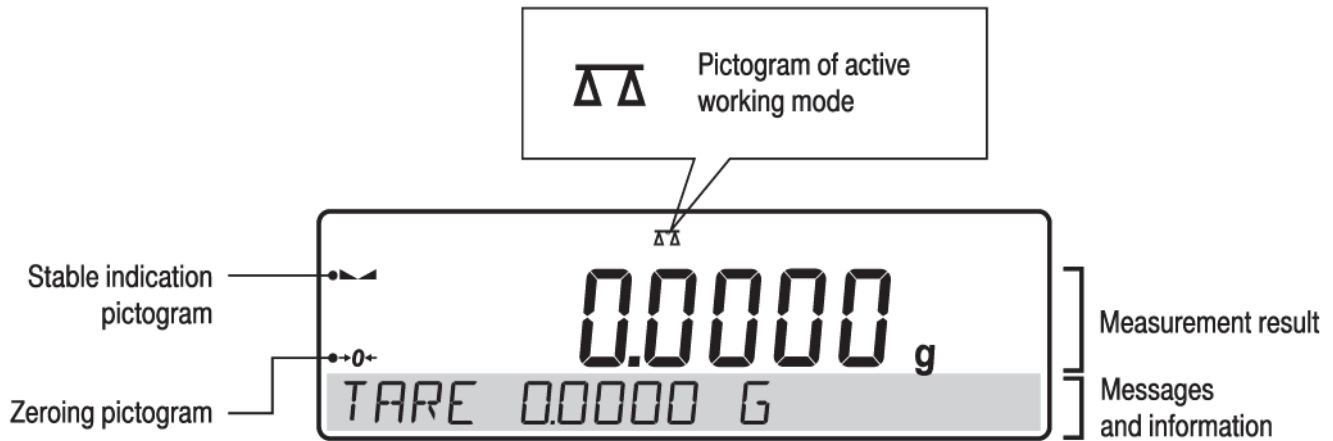

8. BASIC OPERATIONS

8.1. Adjustment

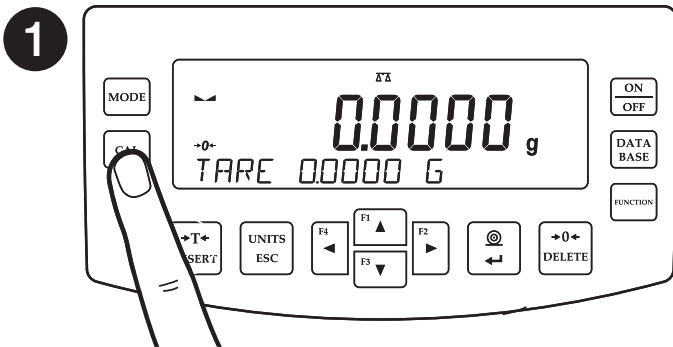

Press **CAL** key to start the adjustment

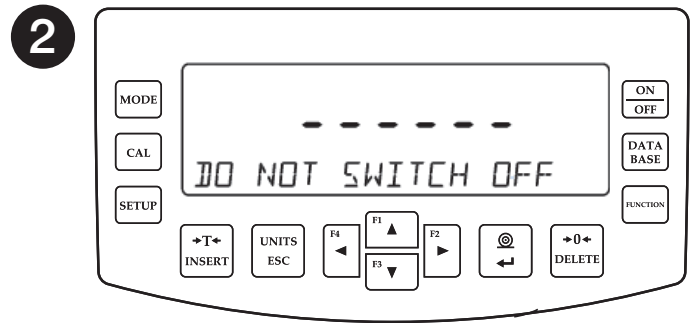

Wait for the adjustment completion.

8.2. Zeroing

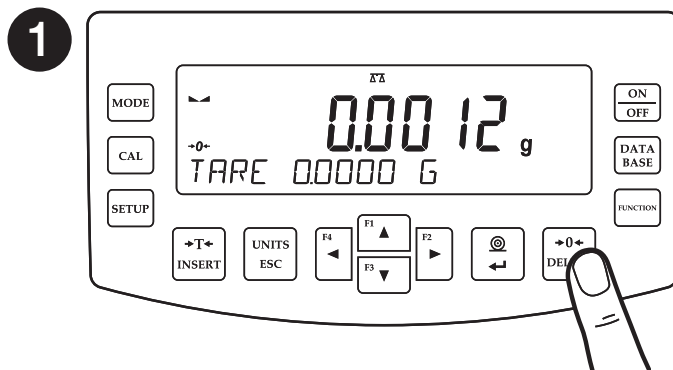

Unload the weighing pan and press "Zeroing" button.

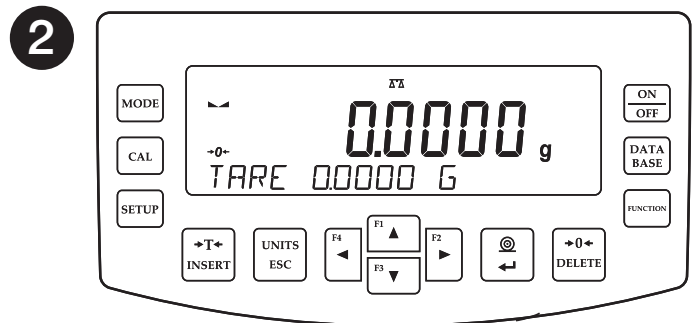

The balance has been zeroed.

8.3. Taring

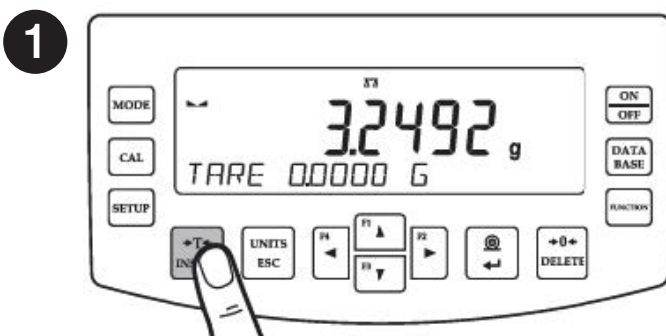

When the weighing result has been displayed press "Tare" button.

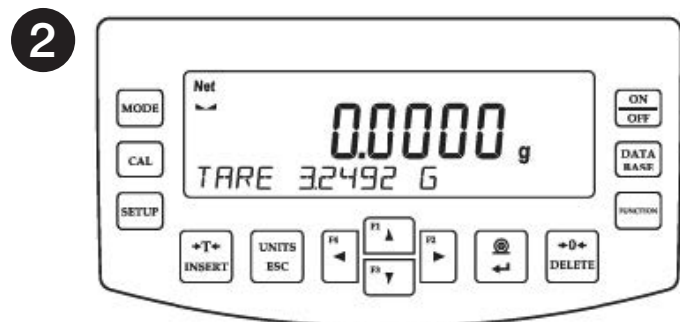

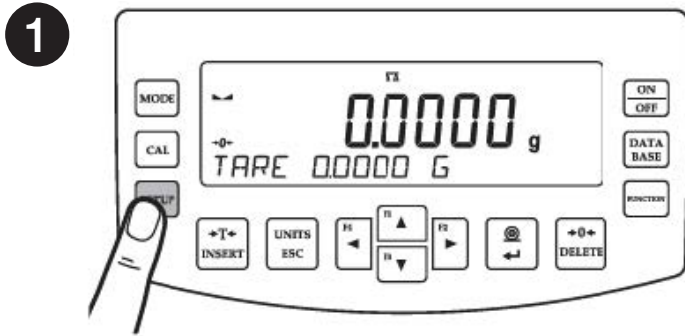

The balance has been tared.

8.4. Working modes accessibility

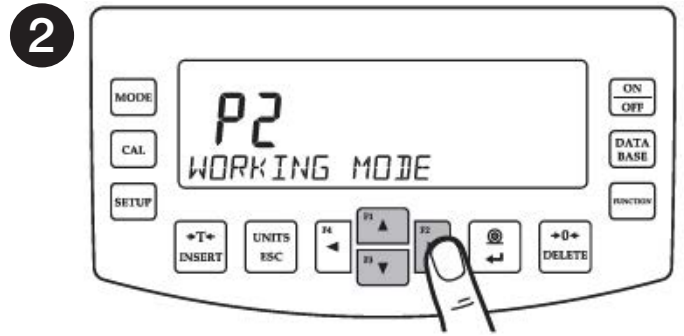

Press  to enter "Setup" menu.



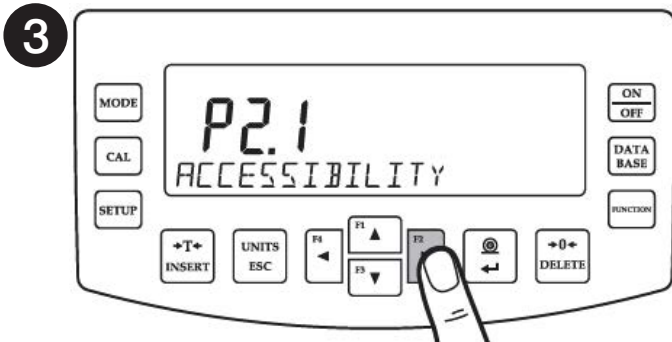

Using  keys select "Working mode" and press  key



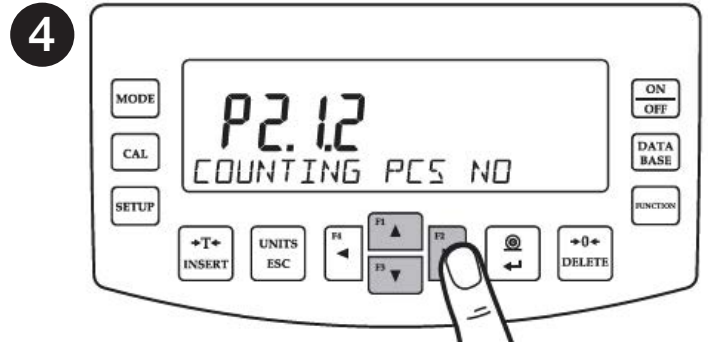

In the "Accessibility" position, press  key

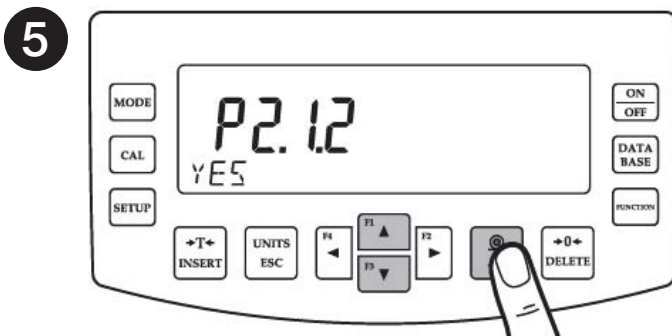

Using  keys to select working modes for which accessibility is to be set and press  key.



Using  keys to set accessibility parameter to "Yes" value for a selected working mode and press  key to confirm.

 In order to enable other working modes, repeat the steps: **4** and **5**.

8.5. Selecting working mode

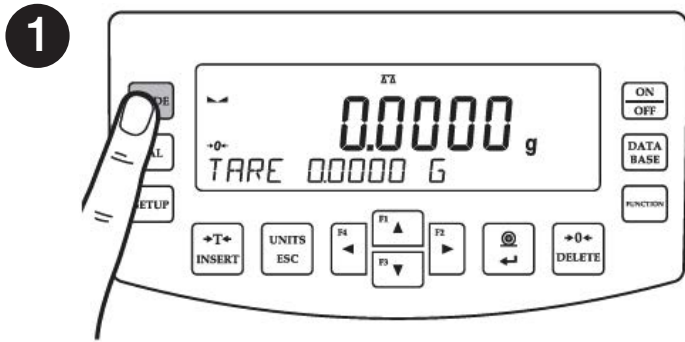

Press **MODE** key to enter working modes menu.

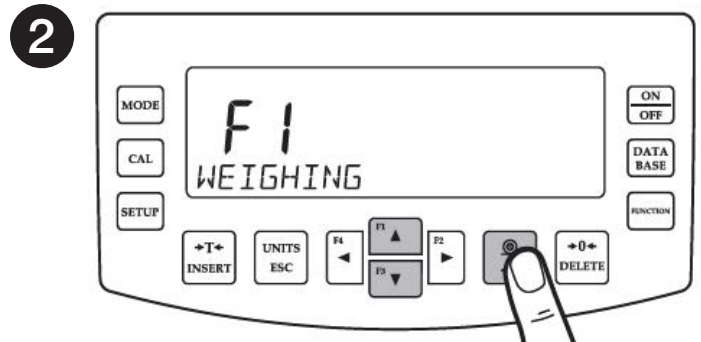

Using **F1** keys, select working mode and press **F1** key to confirm.

The menu features the following working modes:

- Weighing
- Parts counting
- Checkweighing
- Dosing
- Deviations
- Density Determination of Solids
- Density Determination of Liquids
- Statistics
- Totalising
- Peak Hold
- Pipettes Calibration



Detailed overview of the settings of the working modes is to be found in balance's main user manual.

8.6. Weighing unit accessibility

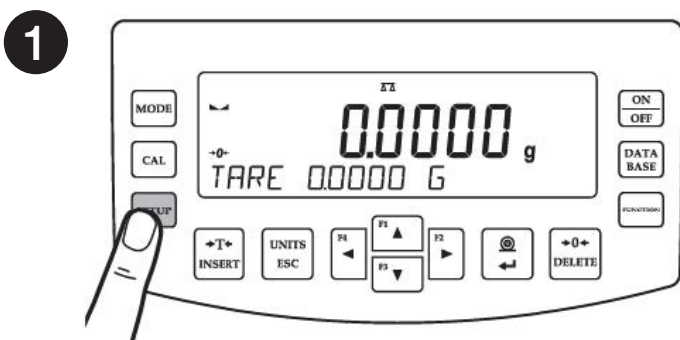

Press **SETUP** to enter "Setup" menu.

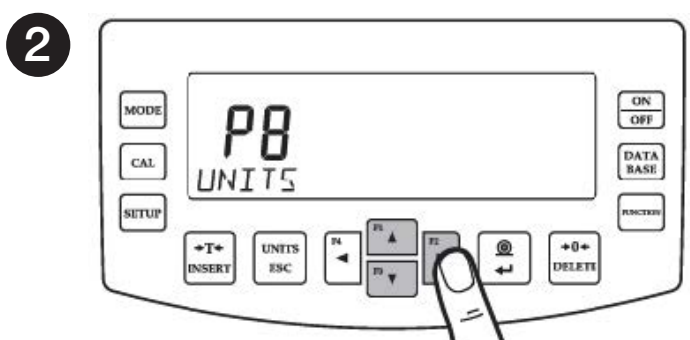

Using **F2** keys, select "Units" and press **F2** key

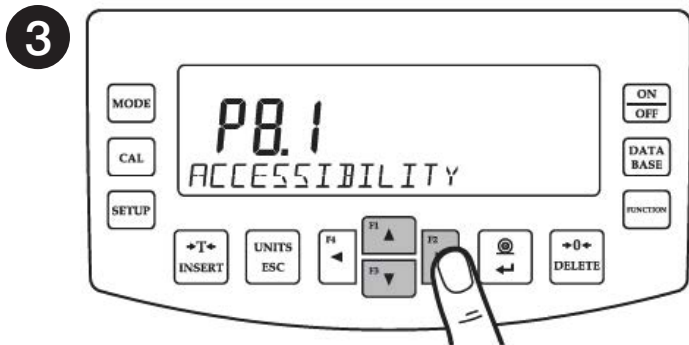

In the "Accessibility" position, press

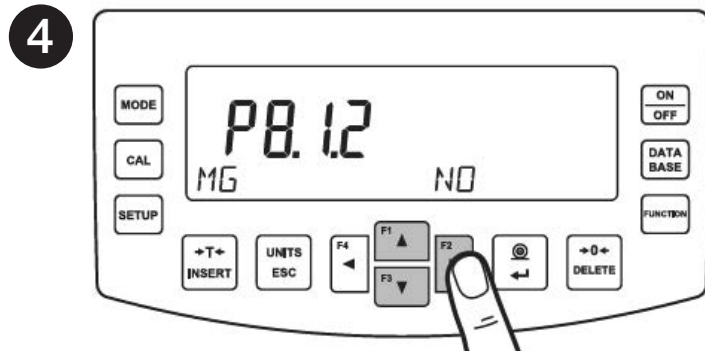

Using keys to select unit for which accessibility is to be set and press key.

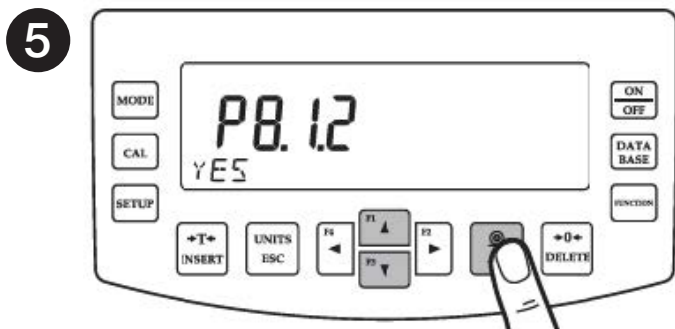

Using keys to set accessibility parameter to "Yes" value for a selected working mode and press key to confirm.

In order to enable other working modes, repeat the steps: **4** and **5**.

8.7. Weighing unit selection

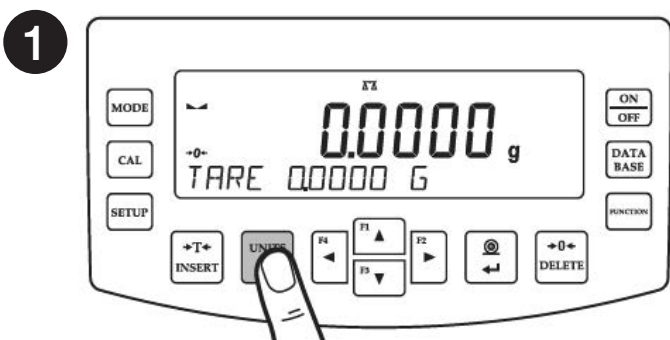

Press key to select the weighing units

The balance enables selecting the following weighing units:

- Gram [g]*
- Miligram [mg]*
- Kilogram [kg]*
- Carat [ct]*
- Pound [lb]
- Ounce [oz]
- Troy ounce [ozt]
- Pennyweight [dwt]
- Hong Kong Tael [tlh]
- Singapore tael [tls]
- Taiwanese tael [tlt]
- Chinese tael [tlc]
- Momme [mom]
- Grain [gr]
- Tical [ti]
- Newton [N]

** Units available for verified balances exclusively*

9. SETTINGS



Some balance settings are accessible for Administrator exclusively. Prior balance parameters setup, log in as the Administrator.

9.1. Administrator's login

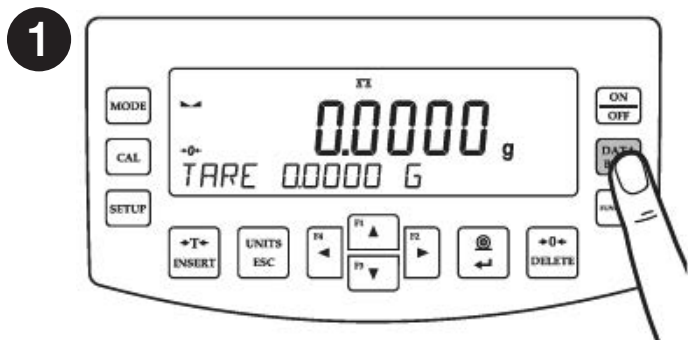

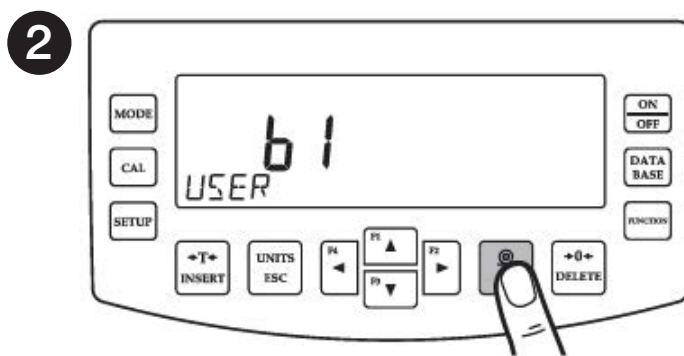

Press  key to enter "Database" menu



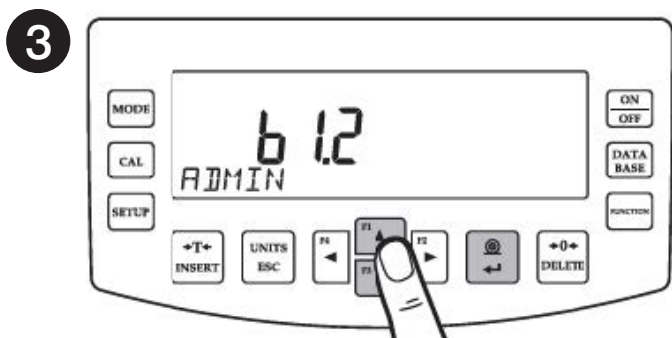



To enter user parameters, press  key

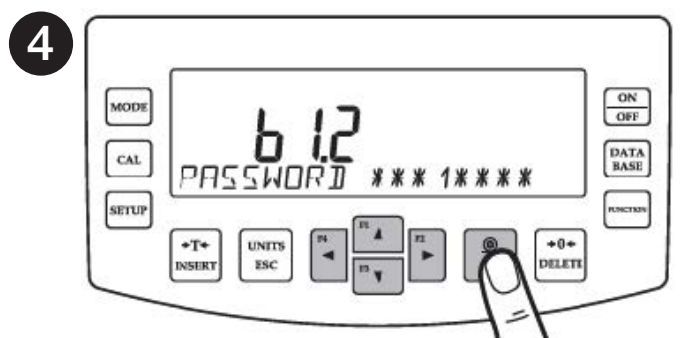

Using   keys select "Admin" and press  key to confirm



Using    keys select "1111" and press  key to confirm.

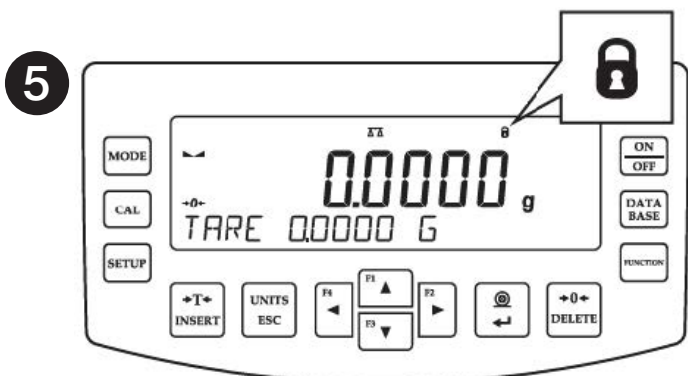

You have logged in as the administrator.





Upon logging in pictogram is displayed 

9.2. User settings



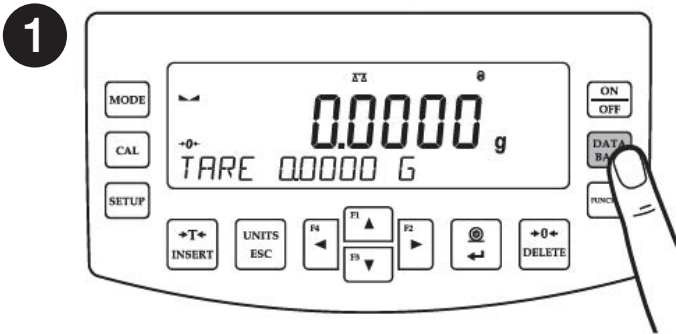

Prior balance users setup, log in as the Administrator.

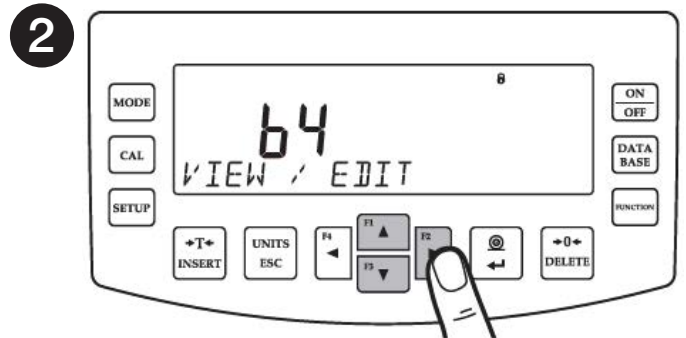

Press  key to enter "Database" menu



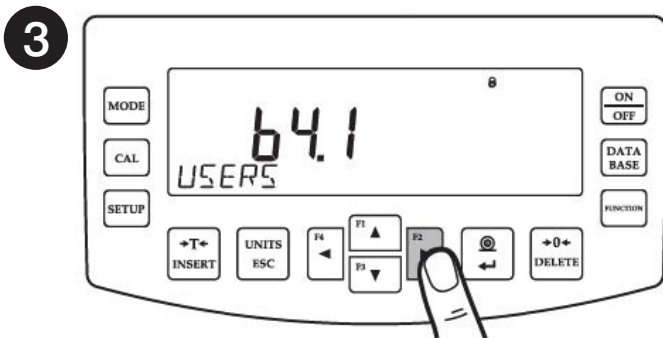

Using   keys to select "View/Edit" and press  key to confirm

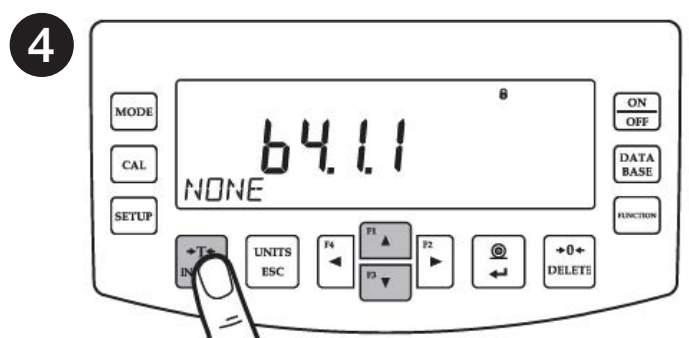

To select "Users" parameters, press  key



Using   keys select "Admin" and press  key to confirm

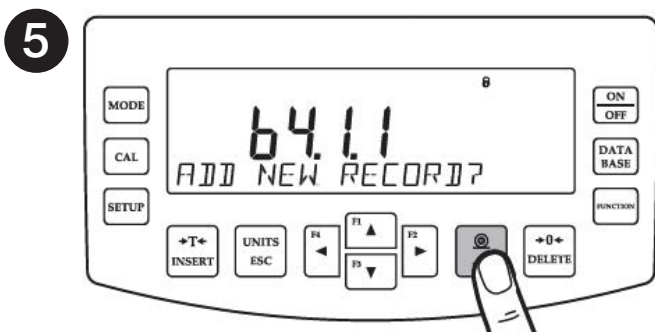

Press  key to add new user.



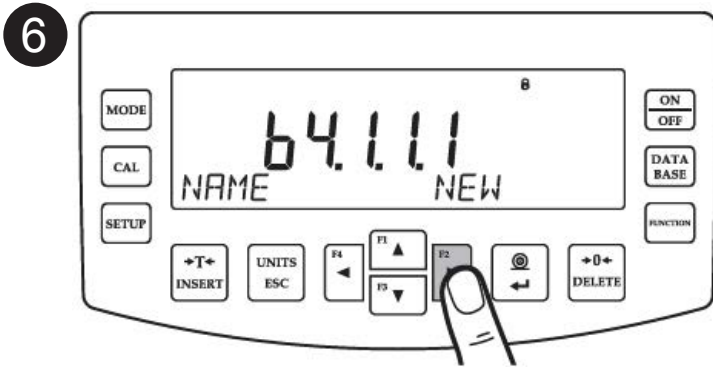

In the following steps, set:

- User name
- Code
- Password
- Permissions level
- Language

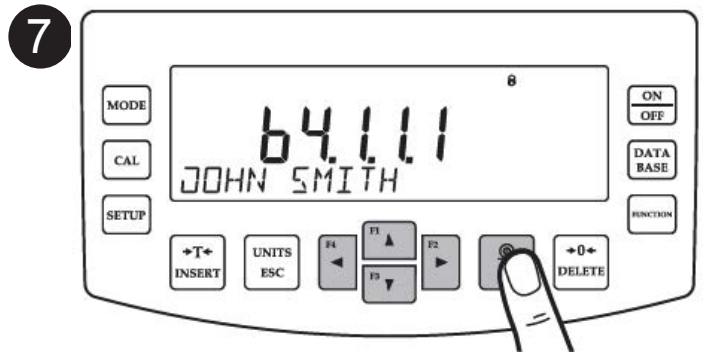



Press  key to add new user.



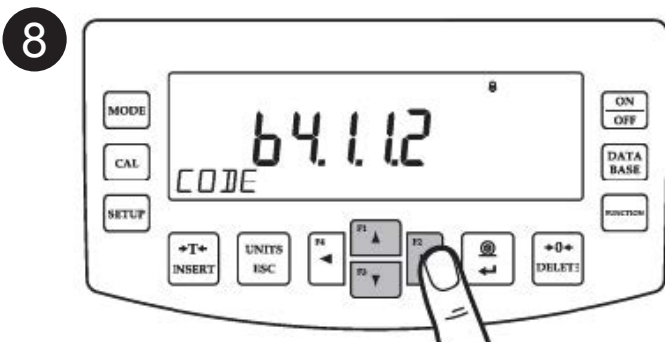



Using    keys to enter user name and press  key to confirm

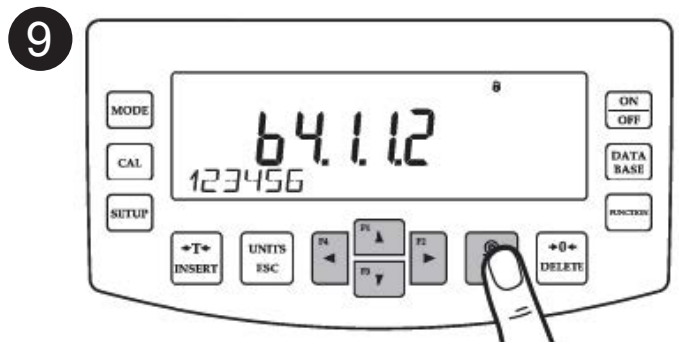



Using   keys select "Code" and press  key



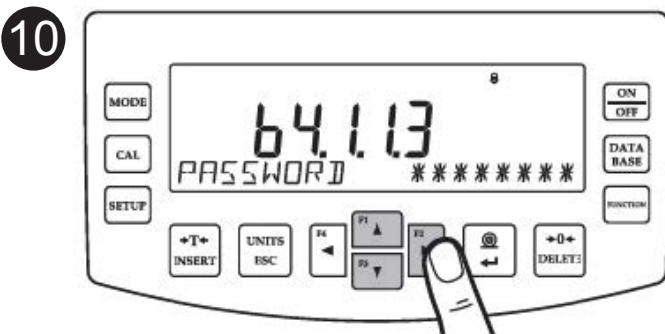



Using    keys enter user code and press  key to confirm

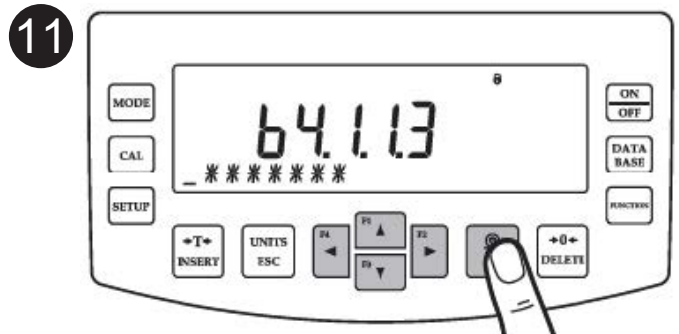





Using   keys select "Password" and press  key to confirm

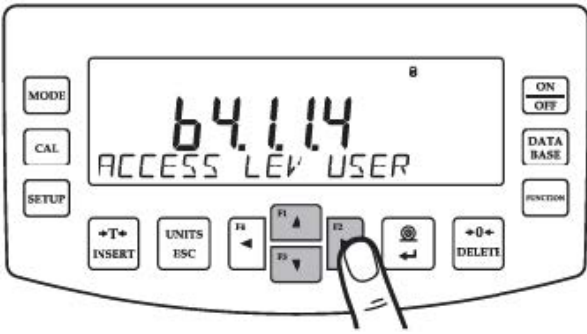

Using    keys enter user password and press  key to confirm



12



Using   keys select "Access Level" and press  key to confirm.

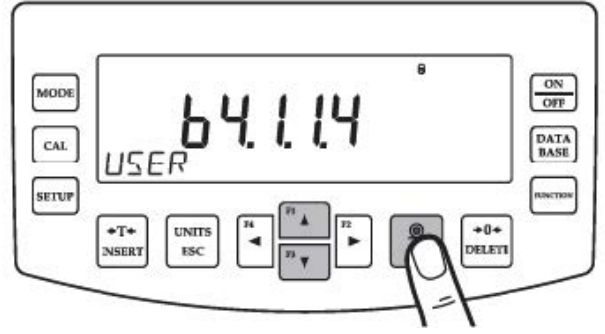

13



Using   keys select permissions level and press  key to confirm.

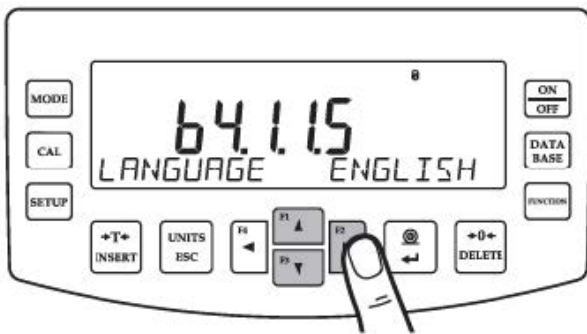

14

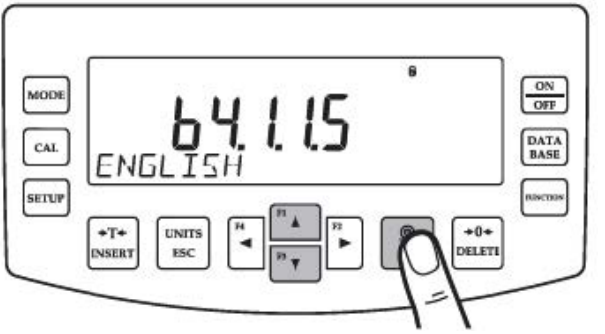

Using   keys select "Language" and press  key to confirm

15



Using   keys to select menu language press  key to confirm.

10. PERIPHERAL DEVICES CONNECTORS

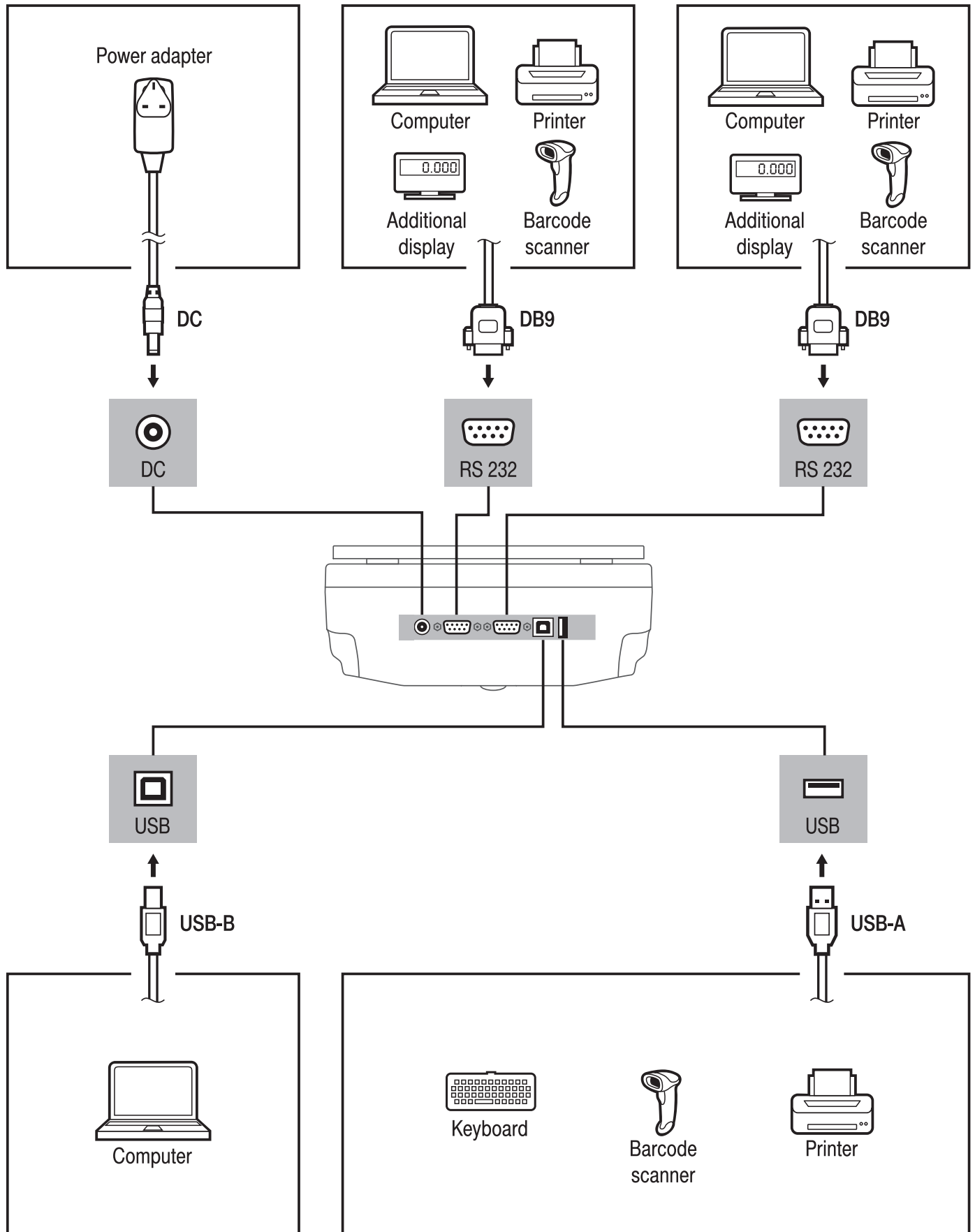

11. DEVICE CLEANING

11.1. General Recommendations

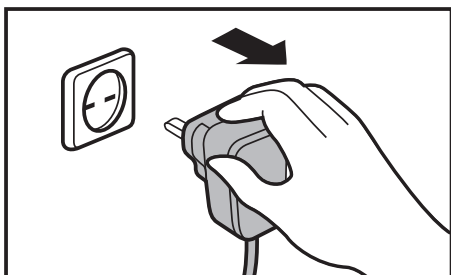

Prior to cleaning it is necessary to disconnect the device from the mains. Remove the plug from the outlet, disconnect all cables

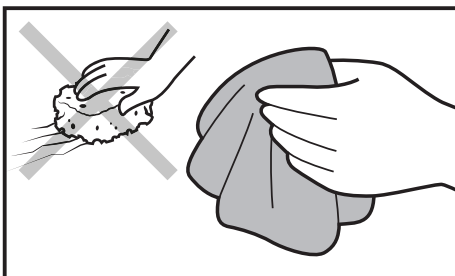

Use soft cloth made of either natural or synthetic fiber exclusively. Avoid using cloth made of stiff/hard fabric, this could cause scratches on the surface.

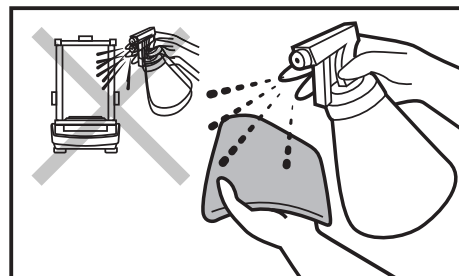

Apply the cleaner onto the cloth. Mind not to apply the cleaner directly onto the device.



Do not use aggressive cleaning agents (e.g. solvents, chlorine preparations, corrosive chemicals, bleach)



Do not use substances of sharp structure or intended for scrubbing



Make sure that dust nor liquid gets inside the weighing system.

11.2. Cleaning Instructions

GLASS PANES AND COMPONENTS can be cleaned using window cleaner.

WEIGHING PANS AND STAINLESS STEEL OR ALUMINUM COMPONENTS can be cleaned using a cloth slightly soaked in a solution of water and gentle cleanser (e.g. soap or dishwashing liquid)

OPERATION PANEL AND HOUSING can be cleaned using a cloth slightly soaked in a solution of water and gentle cleanser (e.g. soap or dishwashing liquid)

Dry sample leftovers can be removed using either a brush or handheld vacuum cleaner.

Clean components can be dried using a soft cloth or dust-free paper towel, with this the remaining moisture will be absorbed.

Install all the components only when they are completely dry.

11.3. Weighing chamber elements disassembly



Prior to disassembling the weighing chamber, make sure the balance is turned off and unplugged from the mains.

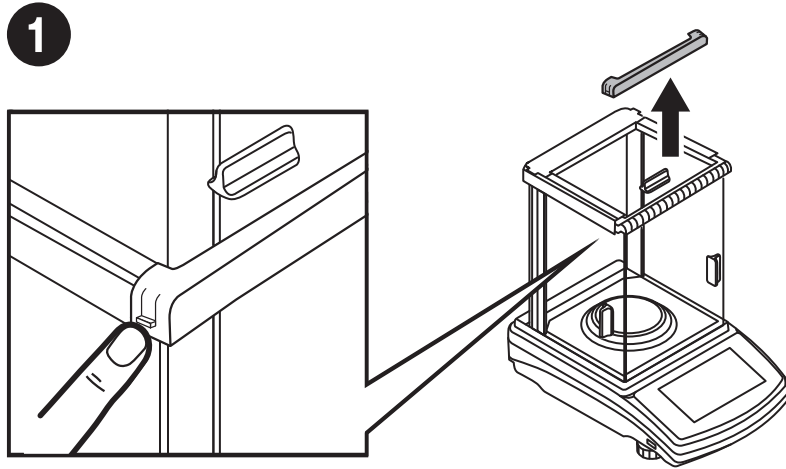

Press the moldings on the housing and lift the movable element up.

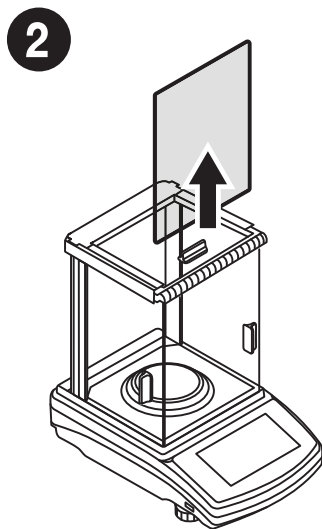

Now you can remove the front glass

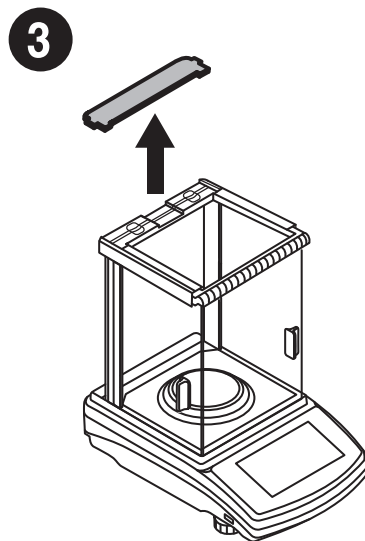

Press the moldings on the housing and lift the movable element up.

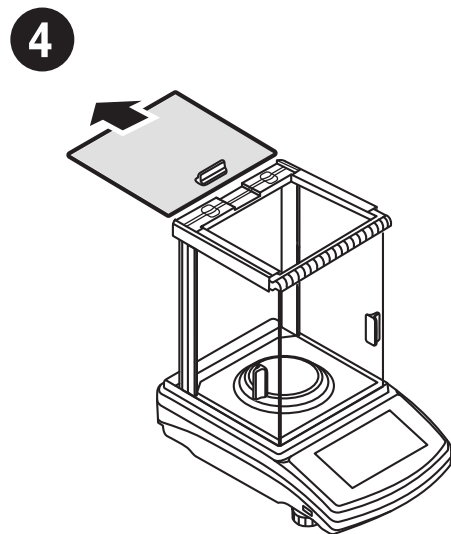

Now you can remove the upper glass

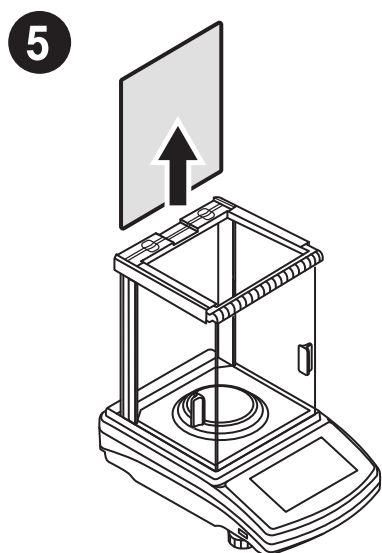

Remove the back glass. The housing has recesses to facilitate removing the glass.

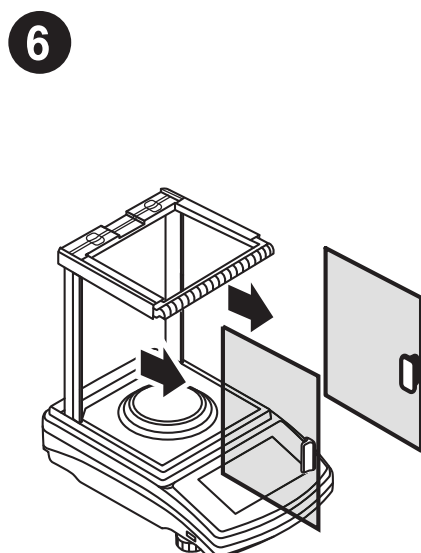

Slide out the doors.



All disassembled elements are prepared to be cleaned. To reassemble draft shield, follow directions in reverse order.