

Corning® CoolBox™ Ice-free Systems

Corning CoolBox ice-free systems are bench-top cooling workstations that provide sample cooling or freezing without ice, electricity, or batteries.

CoolBox systems feature a reusable internal cartridge that provides hours of 0.5°C to 4.0°C cooling or -20°C to 0°C freezing.

CoolBox systems are versatile—they accommodate a variety of sample formats and temperatures, including being used with dry ice to create a portable snap-freezing station.



How It Works

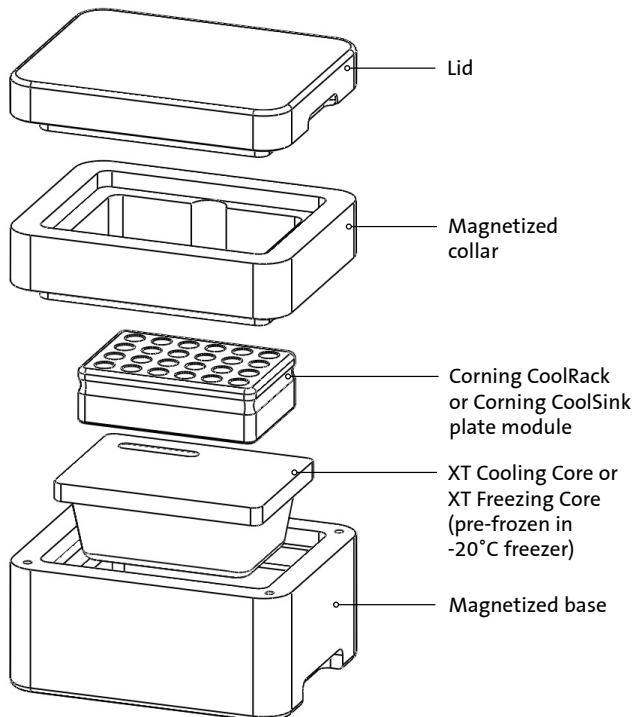

- ▶ Freeze the XT Cooling Core in -20°C freezer
- ▶ Place frozen core in the base
- ▶ Rest the Corning CoolRack® or Corning CoolSink® module on the core (purchase separately)
- ▶ Module will equilibrate and maintain temperature via thermo-conductivity

Corning® CoolBox™ XT Cooling Core Performance

Over 10 hours with lid open, over 16 hours with lid closed

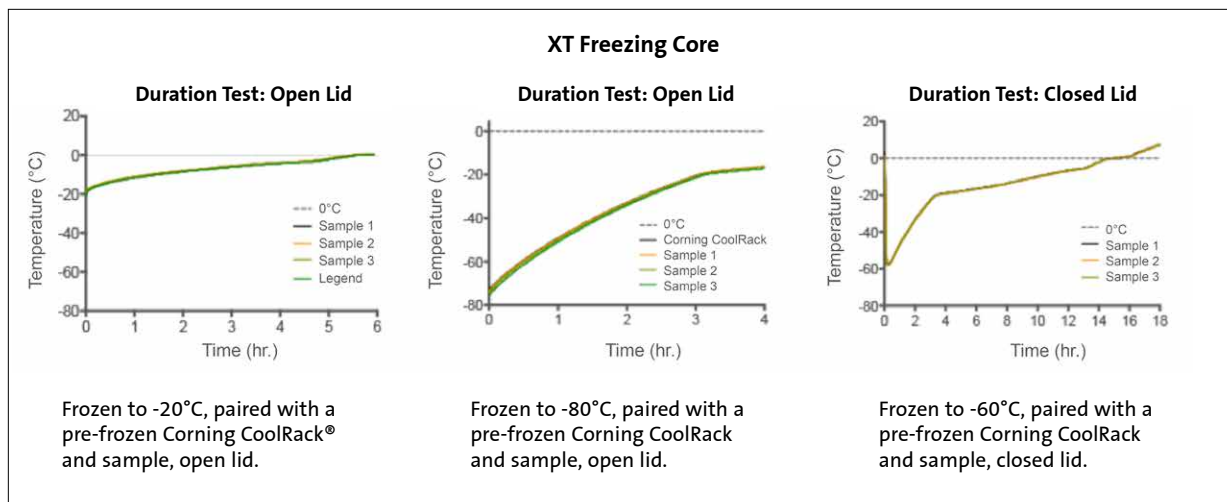
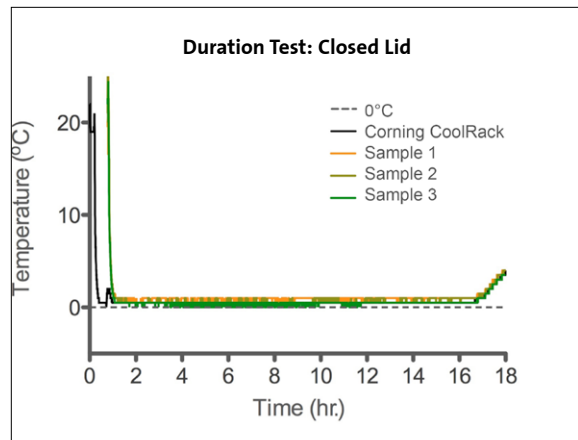
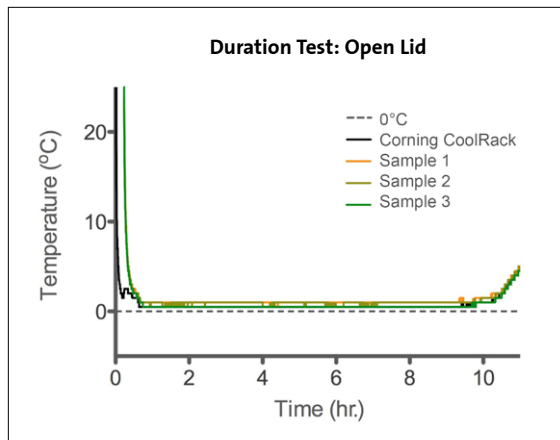

Choose Your Corning CoolBox System



XT Starter











Corning CoolBox XT and 2XT

	XT Starter	Corning CoolBox XT and 2XT
Holds tubes	Yes	Yes
Holds plates	Yes	Yes
0.5°C to 4°C cooling with lid open	4 hours	10 hours
0.5°C to 4°C cooling with lid closed	N/A	16 hours
<0°C freezing with lid open	N/A	5 hours
<0°C freezing with lid closed	N/A	8 hours

Ordering Information

Corning® CoolBox™ Ice-free Systems

Size	External Dimensions	Internal Dimensions	VWR Cat. No. Corning Cat. No.				
			Purple	Lime Green	Orange	Pink	Blue
 XT Starter, complete	16.2 x 12.1 x 6.1 cm	—	75779-828 432014	—	—	—	—
 XT Starter Holder only	16.2 x 12.1 x 6.1 cm	— —	75779-830 432015	—	—	—	—
 XT Cooling Core, 0.5°C to 4°C	— —	— —	—	—	—	—	75779-842 432081
 XT Freezing Core, below 0°C	— —	— —	—	—	—	—	75779-844 432082
 Corning CoolBox XT	20.0 x 16.0 x 15.0 cm	14.0 x 9.4 x 9.9 cm*	75779-852 432021	75779-854 432022	75779-856 432023	75779-858 432024	—
 XT Extension Collar	20.0 x 16.0 x 7.0 cm	14.0 x 9.4 x 7.0 cm	75779-846 432083	75779-786 432084	75779-788 432085	75779-790 432086	—
 Corning CoolBox 2XT	26.5 x 20.0 x 15.0 cm	21.0 x 14.3 x 13.4 cm*	75779-860 432025	75779-862 432026	75779-864 432027	75779-866 432028	—
 2XT Extension Collar	26.5 x 20.0 x 7.0 cm	21.0 x 14.3 x 7.0 cm	75779-792 432087	75779-794 432088	75779-796 432089	75779-798 432090	—

*Internal height of open space when core is in the base.

Corning Cryogenic Vial Grippers

Cryogenic vial grippers feature a unique design to grasp internal or external-thread cryogenic vials. Grippers enable easy sorting and moving of vials while maintaining sterility and protecting fingers from frozen vials, dry ice, and liquid nitrogen.



VWR Cat. No.	Corning Cat. No.	Description
75779-848	432136	Cryogenic vial grippers, multi-color (5/cs)

Contact your VWR Account Representative for a copy of the Corning CoolBox and CoolRack® Consumable Compatibility Guide.

Warranty/Disclaimer: Unless otherwise specified, all products are for research use only. Not intended for use in diagnostic or therapeutic procedures. Corning Life Sciences makes no claims regarding the performance of these products for clinical or diagnostic applications.

CORNING

For additional product or technical information, visit vwr.com/corning, call 1.800.932.5000, or contact your VWR representative.



The banner features the VWR logo on the left, which includes the letters 'VWR' in a stylized blue font with a green swoosh underneath, and the text 'part of avantor' below it. On the right side of the banner, the phone number '800 932 5000' and the website 'VWR.COM' are displayed in white text against a dark blue background. Below the banner, there is a white box containing a disclaimer.

Prices and product details are current when published and subject to change without notice. | Certain products may be limited by federal, state, provincial, or local regulations. | VWR, part of Avantor, makes no claims or warranties concerning sustainable/green products. Any claims concerning sustainable/green products are the sole claims of the manufacturer and not those of VWR International, LLC and/or Avantor, Inc. or affiliates. All prices are in US dollars unless otherwise noted. Offers valid in US and Canada, void where prohibited by law or company policy, while supplies last. | Trademarks are owned by Avantor, Inc. or its affiliates, unless otherwise noted. | Visit vwr.com to view our privacy policy, trademark owners, and additional disclaimers. © 2019 Avantor, Inc. All rights reserved.