

Exterior



Front View

Side View

Top View

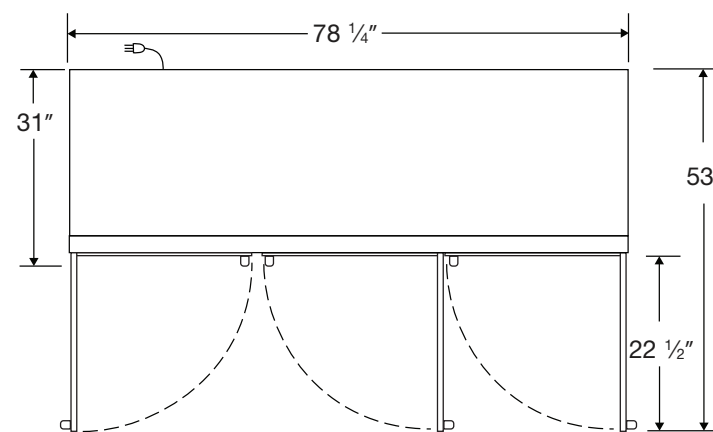
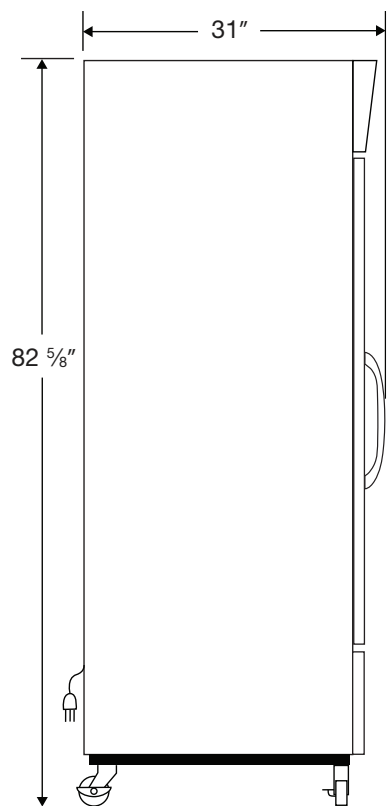
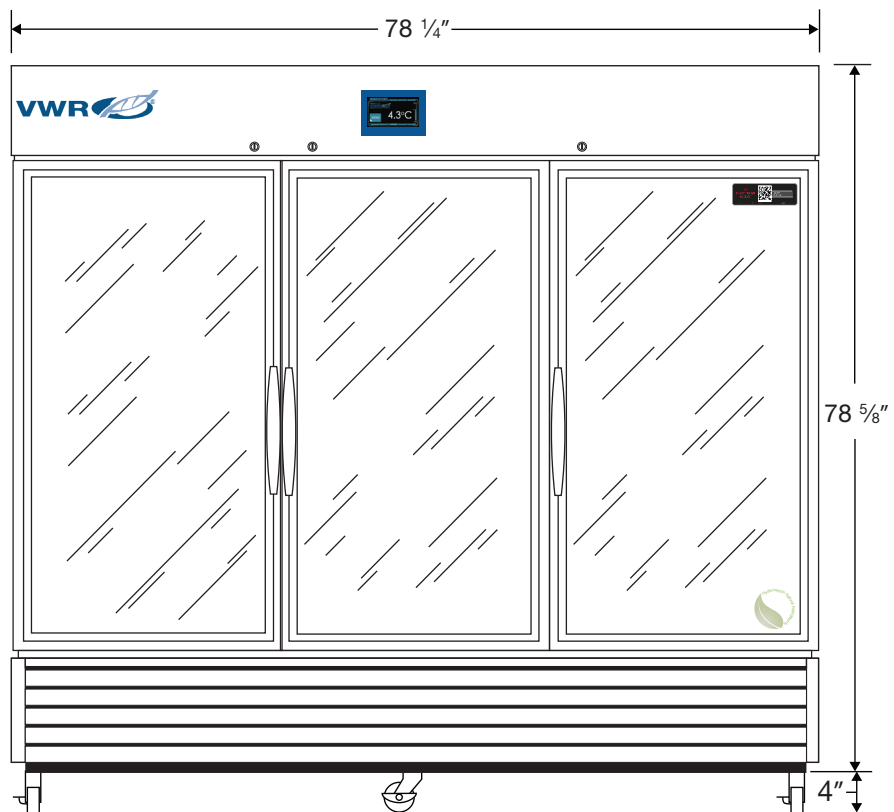
Cat# 76580-166/VWR-HC-72-TS

 115VAC/60Hz/1PH
NEMA-5-15P

Cu.Ft.	Defrost	Door	Int Door	Shelves	W"	D"	H"	Refrigerant	H.P.	Amps	Weight
72	Cycle	3 Glass	0	12 Adj.	78 1/4	31	82 5/8	R290	1/2	8.5	640 lbs.