

BioCLAVE™

Operations Manual

Part Number: 470230-596

For Research Use Only

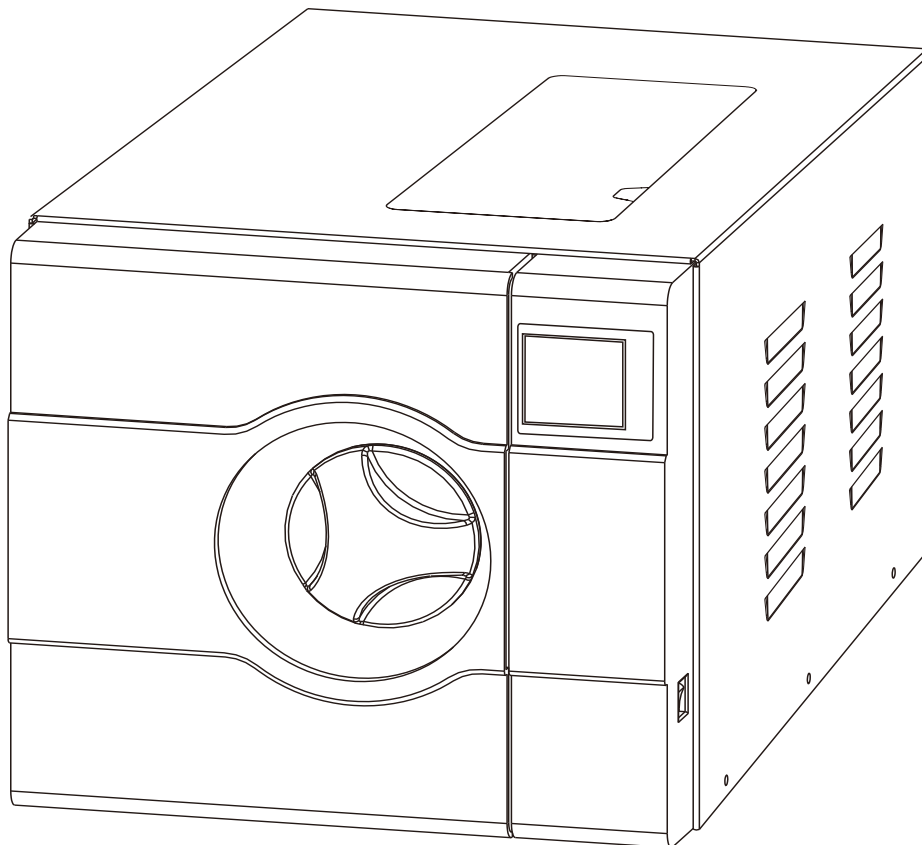

Thank you for choosing our BioClave Benchtop Sterilizer.

Prior to operating this instrument, please read the operations manual carefully and follow all installation instructions.

Need Maintenance

If E88 appears on the screen when power on or appears on the report, please call your dealer or local service maintenance. Your steam sterilizer need a regular maintenance.

TABLE OF CONTENTS

1. GENERAL	1
2. TECHNICAL SPECIFICATIONS	2
3. PACKING CONTENT	2
4. INSTALLATION	3
5. OPERATION	3
5.1 SETUP	3
5.2 PREPARATION OF STERILIZATION MATERIALS	4
5.3 SELECTING THE STERILIZATION PROGRAM	4
5.4 RUNNING THE STERILIZATION PROGRAM	5
6. ADVANCED SETTINGS	6
7. MAINTENANCE	9
8. ERROR CODES	11
9. TRANSPORTATION AND STORAGE	12
10. SAFETY DEVICES	12



APPENDIX

1. WATER PROPERTIES/CHARACTERISTICS	13
2. DIAGRAMS OF THE STERILIZATION PROGRAMS	14
3. WIRING DIAGRAM	16
4. HYDRAULIC DIAGRAM	17

1 General

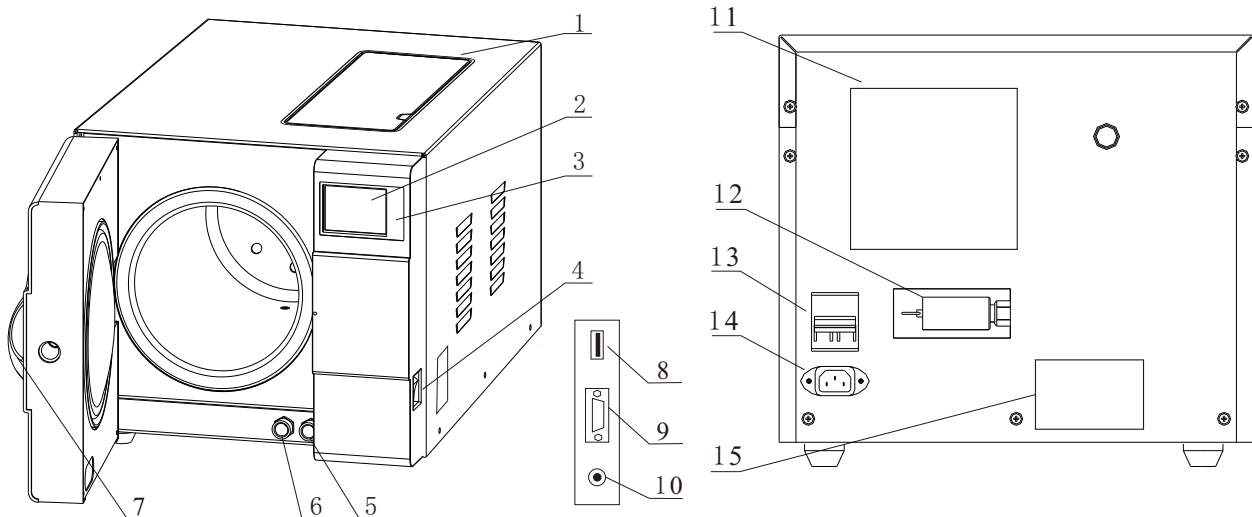
The sterilizer described in this manual is intended for the sterilization of research tools. It operates automatically with 134°C and 121°C sterilization temperatures. This sterilizer is in compliance with the European Directive 93/42/CEE and it has been produced in accordance with the EN 13060. In addition the chamber has been ASME certified.



- 1 Distilled water tank
- 2 LCD screen
- 3 Control panel
- 4 Main Power switch
- 5 Drain connector of distilled water tank 
- 6 Drain connector of used water tank 
- 7 Door handle

- 8 USB port (optional)
- 9 Printer port
- 10 Printer power
- 11 Condenser ventilation
- 12 Safety valve
- 13 Circuit breaker
- 14 Power socket
- 15 Rating plate

Security Notice

For safe operation, please pay close attention to the alert symbols below which can be found throughout this manual. Please carefully read and understand the contents of this manual prior to operating this instrument.



This symbol represents an electrical caution - ground protection



HOT SURFACE.

This symbol represents a warning of a potential hot surface.



Important safety information.

This symbol represents a warning for extra caution

2 Technical Specifications

Item	Parameter
Chamber	Φ170mmX320mm
Rated Voltage	110V AC, 60Hz
Main Fuses	F20A/250V
Nominal power	1600VA
Sterilization Temperature	121°C /134°C
Capacity of the distilled water tank	Approx 2.5L (water at level MAX)
	Approx 0.5L (water at level MIN)
Operation temperature	5 - 40°C
Exterior Dimensions	370mm(width)X 340mm(height)X 570mm(depth)
Weight	66 lb
Noise Level	<70dB
Relative Humidity	max. 80%, non condensing
Atmospheric pressure	11.0psi-15.4psi

3 Packing Content

No.	Item	Quantity
1	Steam sterilizer	1
2	Instrument tray	2
3	Instrument tray rack	1
4	Instrument tray handle	1
5	Door adjustment tool	1
6	Draining hose	2
7	Instructions manual	1
8	Door seal	1

4 Installation

Ensure that the sterilizer is installed with 2.5in. (10cm) ventilation space on all sides of the sterilizer, and 5 in. (20cm) on top side. The clearance required to open the door is 15.5in. (40cm).

The sterilizer should be placed on a level worktable.

Do not cover or block the door, ventilation or radiation openings on the sterilizer.

Do not install the sterilizer near a sink or in a location where it is likely to be splashed.

Do not install the sterilizer nearby a heat source.

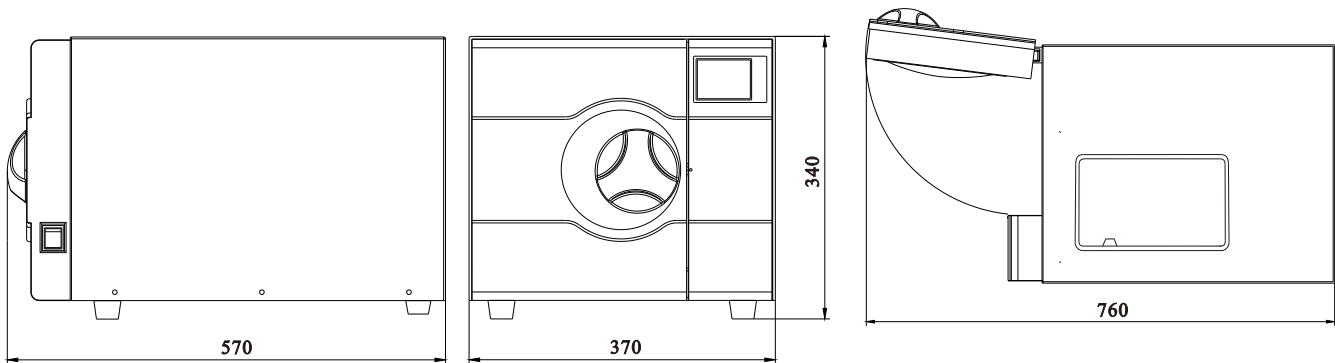

5 Operation

5.1 Setup

5.1.1 Open the door and remove all of the inner contents for unpacking.

5.1.2 Connect the power cord to an outlet of the appropriate voltage

5.1.3 Power on

Switch on the circuit breaker on the back.

The main power switch is located at the right side of the control panel.

After switching on, the machine turns on the LCD

and shows the door position, water level,

working program, date, time and etc.

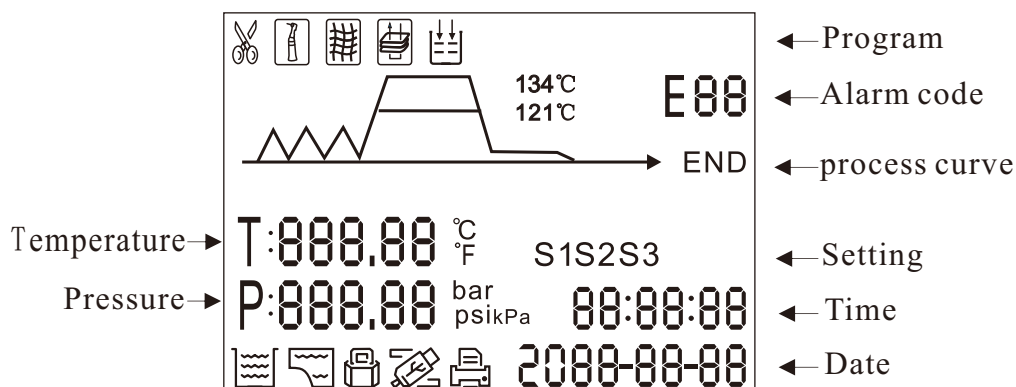
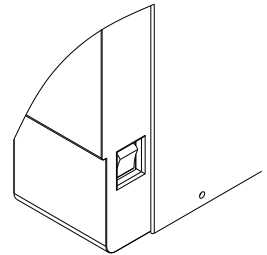

 Distilled water tank is requires water.

 Distilled water tank is full

 Used water tank is full.

 Door locked

 information output to USB port

 Printer is connected

Notice: Before using the sterilizer or at any time the low water icon  blinks, it is necessary to fill the distilled water tank with distilled water.

5.1.4 Filling the distilled water

Open the cover, and fill the tank with distilled water.

When you hear a beep signal, it means the water level exceeds the max. level. The  will be displayed. Please stop filling immediately.

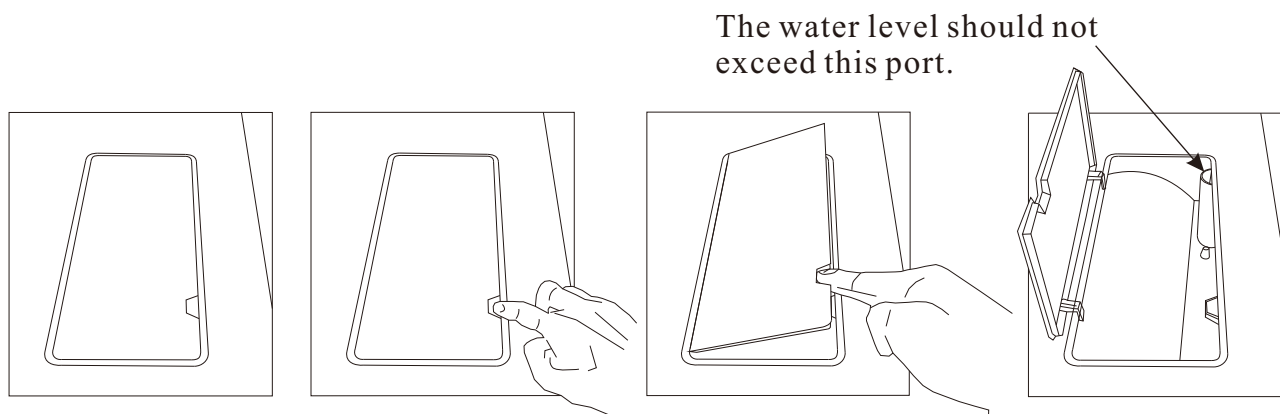

5.2 Preparation of sterilization materials

For the most effective sterilization and to preserve the sample, please follow below:

- * Arrange the samples of different material on different trays or with at least 2in. of space between them.
- * Always insert a sterilization paper or cloth between the tray and sample, to avoid direct contact between the different materials.

5.3 Selecting the sterilization program

5.3.1 LCD

The panel displays the cycle temperature, pressure, error code, sterilization state and program.

5.3.2 **Temp.** Temperature button

Press this button to toggle between 121°C and 134°C





5.3.3 **Prog.** Program button

Press this button to toggle between available sterilization cycles (see below)

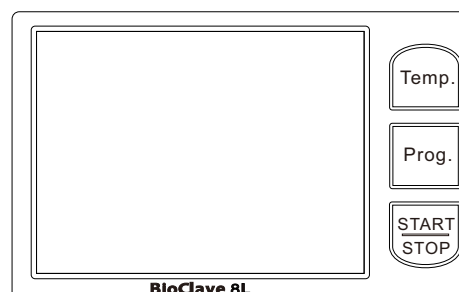
5.3.4 **START/STOP** button

Press this button to start the sterilization cycle. To stop a cycle, press and hold this button for 3 seconds.



-  UNWRAPPED (SOLID)
-  WRAPPED
-  DRYING
-  EXTENSIVE (PRION)
-  LIQUID

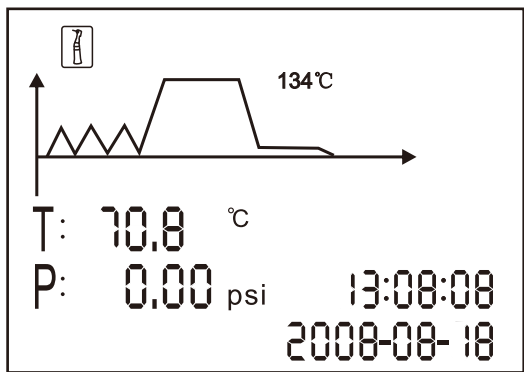

Notice: Button will be “locked” for the initial 10 seconds after power up for system initialization.

5.4 Running the sterilization program.

After selecting program, the materials to be sterilized can now be placed on the tray and the tray placed inside the chamber using the tray handle .

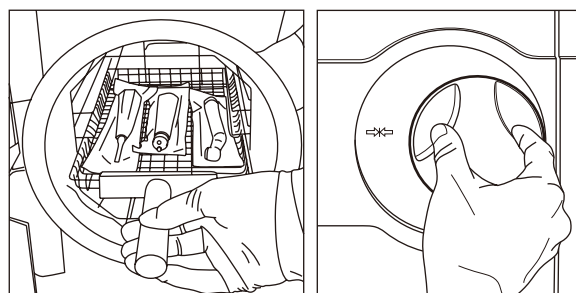

5.4.1 After the instruments are loaded, you may close and lock the door by turning the door handle clockwise until it stops.

The icon  will be lightened.

 **Caution:** You must turn the door handle to the maximum position, otherwise the machine will alarm and prevent completing the cycle.

5.4.2 Start the sterilization program.

Press START button, the machine will begin the cycle automatically.

It will take 30-75 minutes. (See Appendix 2)

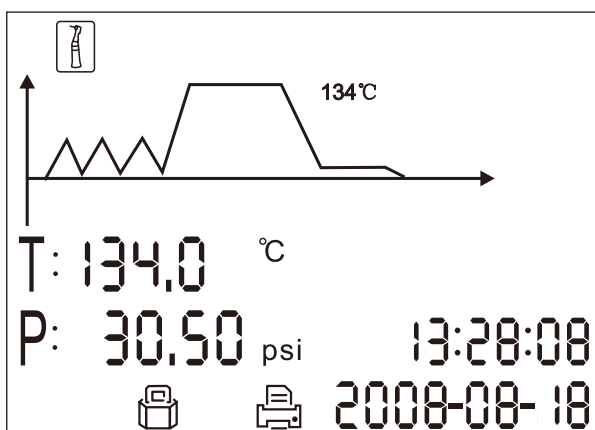

← total time or count down until completion

Caution: When you press the START button but the door has not been fully closed. You will see the  blinking on the screen. A cycle can not be started until you close the door to the max. position and press the "Start" button again.

5.4.3 Sterilization cycle completion

After a cycle is completed, the printer will be activated and print out a report of the cycle settings (if the optional printer has been connected).

After the pressure returns to 0, the door is unlocked and the materials can be removed.

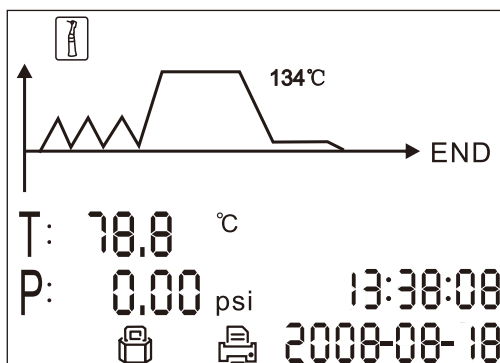

Always use the tray handle to load or unload the tray into the autoclave. Failure to do so can result in burning.

If you need to interrupt a cycle and remove materials urgently, you may hold the START button for 3 seconds after completing sterilization time to skip the dry cycle.

This will result in the program skipping directly to the last step and eliminate the drying stage. After one minute the cycle will end.

6 Advanced Setting

6.1 Enter the setting

6.1.1 Power on the machine while Holding the START button and hold for 5 seconds. This will enter into the advanced settings mode.

6.1.2 Select the state (State 1 thru. 3) by pressing the program button. Press the START button to enter the setting.

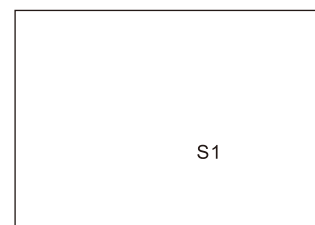

6.2 S1 state

If you select the S1. You may change the unit of temperature and pressure, and adjust time and date.

6.2.1 The first option is to select the unit of temperature. Press temperature button to select °C or °F.

The unit you selected will be lighted. Press the program button to the next item.

6.2.2 You may select the unit of pressure in the same manner.

6.2.3 Then press program button to the next item to adjust the time and date. After the last word of the date or time is set, then the data is permitted to be saved. If you want to finish the setting you shall press START. It will return to the screen of selecting states.

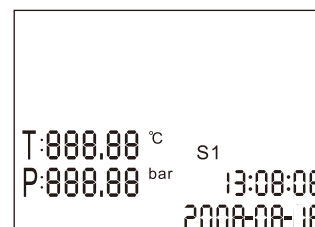

6.3 S2 state

6.3.1 You may check the count of sterilization cycle. It can not be changed by operator.

6.3.2 Set the parameter for high altitude.

If you have trouble completing a cycle in a location of high altitude (above 2.0 km or atmospheric pressure is below 80kPa)

you may need to adjust this parameter.

6.3.3 Language set:

00 English 01 German 02 Spanish 03 Polish
04 French 05 Magyar 06 Romanian 07 Dutch
08 Lithuanian 09 Latvian 10 Czech 11 Italian

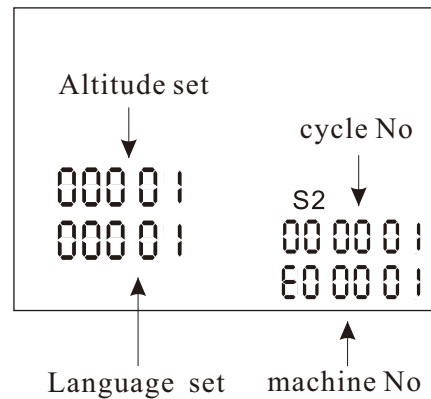

The Machine No. And cycle No can not be set by the operator.

6.4 S3 state

6.4.1 Adjust the length of sterilization and drying time.

Press program button to select the program. ()

Press temperature button to select the temperature of program.

Then press start button to adjust the drying time and holding time.

6.4.2 First to adjust the holding time.

Press temperature button to adjust the data.

Press the program button to select the items.

6.4.3 Press START to save .

6.4.4 Drying time is 0-19.

Holding time of 121 °C is 1-59.

Holding time of 134 °C is 1-19.

holding time →
drying time →

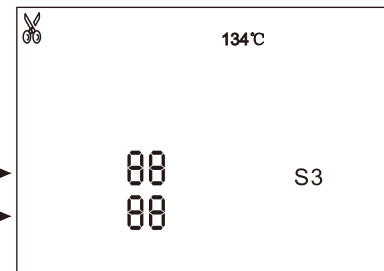

Notice: The default sterilization parameters have been chosen to provide optimal sterilization results. We do not suggest adjusting these parameters unless it is necessary.

6.5 Printer (Optional)

6.5.1 Connect the printer cable.

6.5.2 Connect the printer power.

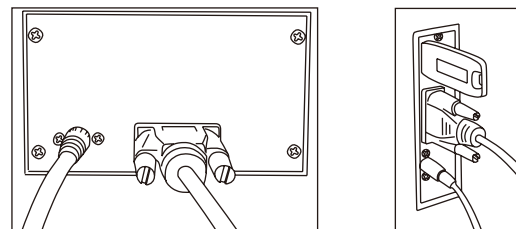

6.6 USB Flash memory (Optional)

A USB drive can be used as a method of storing a report of the cycle. To do so, insert the USB drive to the slot on the right side of the instrument.

The information will automatically output directly to the USB after the cycle has completed. The name of the file is determined by the serial number of the machine and the cycle number.

For example:

The serial number is E00001. The cycle number is 00012.

The file name in the USB stick is 01001200.txt.

The first two numbers represent machine number.

The middle four numbers represent cycle number.

The last two numbers represent error code.

00: no error; 01: error E01

6.7 Retrieve information from a prior cycle

Press program repeatedly until you enter the prior program storage screen. This will show the cycle No.

Press the temperature button to toggle between different cycles.

To print or send details to the USB drive, press the START button. The most recent 20 records are stored.

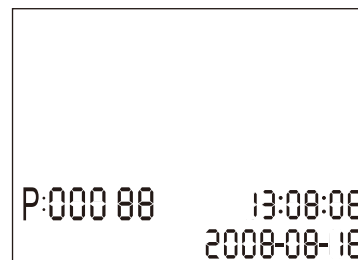

When viewing printed data records, refer to the diagram below:

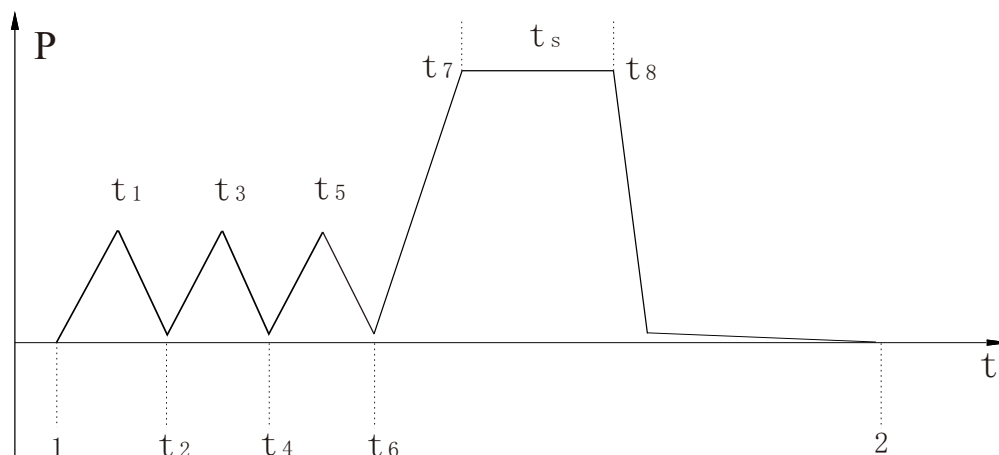

```

=====
Program: WRAPPED
Temperature: 134C
Pressure:30.0 psi
Dry Time: 02Min
Ster Time: 4.0Min
=====

```

```

=====
      time    temp.  pressure
Start 15:24:20 042.0C
T1: 15:32:11 070.0C 07.71psi
T2: 15:36:08 075.3C 01.42psi
T3: 15:39:21 090.3C 07.30psi
T4: 15:44:32 094.3C 01.39psi
T5: 15:47:12 119.0C 14.91psi
T6: 16:00:11 110.2C 01.35psi
TS:          134.8C 32.14psi
Max.Temperature:135.1C
Min.Temperature:134.5C
Max.Pressure:33.42psi
Min.Pressure:30.88psi
T7: 16:04:02 135.0C 32.42psi
T8: 16:06:32 134.8C 31.05psi
End 16:14:12 78.2C
=====

```

```

=====
Cycle No: 0005
Ster Value: Success
Date: 2011-01-18
SN:E00001
Operator:
=====

```

```

=====
Program: WRAPPED
Temperature: 134C
Pressure:30.0 psi
Dry Time: 02Min
Ster Time: 4.0Min
=====

```

```

=====
      time    temp.  pressure
Start 17:34:20 82.0C
T1: 17:42:11 090.0C 07.57psi
T2: 17:46:08 085.3C 01.41psi
T3: 17:49:21 108.3C 07.75psi
T4: 17:54:32 100.3C 01.39psi
T5: 00:00:00 100.3C 000.0psi
T6: 00:00:00 000.0C 000.0psi
TS:          000.0C 000.0psi
MAX.Temperature:000.0 C
MIN.Temperature:000.0 C
MAX.Pressure:000.0psi
MIN.Pressure:000.0psi
T7: 00:00:00 000.0C 000.0psi
T8: 00:00:00 000.0C 000.0psi
End 17:54:42 100.2C 01.46psi
=====

```

```

=====
Cycle No: 0007
Ster Value: Failure E01
Date: 2011-01-18
SN:E00001
Operator:
=====

```

7 Maintenance

Frequency	Maintenance Operation
Daily	Clean the door seal
	Clean the external surface
Weekly	Clean the distilled water tank
	Clean the sterilization chamber
Every month (depending on the use)	Clean the filter inside the chamber and tank
Every year	Replace the door seal

7.1 Clean the distilled water tank every week with isopropyl alcohol or a medical disinfectant.

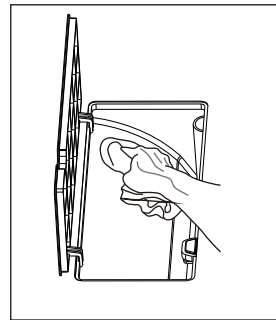

7.2 Clean the chamber weekly.

7.2.1 Remove all trays and the tray rack from the chamber.

7.2.2 Clean the chamber with a smooth cloth saturated with distilled water.

7.2.3 Apply the same procedure for the trays and rack.

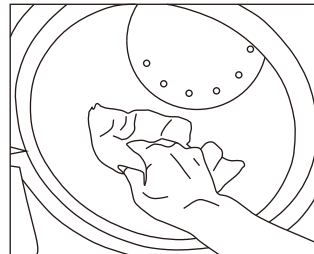

7.3 Clean the door seal

Clean the door seal weekly, with a smooth cloth saturated with the distilled water.

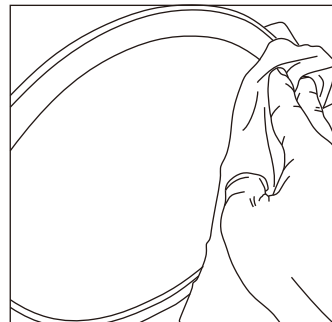
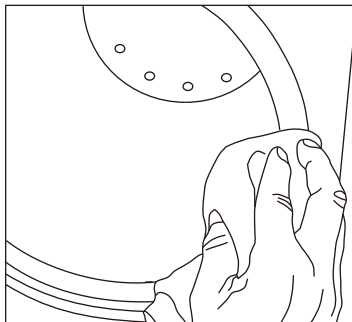

7.4 Door adjustment

On normal circumstance the chamber door does not require adjustments. However, if the seal fails (resulting in steam leaking from the front of the chamber), you may use the included tool to tighten the door seal.

7.4.1 Open the door

7.4.2 Insert the spanner tool in the gap beneath the plastic cover; use the spanner to grip the adjusting nut (Fig 1). Turn the nut counter clockwise as the figure below (Fig 2). This will tighten the sealing plate.

7.4.3 Turn the nut until the sealing plate is tight. If the door knob is too tight, you may also turn the nut clockwise to loosen it.

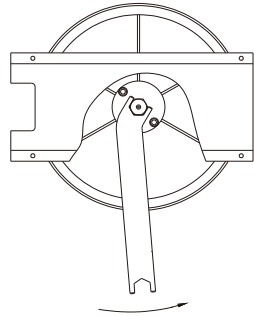

Fig 1

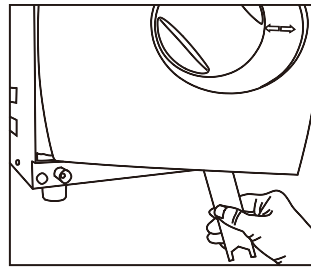

Fig 2

Caution: Never adjust the chamber door while the door is closed.

7.5 Replacement of the door seal

7.5.1 Open the chamber door.

7.5.2 Remove the door seal ring carefully by hand.

7.5.3 Clean the door seal ring carefully with a smooth cloth saturated with distilled water.

7.5.4 Moisten the new seal with medical disinfectant or isopropyl alcohol.

7.5.5 Insert the new seal and press in sequence as follows

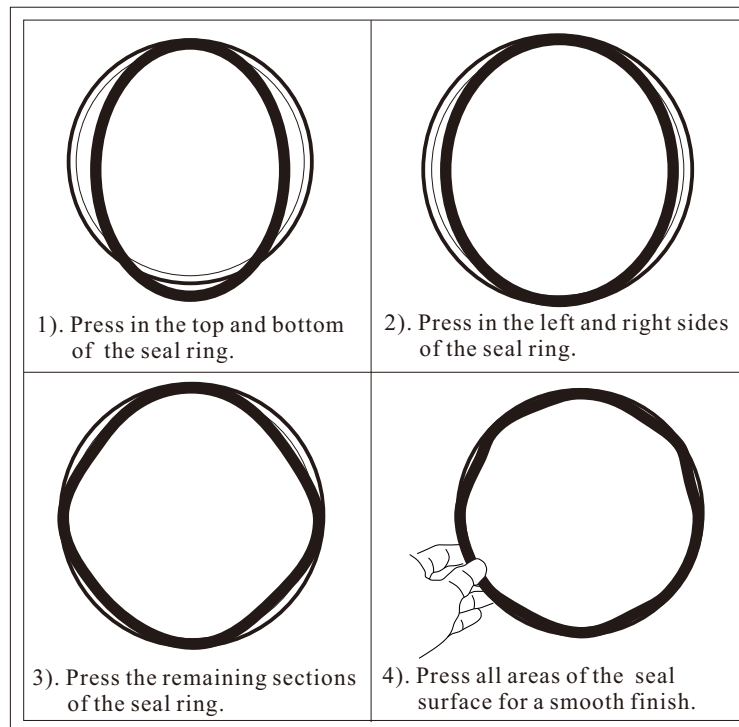

Caution: Please ensure the chamber and the door have cooled prior to replacing the seal ring.

7.6 The drain valve

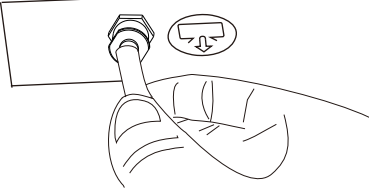
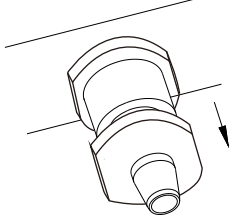
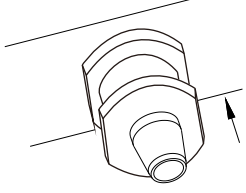
 <p>1. Press the included hose on to the drain valve firmly.</p>	 <p>2. Pull the drain valve outward, the tank will begin to drain.</p>	 <p>3. After finish draining the tank, push the drain valve inward .</p>
---	---	---

8. Error codes

Code	Description	Proposed solution
E1	Steam generator temperature sensor error.	Power off & run a new cycle Contact your supplier if error persist.
E2	Inner temperature sensor error	Power off & run a new cycle Contact your supplier if error persist.
E3	Stemperature sensor of the chamber wall error	Carefully ensure that the chamber wall is heated and contact your supplier.
E4	Fail to rise the temperature	Power off & run a new cycle Contact your supplier if error persist.
E5	Fail to rise the pressure	Power off & run a new cycle Contact your supplier if error persist.
E6	Door lock problem during the cycle	Make sure you have turned the door handle to the max. Position or check the door switch.
E7	The switch of the lock system is disconnected (when autoclave is power on)	Check the door locking switch; Check the solenoid of the door lock; Check the connections of the mainboard.
E9	Failure to hold temperature	Ensure the distilled tank isn't empty. Check the inner temperature sensor. Check somewhere for leaking.
E11	Failure to preheat the steam generator	Power off & run a new cycle Contact your supplier if error persist.
E12	Failure to preheat the chamber	Power off & run a new cycle Contact your supplier if error persist.
E20	Program manually interrupted	Shut off the power and restart the power.
E21	Failure to reach the holding time. (sterilization time)	Check somewhere leaking inside the autoclave.

9. Transportation and storage

- 8.1 Switch off the sterilizer before transportation or storage. Pull out the plug. Let the machine cool down.
- 8.2 Drain the distilled water tank and the used water tank.
- 8.3 Conditions for transportation and storage

Temperature: -20 °C ~ +55 °C.

Relative humidity: ≤ 85%.

Atmospheric pressure: 50 kPa ~ 106 kPa.

10. Safety devices

1. Main fuses: Protection the instrument against possible failures of the heating resistor.
Action: Interruption of the electric power supply.
2. Thermal cutouts on the main transformer windings: Protection against possible short circuit and main transformer primary winding overheating.
Action: Temporary interruption of the winding.
3. Safety valve: Protection against possible sterilization chamber over-pressure.
Action: Release of the steam and restoration of the safety pressure.
4. Safety micro-switch for the door status: Comparison for the correct closing position of the door.
Action: signal of the wrong position of the door.
5. Manually reset thermostat on chamber heating resistors: Protection for possible over heating of the chamber heating resistors.
Action: Interruption of the power supply of the chamber resistors.
6. Manually reset thermostat on steam generator heating resistors: Protection for possible overheating of the steam generator heating resistors.
Action: Interruption of the power supply of the steam generator resistors.
7. Door safety lock: Protection against accidental opening of the door.
Action: Impediment of the accidental opening if the door during the program.
8. Self-leveling hydraulic system: Hydraulic system for the natural pressure leveling in case of manual cycle interruption, alarm or black-out.
Action: Automatic restoration of the atmospheric pressure inside chamber.





APPENDIX 1

Water Properties/Characteristics

DESCRIPTION	FEED WATER	CONDENSATE
Evaporate residue	≥10 mg/l	≥1.0 mg/kg
Silicium oxide SiO_2	≥1 mg/l	≥0.1 mg/kg
Iron	≥0.2 mg/l	≥0.1 mg/kg
Cadmium	≥0.005 mg/l	≥0.05 mg/kg
Lead	≥0.05 mg/l	≥0.1 mg/kg
Rest of heavy metals, excluding iron, cadmium, lead	≥0.1 mg/l	≥0.1 mg/kg
Chloride	≥2 mg/l	≥0.1 mg/l
Phosphates	≥0.5 mg/l	≥0.1 mg/l
Conductivity (at 20°C)	≥15 $\mu\text{s/cm}$	≥3 $\mu\text{s/cm}$
pH value	5–7.5	5–7
Appearance	Colorless, clean, without sediments	Colorless, clean, without sediments
Hardness	≥0.02 mmol/l	≥0.02 mmol/l

APPENDIX 2

DIAGRAMS OF THE STERILIZATION PROGRAMS

PROGRAM	Temperature (°C)	Pressure (psi)	Holding time (min)	Total time (min)	TYPE	Max. Load (kg)	Max. Load per tray (kg)
 UNWRAPPED (SOLID)	134	30.5	4	14-25	Unwrapped solid material	2.00	0.60
	121	16.0	20	25-40			
 LIQUID	134	30.5	10	25-50	Liquid	0.60	0.20
	121	16.0	30	30-55			
 WRAPPED	134	30.5	10	25-45	Unwrapped porous material	1.50	0.60
	121	16.0	20	25-50	Single-wrapped solid or hollow material	2.00	0.60
 EXTENSIVE (PRION)	134	30.5	18	30-50	Unwrapped porous material	0.50	0.15
					Single-wrapped porous material	0.35	0.10
					Dual-wrapped porous material	0.25	0.10
					Single-wrapped hollow material	1.50	0.50
					Dual-wrapped solid and hollow material	1.00	0.30
 DRYING	—	—	—	1-20	—	—	—

**Note: You may adjust the drying time to 0 if you sterilize agar.(refer to 6.4)
It will reduce the risk of boiling.**

The time required for sterilizer to be ready for routine use after the power is switched on less than 5 minutes.

The max. Temperature of the 134°C sterilization cycle is 137 °C

The max. Temperature of the 121°C sterilization cycle is 124 °C

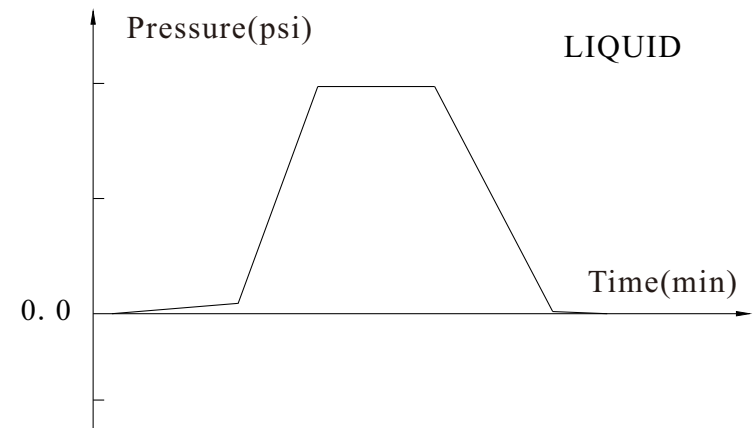
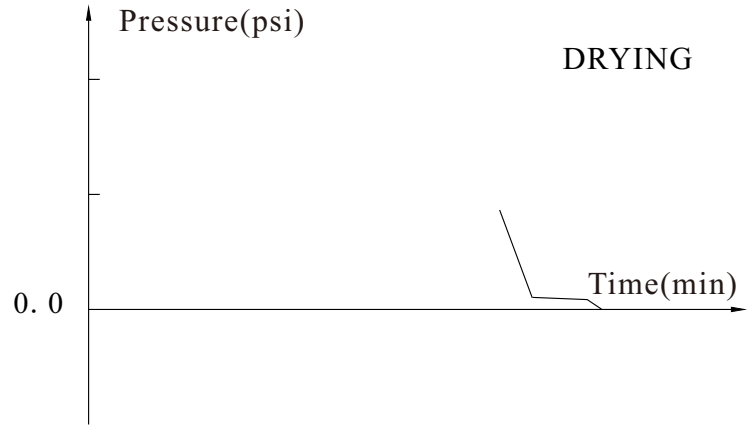
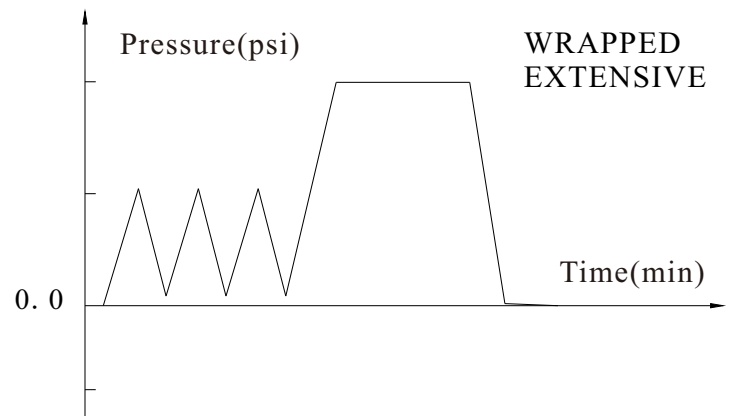
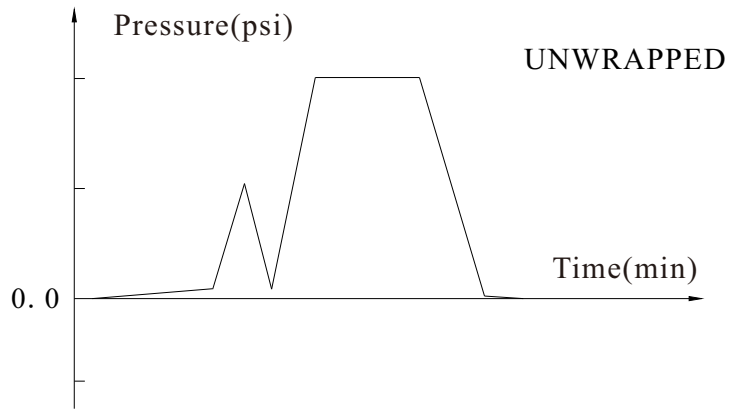

WIRING DIAGRAM

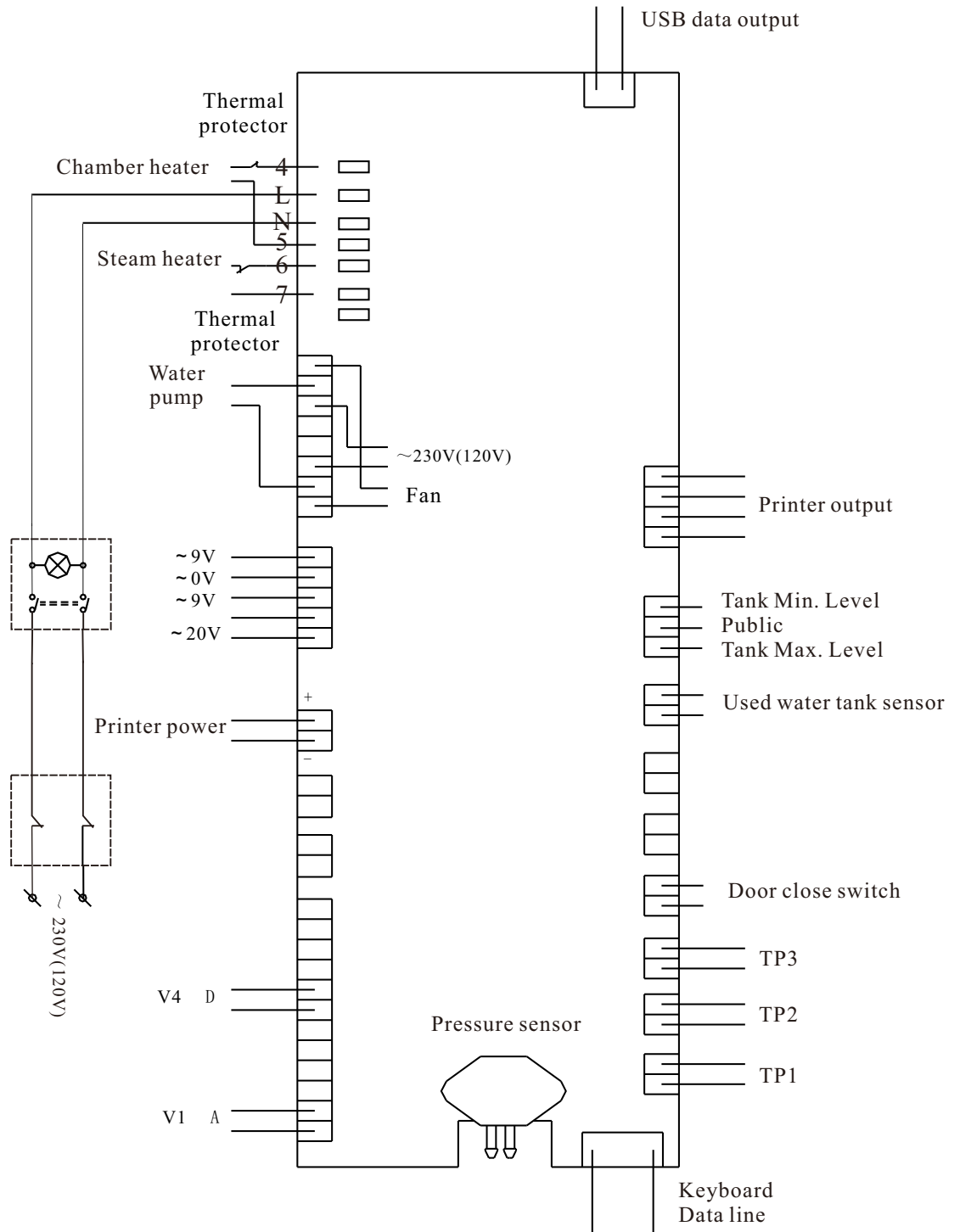

- TP1: Steam generator temperature sensor
- TP2: Inner temperature sensor
- TP3: Temperature sensor of chamber wall
- V1: Air release valve
- V4: Water release valve

HYDRAULIC DIAGRAM

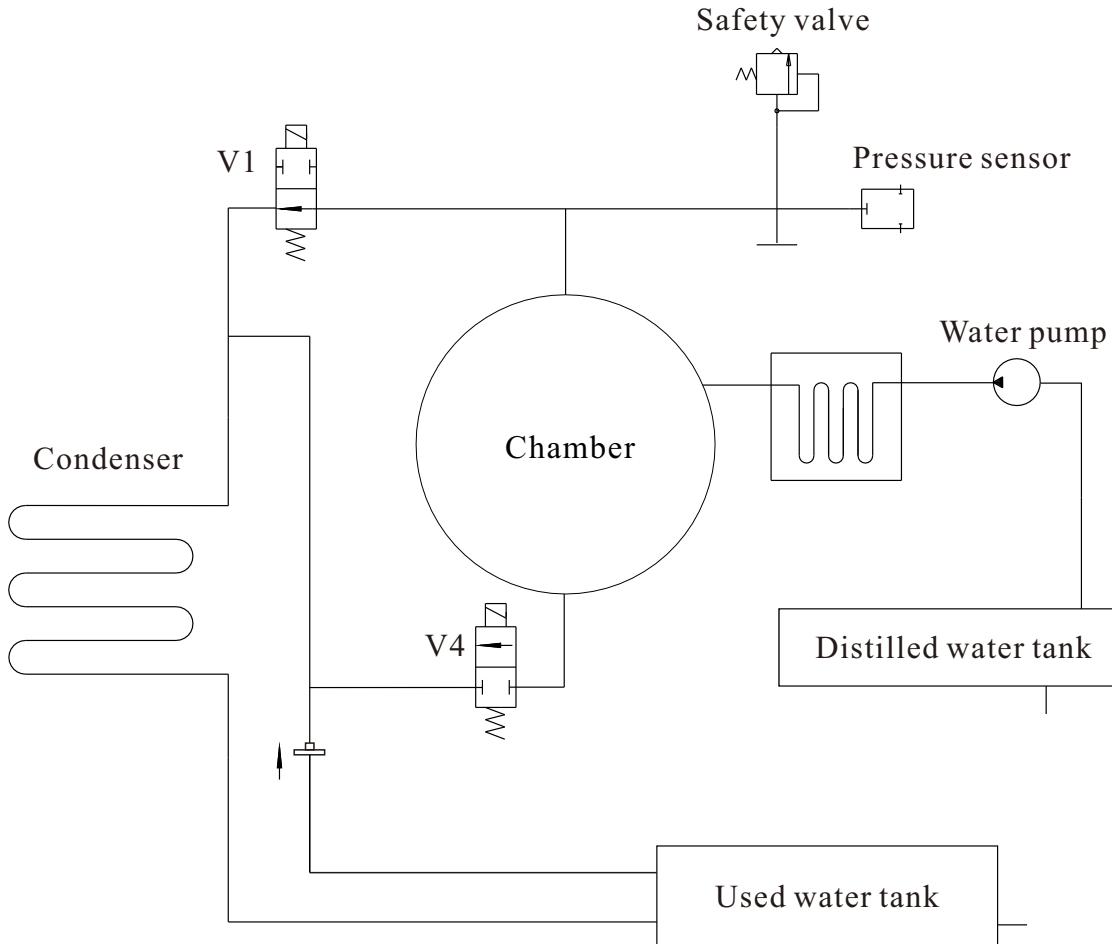

V1: Air release valve
V4: Water release valve