

User Manual of Forced Convection Oven

Model : OVF-800 series
52412Mechanicaloven_ver_1.2



⚠ WARNING

Please read this user manual carefully before using the product. Users should operate the product according to the operating instructions contained in this user manual. Users should be aware of cautions and warnings for your safety. Failure to follow these guidelines may result in serious injury or damage to your property.

Thank you for purchasing Cole-Parmer's products.

Cole-Parmer is committed to offer the customer service including product sales, technical service, and follow-up management. If you have any question about this user manual, please contact our sales department.

Disclaimer

The material in this manual is for the users' information only. The products it describes are subject to change without prior notice, due to the manufacturer's continuous development program.

Copyright

No part of this manual may be reproduced or transmitted in any form or by any means, including photocopying, recording, or using information storage and retrieval systems, for any purpose other than the purchaser's own use, without the express written permission of Cole-Parmer Instrument, LLC.

©2022. Cole-Parmer Instrument Company, LLC.

Third-party product names or brand names mentioned in this user manual may be the trademarks of their respective owners. Cole-Parmer has no connection with those companies and we do not endorse or recommend them directly nor indirectly.

Contents

1.0	Safety.....	6
1.1	How to use and read this user's manual.....	7
1.1.1	Introduction.....	7
1.1.2	Summary of each Chapters.....	7
1.1.3	The Product Model of the Instrument.....	7
1.2	Responsibility.....	8
1.2.1	General Responsibility.....	8
1.2.2	User's Responsibility.....	8
1.2.3	Responsibility for maintenance.....	9
1.3	The Indications Used in this User Manual.....	10
1.3.1	Signal Word Panels.....	10
1.3.2	Safety Symbols.....	10
1.4	Instructions for safe use (required reading).....	11
1.4.1	Warnings.....	12
1.4.2	Caution.....	14
2.0	Functional Description.....	16
2.1	Introduction.....	17
2.2	Feature.....	17
2.2.1	Excellent Performance.....	17
2.2.2	Safety Enhancement.....	18
2.2.3	Improved Convenience.....	18
2.3	Structure.....	19
3.0	Installation.....	23
3.1	Components of the Instrument.....	24
3.2	Preparations before installation.....	25
3.2.1	Installation Condition.....	25
3.2.2	Installation Guidelines.....	26
3.2.3	Minimum required space for Installation location.....	27
3.2.4	How to install shelf and its support.....	28
3.2.5	Available Space.....	29
3.3	The labels attached to the instrument.....	30
3.4	Power Connection.....	31
3.5	Checklists before the Use.....	32
4.0	Operation.....	34

4.1	Controller Home Screen names and functions.....	35
4.2	Basic Mode.....	36
4.2.1	Start and Stop in the Basic Mode.....	37
4.2.2	Temperature Settings.....	38
4.2.3	Timer Settings and Control.....	39
4.2.4	Checking the Operation after Timer Setting.....	42
4.2.5	Instantaneous Outage Recovery Function.....	43
4.3	General Settings.....	44
4.3.1	Sound & Display.....	44
4.3.2	Clock.....	45
4.3.3	Language.....	46
4.3.4	Event.....	46
4.3.5	Communication.....	47
4.3.6	Auto Run.....	48
4.4	System Settings.....	49
4.4.1	Temperature.....	50
4.4.2	Calibration.....	50
4.4.3	Auto Tuning.....	51
4.4.4	Alarm.....	53
4.4.5	Password.....	54
4.4.6	Factory Default.....	54
4.5	Safety Function.....	55
4.5.1	Safety Functions Related to Temperature.....	55
4.5.2	Safety Functions Related to Use.....	55
4.5.3	Alarm Display and Pop-up Notification Function.....	56
4.6	Over temperature limiter.....	57
5.0	Maintenance.....	58
5.1	Inspection Cycle.....	59
5.2	Cleaning the Instrument.....	60
5.2.1	Cleaning the interior part of the instrument.....	60
5.2.2	Cleaning exterior part of the instrument.....	60
5.2.3	Cleaning the accessories.....	61
5.3	Major maintenance checks.....	61
5.4	Movement and storage.....	62
6.0	Trouble Shooting.....	63
6.1	Trouble Shootings for abnormalities.....	64
6.2	Power Trouble Shootings for abnormalities.....	64
6.3	Error Handlings.....	65

6.4	Caution and warning alarms.....	66
6.4.1	Caution.....	66
6.4.2	Warning	66
7.0	Accessories	67
7.1	Types of Accessories.....	68
8.0	Appendix.....	69
8.1	Technical Specification.....	70
8.1.1	OVF-800 Series	70
8.2	Disposal of Product	71
8.3	Warranty.....	71
8.3.1	Warranty period.....	71
8.3.2	Warranty Exception	71
8.3.3	How to Request for the Customer Service	72
8.3.4	Returning Process of the Product	72
8.4	Contact Points	73

1.0 Safety

1.1 How to use and read this user's manual

1.1.1 Introduction

This user's manual is published for the force convection oven users. This manual contains the contents of the oven's installation, operation, and maintenance.

This manual can be used as a reference for the safe use of the instrument and its simple repair. Please do not repair the instrument without a technical support of our company.
 Never move the instrument without a help of technical expert of the laboratory devices and electronics.
 Make sure to keep the user manual after use.

1.1.2 Summary of each Chapters

The chapter 1 provides safety information about the safe use of the instrument. Please make sure to read it before installation and operation.

The chapter 2 provides functional description about the introduction, features, and structure of the instrument.

The chapter 3 contains installation instructions for instrument confirmation and installation. Also, it describes preparation procedures before operation and installation.

The chapter 4 describes operation of the instrument including names and functions of the control panel and basic operating functions of the instrument.

The chapter 5 provides information of maintenance including cleaning, moving, and storing instrument.

The chapter 6 provides information troubleshooting for the event of abnormality that may occur during use of the instrument.

The chapter 7 lists accessories of the instrument and how to mount it.

The chapter 8 provides Appendix of the instrument including specifications, disposal, warranty, and technical support contacts.

1.1.3 The Product Model of the Instrument

This user manual is applicable to OVF-800 series instrument as listed below.

	Forced Convection Oven Series			
Product Models	52412-15 52412-16	52412-17 52412-18	52412-19 52412-20	52412-21 52412-22

1.2 Responsibility

You can maximize your safety while using the instrument only when you follow the instructions about the instrument operation and maintenance under general operation conditions.

All users must be fully aware of the safety rules described in this user manual and then operate the instrument in the hazard • warning • caution indications.

1.2.1 General Responsibility

Safety is the first priority in any case. The owner, users, and maintenance personnel of the instrument should be fully aware that safety is the most important part of their work.

If you are concerned about damage in terms of efficiency, please consider the impact of human and material damage on productivity occurred by safety insensitivity accidents. The most reliable way to increase efficiency and productivity is to establish effective safety programs and comply with safety rules.

In addition to maintaining and repairing the instrument regularly, please check the condition of the instrument every day to ensure the safety. Also, please be sure to be familiar with this user manual, which describes each function and safety guide for the instrument.

1.2.2 User's Responsibility

One of the most important users' responsibilities is to achieve efficient and productive experimentation. However, those are not the only part of the users' responsibilities. Even though users should be aware of the performance and limitations of the instrument, sometimes the safety of the parties is forgettable due to their desire for efficiency. Safety rules or user manuals do not protect the users from injury while using the instrument.

Therefore, please always follow the safety guidelines to operate the instrument. Also, please report potential risk situations to your superiors and colleagues immediately.

Things to be aware of

- Do not operate or fix the instrument without taking proper training or fully familiarizing yourself with the user manual.
- Please check the power voltage, phase, and capacity indicated on the ID label, and then connect it correctly.
- Do not touch hands or parts of your body to any part of the instrument that may cause injury.
- When operating the instrument, be careful not to wear loose clothes or accessories. If you have long hair, please tie your hair or wear a hair cap for your safety.
- When the instrument is not in use, please turn off the power switch or unplug the power cord.
- If the instrument does not work normally or has been left unattended for a long time, please check all the settings before operating the instrument.
- If you need to move the instrument or use it after a long pause, make sure that the instrument is operating normally.
- Please stop using the instrument when it appears with the following status, please stop the operation immediately and report it to the middle manager.
 - Incomplete operation or condition
 - Short circuit
 - Inappropriate maintenance

1.2.3 Responsibility for maintenance

Proper maintenance is one of the most important part of your responsibilities for your safety. Maintenance personnel must be aware of the importance of the safety in order to maintain the instrument effectively.

Please cut off all the electrical supply when you need to remove, adjust, or replace parts of the instrument. Also, please mark the instrument with a warning sign, "working."

Please make sure that it is correctly connected to a grounded outlet that fits to this instruments' plug.





Do not operate the instrument until all workers clean the surroundings. Also, before the operation, please check if there is any abnormality of the functions.

1.3 The Indications Used in this User Manual

This user manual uses signal word panels, safety symbols, and non-safety symbols to prevent accidents or damage in advance. Before using the instrument, please be sure to be familiar with the following indications.







1.3.1 Signal Word Panels











Signal Word Panels are indications to inform users about accidents, damage, and risk levels. Safety signs consists of three individual components: safety warning signs, phrases, and specific colors complied with ANSIZ535.4-2007 and ISO 3864.

Safety Word Panels	Contents
	Indicates a hazardous situation which, if not avoided, will result in death, fatal injury, or property damage
	Indicates a hazardous situation which, if not avoided, could result in serious injury, or property damage
	Indicates a hazardous situation which, if not avoided, may result in minor injury or property damage.
	Notifies you careful actions that are not relevant to your injury

1.3.2 Safety Symbols





Safety symbols are visual symbols that nonverbally convey hazardous situations, risk prevention methods, consequences of hazardous situations, or combinations thereof. Please operate the product with caution to the following safety signs.

Mandatory			
	Read the manual.		Wear gloves.
	Wear a face mask.		Wear eye protection.
Prohibition			
	Avoid direct sunlight		Avoid high frequency noise

	Beware of corrosive fluids or cleaners		Avoid water
Warning			
	Safety alert symbol For general cautions		Beware of electrical shock
	Beware of flammable or fire.		Do not place combustible dust inside.
	Do not insert toxic chemical inside.		Do not take the device apart deliberately.
	Beware of hand crush or pinch.		Beware of foot crush.
	Beware of lifting hazards.		

1.3.3 Non-safety Symbols

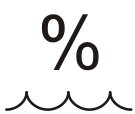
The graphics below are used to convey important information about the use and characteristics of the instrument without further explanation.

Non-safety Symbols			
	Permissible ambient temperature		Altitude
	Relative humidity		Earth ground

1.4 Instructions for safe use (required reading)

This instrument has been manufactured reliably and stably only when the operators follow this user manual's instructions of installation, operation, and maintenance. Before you install or operate the instrument, please be aware of this user manual's instructions and safety precautions. If you have any

questions or comments regarding to this user manual or the instrument, please contact our Cole-Parmer sales department.

To prevent personal injury or damage to the instrument during the installation, operation, or maintenance, please be fully aware of the warnings and cautions shown below.

1.4.1 Warnings



1) Safety Labels

- Please be fully aware of all the safety labels.
- Do not remove or damage the attached safety labels.

2) Electricity and Power

- Before installing the instrument, you should check the power voltage, phase, and capacity displayed on the ID label and connect them correctly.
- This instrument needs to use a power with high resistance grounding.
- : If the power is not grounded or poorly grounded, it may cause a hazard risk to an operator or the instrument. Also, never ground in a gas or water pipe.
- Do not connect other devices at the same time with one outlet.
- Never use branch sockets or double taps.
- : Over current can cause severe damage to cables, damage to instrument, and fire.
Do not operate the instrument when the power line is damaged.
- Improper power connections can cause damage to the instrument and serious personal injury or death.
Do not handle or touch the electrical cords or electrical components with wet hands.

3) Installation

- Avoid contact with toxic chemical to the inside of the instrument.
- Do NOT install the instrument where flammable gas may leak.
- Do NOT use or store combustible gas around the instrument.
- Do NOT operate the instrument where an explosion may be occurred by organic evaporation gas.
- Do NOT operate the instrument in presence of industrial harmful gas, exhaust gas, or metal dust.
- Do NOT install instrument around gas pipes or water pipes.
- Do NOT install instrument in places with high humidity or risk of leakage.
- Water and organic solvents in the control panel may cause electrical short circuits.
- Do NOT expose the instrument to direct heat sources or direct sunlight.
- Keep the ambient temperature of the instrument between 5 and 40°C and the relative humidity below 80%.
- Ensure that the height of the installation site is less than 2,000 meters above the sea level.
- Install the instrument on a solid and flat floor in a laboratory facilitated with safety equipment.
- The door opens up to 115° to the left, so sufficient space should be considered when installing the instrument.

4) Operating and Transfer Instructions

- Do NOT place explosive, flammable, combustible or oxidizable chemicals such as alcohol, benzene,

gasoline, etc. on top of the instrument, store them or operate them inside the oven. There is a risk of fire, since the instrument is not an explosion proof structure.

- Do NOT place liquid containers on the instrument. Leakage of liquid may cause damage to the instrument.
- Do NOT allow moisture, organic solvents, dust, and corrosive gases into the operating parts and inside of the instrument.
- Do NOT use the instrument if it makes strange sounds, smells or smoke.
- Do NOT operate damaged or short-circuit equipment.
- Do NOT move the instrument when the power cord is connected or when the instrument is operating.

5) Repair and Modification

- Do NOT disassemble or modify the instrument at any time other than those described in this user manual.
- When handling electrical components inside the instrument, only qualified personnel should handle them.



Avoid direct sunlight.



Beware of corrosive materials.



Avoid water.



Beware of electrical shocks.



Beware of fire.



Avoid contact with toxic chemical to the inside of the instrument.



Do not disassemble deliberately.



Do not put flammable dust inside the device.

1.4.2 Caution

CAUTION

Indicates a hazardous situation which, if not avoided, may result in minor injury or property damage.

1) Power

- This instrument should use a grounded power cord
- When installing and using the product, always use a grounded power outlet.
- Plug the power tightly and correctly to prevent loosening from the outlet.
- Avoid heavy objects or the instrument to be placed on the power cord.
- When the instrument is not in use, be sure to turn off the main power switch before unplugging the power cord.

2) Installation

- Do NOT install the instrument near devices with strong and high frequency noise (high frequency welders, high frequency sewing machines, high-capacity SCR controls).
- Be aware that artificial heart pulses or magnetic data devices may be affected by magnetic bars of the oven.
- Do NOT install instruments adjacent to other experimental devices, electrical devices and power terminals.
- Do NOT install the instrument in unventilated corners. If the place is not sufficiently ventilated, there is a risk of damage to the instrument due to overheating by difficult heat dissipation.
- The device should be installed close to the outlet and should be easy to use.
- Maintain an appropriate clearance distance (typically at least 30 cm) from other instruments.

3) Machine Operation

- When initiating the instrument, the operator should check the machine continuously until it reaches to normal status.
- Wear gloves when handling samples to prevent burns since there may be residual heat during the operation or even when the power is off.
- Keep the instrument clean and make sure that there is no any foreign substances inside the chamber.
- Take a special care not to damage any accessories or systems inside the instrument.
- Be careful not to contact the main body with high concentrations of nitric acid, sulfuric acid, sodium hydroxide, or corrosive solvents such as acetone, benzene, phenol, toluene, chloroform, crezol, acetic acid, chlorate.
- If the instrument is wet, shut down the machine immediately, remove the power cord, and request for the technical service.
- Do not insert conductive or flammable objects into the air ducts formed inside or outside the instrument. There is a risk of fire or electric shock.
- Do not give a shock or vibrate the instrument.
- Avoid contact with pesticides or combustible gases.

4) Storage and Transfer

- Be careful when transporting the instrument since it is heavy. Use required and appropriate tools when transporting the instrument, two or more people should carry it together.
- Do not move the instrument with the door holding.
- Do not cause mechanical shock or vibration during the transportation and storage of the instrument. Internal damage may cause problems with operation.
- Disconnect the power plug when the instrument is not in use.

5) Cleaning

- Before cleaning, turn off the power switch and remove the plug from the outlet. There is a risk of electric shock.
- Also, wear chemical resistant gloves.
- Never use chlorine detergent. It may cause the chamber to be oxidized. Also, do not use volatile substances such as cleaning agents, abrasives, benzene, acids or solvents.
- Do not use organic solvents such as sulfuric acid or hydrochloric acid to wipe the surface of the instrument.
- Use a soft cloth or sponge with a neutral detergent to clean the cleaning tool.
- Do not pour water directly into the instrument while cleaning the instrument or its surroundings.
- Do not disassemble when cleaning the instrument.
- If you are cleaning the instrument in a way other than the above, please check the cleaning manner with Cole-Parmer.

6) Repair

- The electric parts and circuits embedded in this instrument are developed by Cole-Parmer, therefore no one, who is not Cole-Parmer employee or delegated person, should never fix this instrument.



Avoid high frequency.



Avoid water.



Beware of electric shock.



Beware of heavy weight.



Beware of fire.



Wear gloves.

In addition to the above-mentioned safety warnings, safety warnings are mentioned throughout this manual. These safety warnings are described with "warning marks" and "safety warnings". If users do not follow these important instructions, they may cause severe defects or fatal damage to the instrument, may result in personal injury, and death.

2.0 Functional Description

2.1 Introduction

This instrument is a multi-purpose Forced Convection Oven that can be used in a variety of the fields such as biotechnology, pharmaceutical, medical, chemical, and biology. It is a fast-drying instrument that supports an excellent experimental environment of thermal curing and denaturation of samples, preheating of building materials and electronic components, heating removal of food, and experimenting heat resistance.

2.2 Feature

2.2.1 Excellent Performance

(1) Controlling wide range of temperature

It controls up to 250°C. An excellent insulation of the instrument minimizes heat loss inside the chamber.

(2) An excellent temperature uniformity and precision

The internal fan transfers the heat to the samples quickly, evenly, and precisely.

(3) A reliability and reproducibility of temperature

An excellent reliability and reproducibility of temperature distribution has been verified by strict overseas standards, DIN 12880 and IEC 60068-3-5.

(4) An excellent insulation and low heat loss

Mineral wool resin insulation of an external chamber and doors, and high-temperature silicone door packing supports an excellent insulation and low heat loss.

(5) Convenient control

Automatically sets the PID temperature control coefficient suitable for the user's operating environment. [4.4.3 Refers to Auto tuning].

(6) Precise temperature control

A 3-point temperature correction function enables calibration of three temperature points to ensure accuracy in a wide temperature range. [4.4.3 Refers to Calibration]

(7) Automatic event-recording system

It automatically records up to 12 alarms that are occurred while using the device.

2.2.2 Safety Enhancement

(1) Emergency management with a CLS-Control System

The CLS (Custom Logic Safety)-Control System is industry's first implementation that enhanced convenience, safety, and stability specifically in laboratories with various flammable drugs. The CLS system (Patent Registration No. 10-0397583, 10-0328729) immediately cuts off both phases of power completely supplied to various parts of the device, with notifying the user of an unstable operation with a visual and audible manner, and keeps the device powered off until it is manually restarted by an operator. It is developed by its researchers for the safe use of heated devices operated in environments that require perfect thermal safety, such as.

(2) Overcurrent limiter

Safety circuit protect the device from overcurrent and over-heating of the heater.

(3) Over temperature limiter

An embedded mechanical temperature limiter prevents damage from overheating. [4.6. Refers to Over temperature limiter]

(5) Check for during operation.

When an abnormality occurs during operation, the error content is displayed on the screen and the alarm sound is activated.

(6) Instantaneous Outage Recovery Features

If the instrument has a short period of power outage occurs within 30 seconds, the system returns to the previous operating status. [4.2.5 Instantaneous Outage Recovery Features]

2.2.3 Improved Convenience

(1) 3.5inch LCD display with a touch controller

The 3.5inch display secures an improved visibility and usability supported by a convenient touch screen.

(2) Start reservation, end reservation timer setting

You can schedule to start temperature control after the entered time. Once the temperature reaches to a target value, you can also set the timer to terminate the temperature control. [4.2.3 Refer to Timer Setting and Control]

(3) Auto-run function

The auto-run function saves the previous temperature settings for the system recovery from a power outage for more than 30 seconds. [4.3.6 Refer to Auto run]

(4) Screen lock function

You can active the screen lock function by touching the lock button at the top during the operation. Press the lock button once more to unlock the controller screen.

(5) LC-Connected service (option)

A remote controlling and monitoring system, LC-GreenBox (option), enables the users to control and monitor via smart devices. You can also enroll in a separate service to store and provide 30-day monitoring data.

2.3 Structure

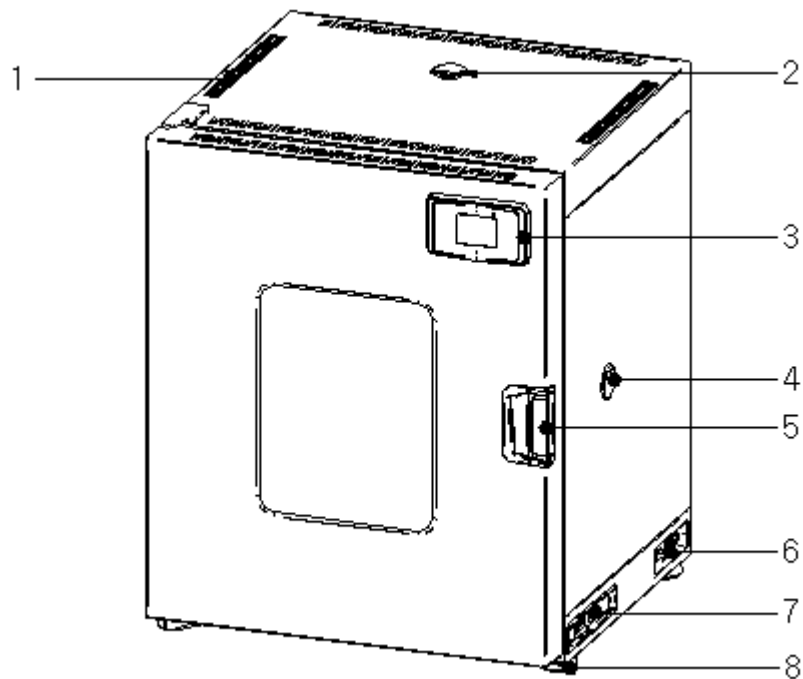

- (1) Main body
The main body is made of iron plate and painted with coatings.
- (2) Exhaust vent
It is an outlet for letting the air exhaust from the chamber. If you would like to adjust the amount of air to be exhausted, please turn the vent hole cover.

WARNING



- Since the instrument is in excessive heat, please wear gloves when controlling the vent hole cover. If you use wet gloves, it can cause burns on the hands, since it speeds up the temperature conduction of the high-temperature part.
- When a short circuit occurs due to aging of the device, never wear wet gloves or bare hands, since the operator can be electrocuted.

-
- (3) Controller
Various controllers and electrical components are embedded in the instrument.

(4) Ventilating hole

To control the amount of air to be exhausted, you can use the ventilating hole.

⚠ WARNING



- The instrument is in excessive heat, therefore please wear gloves when controlling the exhaust. Wet gloves can cause burns on the users' hands, since it speeds up the temperature conduction.
 - Also, wet gloves or bare hands are not allowed, since the operator can be electrocuted when a short circuit occurs due to aging of the device.
-

(5) Door handle

The door handle can open or close the door.

(6) Side panel-1

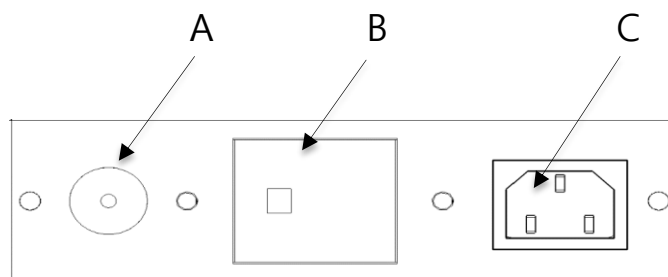

A) BMS connection port (Not selectable)

The BMS function is not provided in this model.

B) Circuit breaker

A circuit breaker is embedded to protect the device from short circuits or overcurrent.

C) Power cord socket.

The socket connects the power line to the instrument.

(7) Side panel-2

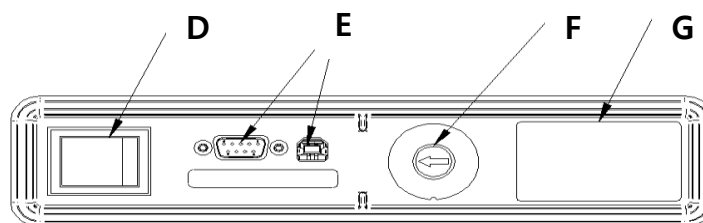

D) Main switch
It turns on and off the main power.

E) Communication port (Option)
The USB port and the RS232 port connects the device to a computer to monitor or operate the instrument. When connecting both ports at the same time, the USB will be recognized firstly.



If communication port is not selected as an option,  attached and the product is manufactured.

F) Over Temperature Limiter
If the heat rises excessive temperature, the temperature control stops, and a warning sign will be displayed on the screen along with a notification sound. Once you check the warning sign, please solve the problem, and reset the Over Temperature Limiter up to 15% higher than the original target temperature. You can restart the instrument by pressing the Start button.

G) Product Label
The label describes the instrument name and its type.

(8) Foot
It supports its body and prevents slipping.

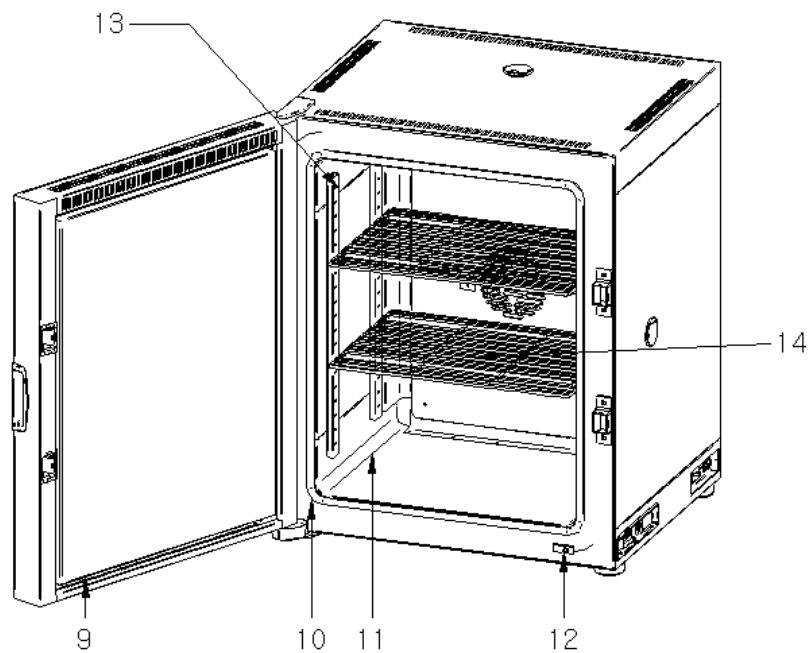

(9) Door

Space between door surface and the internal insulation part protects the door from being heated.

(10) Door packing

The door is packed with high-temperature silicone rubber to maintain airtightness.

(11) Chamber

The chamber is made of stainless steel. Inside the chamber, a fan, heater, temperature sensor, and temperature regulator are installed.

(12) Door limit switch

Door limit switch detects the opening and closing of the door. Once the door is opened, the controller stops the fan and the heater. If the door is opened for more than 2 minutes, the displays will show you an error message with an alarm sound. Moreover, the instrument operation will be stopped with the power disconnection with the Magnet Contact (MC).

(13) Shelf level adjustor

The shelf levels can be easily adjusted according to the height of the test sample. OVF-800 series has 9 to 19 shelf height adjustment holes, but for safety, it is recommended to install one shelf for two height adjustment holes for safety. Please refer to 8.1 Technical Specification for the maximum number of shelves.



(14) Shelf

Using shelf, you can place samples on it. Wire/Performed shells can be selected according to the type, characteristics, and size of the sample.

3.0 Installation

3.1 Components of the Instrument

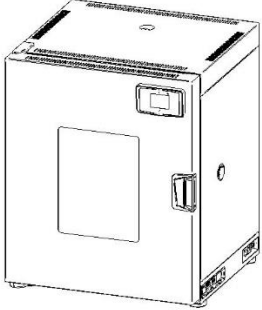
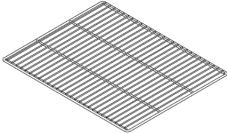
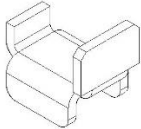
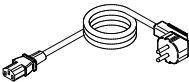
Please check all the components described in this manual after unpacking. Also, please check the ID label attached to the instrument and make sure it matches the model you ordered. If there is any component below that does not match with your order, please contact the branch or device seller of Cole-Parmer. Please refer to the 8.4 service contact information of our company.

Item	Figure	Quantity	Description
Unit		1	-
Shelf		2	-
Shelf Support (Please refer to 3.2.4)		8	-
Main cord		1	-
Operation manual		1	-

3.2 Preparations before installation

3.2.1 Installation Condition

Please follow the install guidelines between for your safety.

WARNING



- Do not install any gas pipe or water pipe around the instrument.
- Do not install in places with a risk of high humidity, short circuits, leaks, or flooding.
- If moisture or organic solvents flow into the control panel, short circuit may be occurred.



- Do not install the instrument in a place with a possibility of flammable gas leakage.
- Do not use or store flammable dust, combustible gas around this instrument.
- Operation of the device is prohibited in a place with a possibility of explosion due to organic evaporation gas.
- Do not use the device in places with industrial harmful gases, fumes, or metal dust.



- Do not expose the instrument to direct heat sources or direct sunlight.



- Maintain the temperature around the device at 5°C to 40°C.
(The optimal temperature is 25°C.)

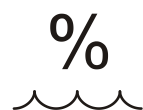

- Please keep the relative humidity below 80%.



- Install the device in a place below 2,000m above sea level.



⚠ CAUTION

- Do not install near instrument that generates strong high-frequency noise (high-frequency welding machine, high-frequency sewing machine, large-capacity SCR control).
- Please beware of using artificial heart pulses or magnetic data devices which may be affected by magnetic bars.
- Do not install any electrical instrument near the power terminals.
- Do not avoid unventilated corner. If ventilation is not sufficiently performed, heat dissipation will be in a risk of damage due to overheating.
- The instrument should be installed near the power outlet.

3.2.2 Installation Guidelines

Please follow the guidelines listed below.



⚠ WARNING

- Please install the instrument on a flat and solid floor for any case of an accident.
- Since the door is opened to the left with maximum 115°, please consider sufficient installation space.



⚠ CAUTION

- Please keep the appropriate space (typically at least 30 cm) between other devices or walls.

- (1) Please install the instrument inside the laboratory with a little human access.
 - (2) Install it horizontally on a solid and flat floor.
 - (3) Install it in a place without any direct sunlight and heat sources.
 - (4) Please install it in a place without water or steam effect.
 - (5) It is recommended to install it in a place where there is an exhaust system such as a fume hood or an arm hood.
 - (6) Please keep a certain space from the wall or other adjacent experimental equipment.
- In particular, the door of the device opens in the left direction, please make sure to have enough space on the left so that the door can be fully opened.

3.2.3 Minimum required space for Installation location

In order to install the instrument, you need to consider the size and rotational radius of the instrument. When installing it, you should keep a minimum space of the product to operate and maintain properly as shown in the figure below. It is also recommended to install it in an environment equipped with ventilation facilities such as a fume hood or arm hood.

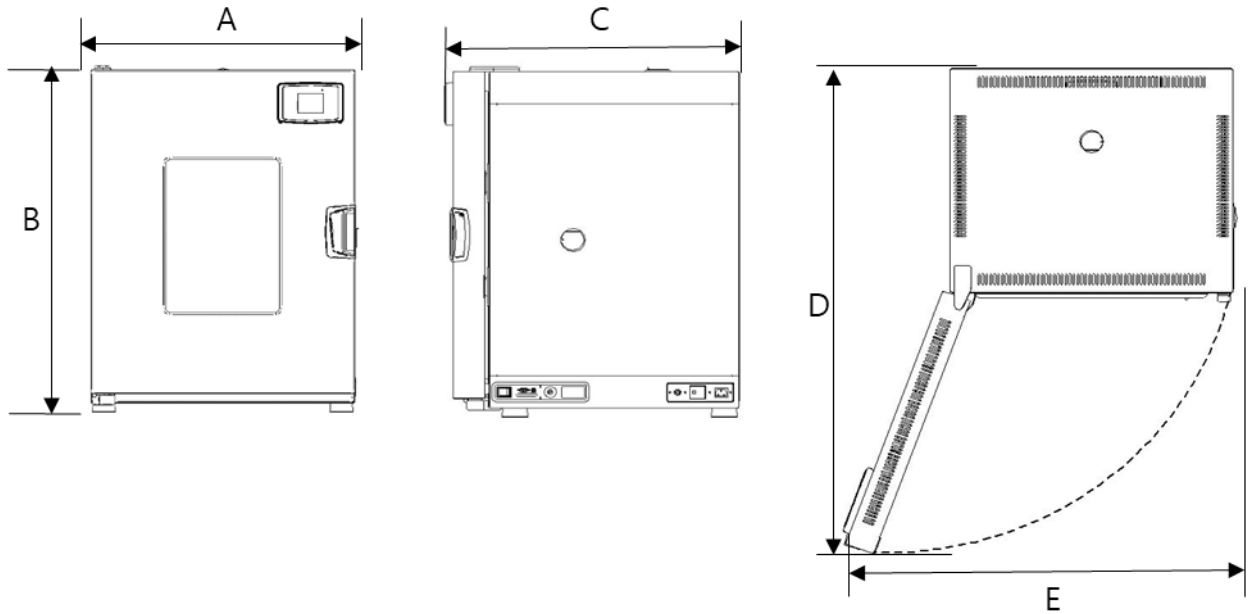

Description		Model	52412-15 52412-16	52412-17 52412-18	52412-19 52412-20	52412-21 52412-22
A	Exterior width		478	558	663	728
B	Exterior height		604	684	859	914
C	Exterior depth		527	648	677	704
D	Maximum depth with door open		868	1060	1185	1271
E	Maximum width with door open		695	809	958	1050

(unit: mm)



⚠ CAUTION

- Please avoid samples or shelves contacted to sensors.

3.2.4 How to install shelf and its support

You can adjust the height of the shelf by attaching the shelf support to the shelf adjuster on the side of the chamber as shown below.

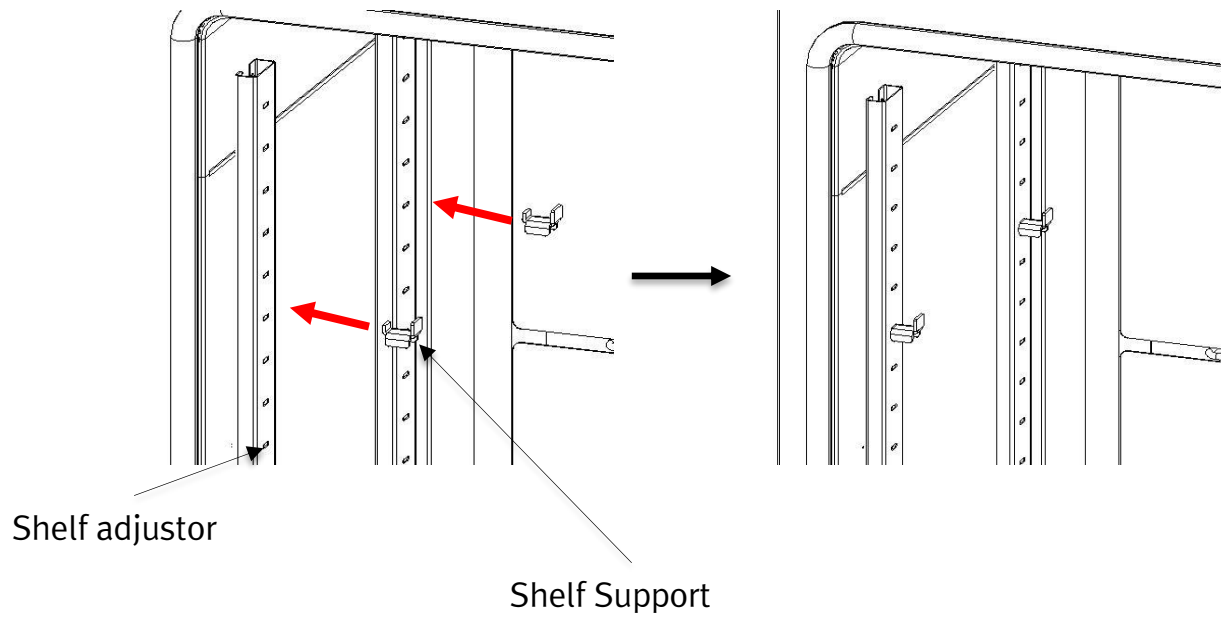

Place the shelf on the shelf support attached to the shelf adjuster. Depending on the model, up to 4 to 9 shelves can be installed.

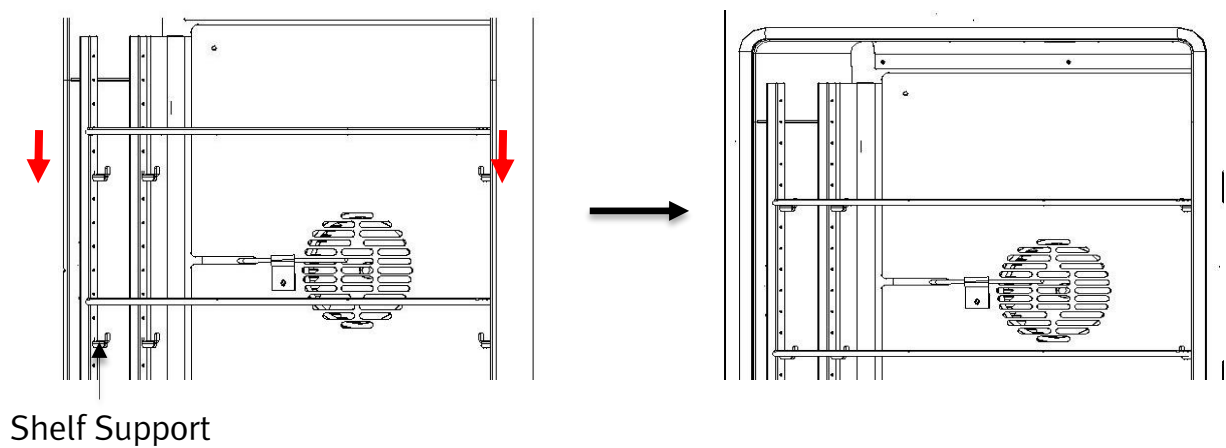

3.2.5 Available Space

Please make sure the available space around the instrument.

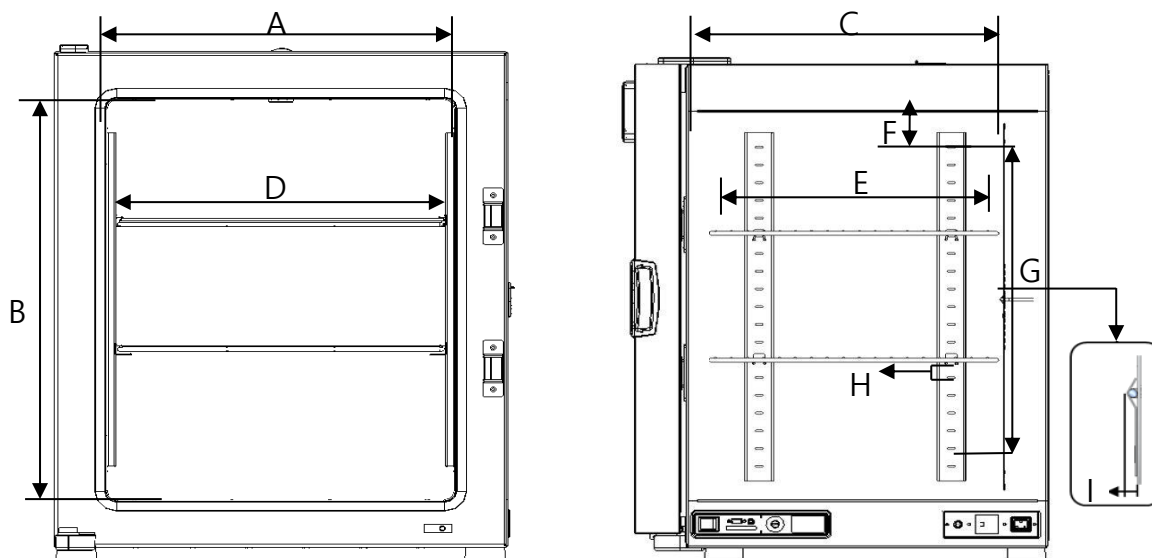

Description		Model	52412-15	52412-17	52412-19	52412-21
		52412-16	52412-18	52412-20	52412-22	
A	Interior width		300	380	485	550
B	Interior height		400	480	655	710
C	Interior depth		210	330	350	376
D	Shelf width		266	346	451	516
E	Shelf depth		195	315	335	361
F	The height between the top hole of the shelf installation and the inner top		80	90	87.5	85
G	Height between the top hole and the bottom hole of the shelf installation		240	300	480	540
H	Spacing of Shelf installation Holes		30	30	30	30
I	Sensor installation depth		3.8	3.8	3.8	3.8

(unit : mm)



CAUTION

- Please avoid the contact between sensor and self/ samples.

3.3 The labels attached to the instrument

1) ID label

An ID label of the basic information is attached on the panel of the right side of the instrument. Before using it, please check the voltage, phase, and capacity of the power indicated on the ID label.

2) Safety label

Safety labels are attached to the instrument to provide important information about potential risks or how to avoid them. For safe operation, all users must check the safety label before using it and read the 1.4 Instructions for Safe Use (required reading) carefully to understand the relevant safety guidelines. If the safety label is damaged, please ask the Cole-Parmer branch or seller for a new label.

3) Custom Logical Safety (CLS)-Control System Label

It is a label that certifies that the CLS-Control system, the highest safety level control device, is applied. [2.2.2 Refer to Safety Enhancement]

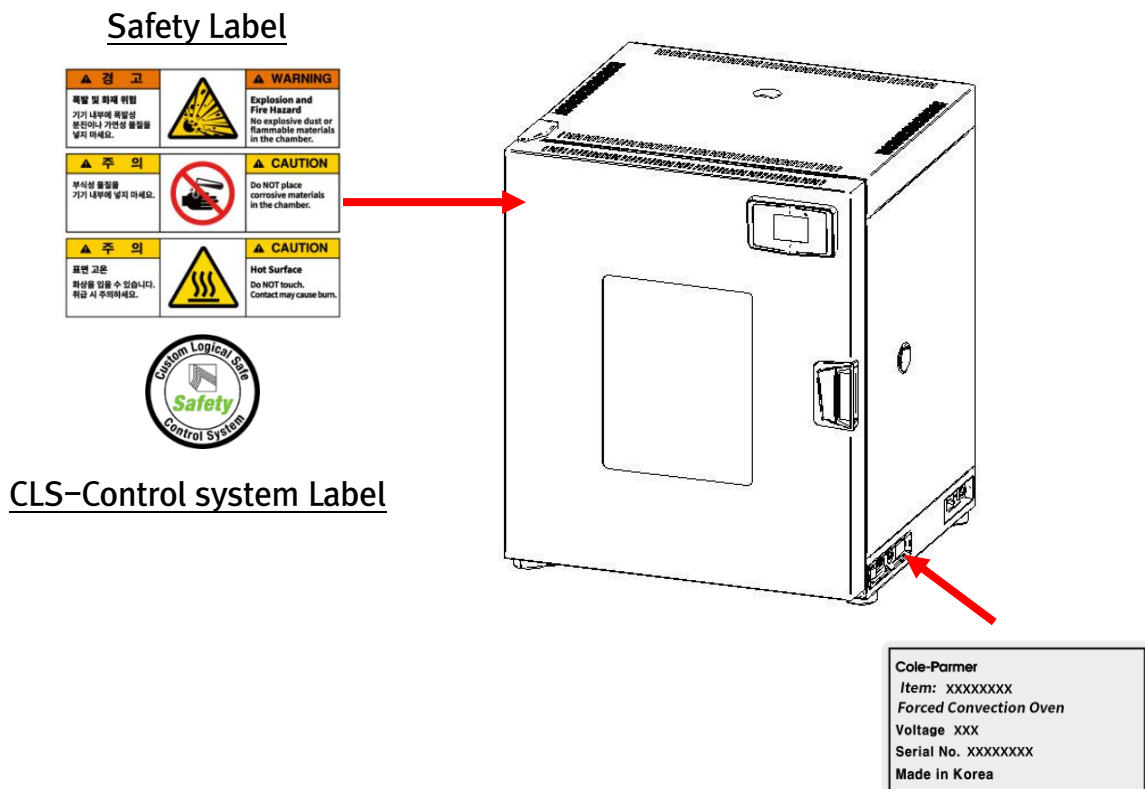

3.4 Power Connection

1) Before connection to a power, please follow the guidelines listed below.

WARNING



- Before installing the product, please check the voltage, phase, and capacity of the power and connect it correctly.
- Make sure to use a power source with a grade 2 or higher ground. Also, never ground it to a gas pipe or water pipe.
- Do not connect to one outlet and use it with other devices at the same time.
- Never use branch sockets or double tabs. In the event of an overcurrent, there is a risk of damage to the cable, damage to the device, and fire.
- Operation of the device is prohibited when there is damage to the power line.
- Inappropriate power connection can cause damage to the device and serious injury or death to the human body.
- Do not handle or touch electrical cord or electrical components with wet hands.

CAUTION



- When installing and operating, please make sure to use the outlet provided with the ground terminal for the power cord.
- Accurately fasten the power plug so that it does not shake.
- Avoid placing heavy things over the power cord or let the cord pressed under the device.
- After use, please be sure to turn off the main power switch and unplug the power cord.

2) Please follow the step-by-step guidelines to supply power to the instrument.

- (1) Make sure the power switch, circuit breaker is off before supplying power.
- (2) Connect one side of the power plug to the power input terminal on the side of the body.
- (3) Connect the other side of the power plug to a power outlet.
- (4) Turn on the power switch and circuit breaker to supply power to the device.

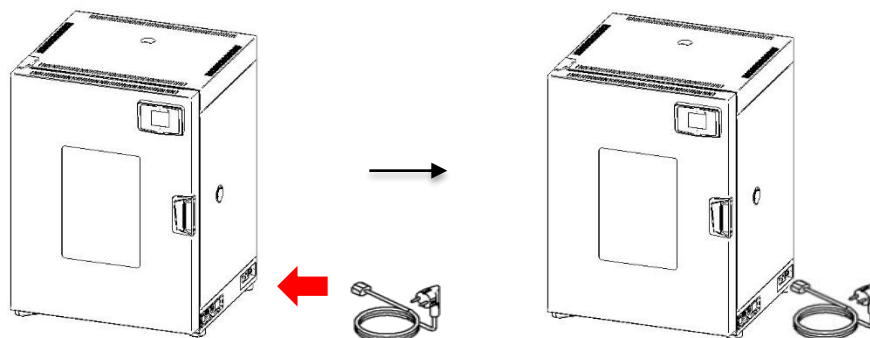

3.5 Checklists before the Use

When operating the instrument, please keep the following warnings.

(1) Warnings for use of chemical materials



WARNING



- Do not put any substances that can cause toxic gas inside the instrument.
 - Do not put flammable dust inside the instrument. If combustible dust enters the heater, it may cause a fire or explosion. This device is not an explosion-proof structure.
 - Do not place explosive, flammable, flammable, or oxidative chemicals such as alcohol, benzene, gasoline on top of the device, store them, or put them in the instrument and operate them. There is a risk of fire. This device is not an explosion-proof structure.
-

(2) Warnings for Use of the Instrument



WARNING



- Do not operate devices that have been damaged or have short circuits.
 - Do not use the device if strange sounds, smells, or smoke occur on the instrument.
 - Make sure to wear safety equipment (work clothes, gloves, safety goggles).
-

(3) Warnings for instrument damage

WARNING



- Avoid moisture, organic solvents, dust, corrosive gases entering the instrument.



- Do not place a liquid-storing container on the top of the instrument. Spills of liquid may cause damage to the instrument.
-

(4) Cautions for the Use of the Instrument

CAUTION



- Please wear gloves when handling samples to avoid burns, as there may be residual heat even after the power is off.



- Before using the instrument, please make sure the inside of the chamber is clean all times.
- If this instrument has moisture, please stop operation immediately, disconnect the power cord, and request for a technical service.



- Do not put conductive or combustible objects inside the vent pipe. There may be a risk of fire or electric shock.

- Be careful not to damage accessories or systems inside the instrument.



- Do not give a strong shock or vibration to the instrument.
 - Avoid contact with pesticides or flammable gases.
-

4.0 Operation

4.1 Controller Home Screen names and functions

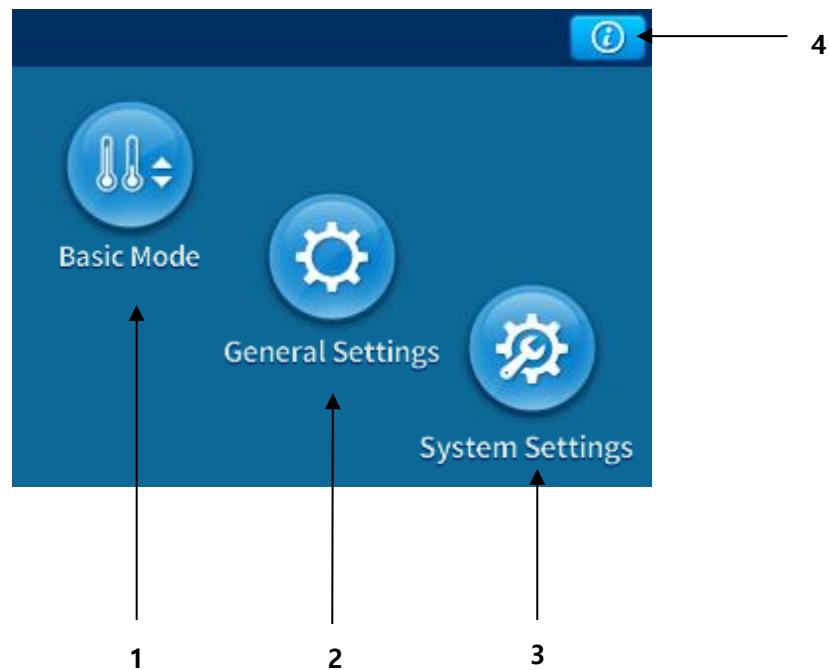

	Menu	Functions	Chapters
1	Basic Mode	Temperature control is possible by setting functions such as temperature setting, timer [start reservation, end reservation] setting, temperature control and stop.	4.2
2	General Settings	You can check and change the settings of the device, such as sound settings, date/time modification, and language selection.	4.3
3	System Settings	You can set and change the alarm settings, password settings, factory initialization, etc.	4.4
4	Information	You can check the version, model name, and information of the firmware.	-





4.2 Basic Mode

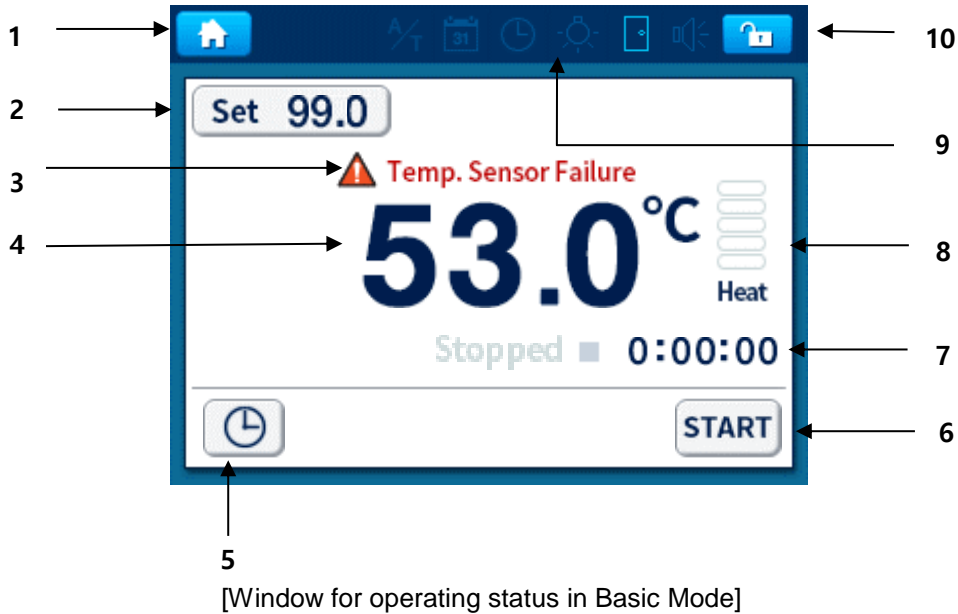



Basic mode is used when the user controls the temperature inside the chamber by one temperature point. You can change the target temperature and timer value before and during the instrument operation.

Press the Basic Mode button  on the home screen to go to Basic Mode.



(1) Status Display and menu

1		You can move to home screen. (When the power is turned on, it automatically enters the basic mode. You can use this button to make general and system settings.)
2		You can set the target temperature value.
3	Warnings	When a warning occurs, an alarm sign appears, and a pop-up notification window appears.
4	Current Temperature	Indicates the current temperature inside the chamber.
5		Timer Setting: You can set the start/ stop timer.
6		It is a button to start temperature control and the text will be changed to “STOP” once the instrument starts.
7	Operating status and running time	Depending on the operating status, it displays the operating time or remaining time of timer with the phrases in operation, start reservation, and reservation, and running, stopped.
8	Heating amount	Displays current heating amount

9	Operating Status	 Auto Tuning  Setting Timer  Door Open/ Close  Sound On/ Off
10		Screen lock On/Off

4.2.1 Start and Stop in the Basic Mode

If the device temperature control is stopped, you can start the temperature control by pressing the start button on the touch screen. After finishing the temperature control, you can stop the control by pressing the stop button on the touch screen.

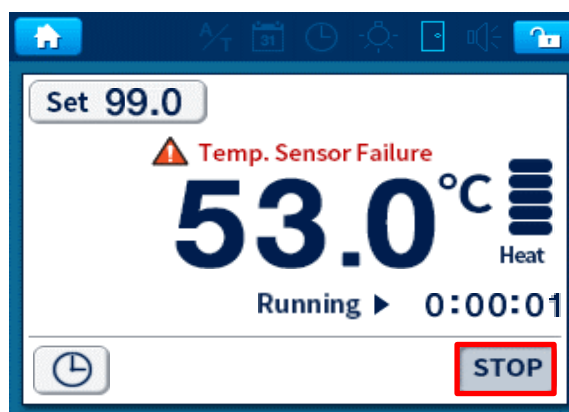
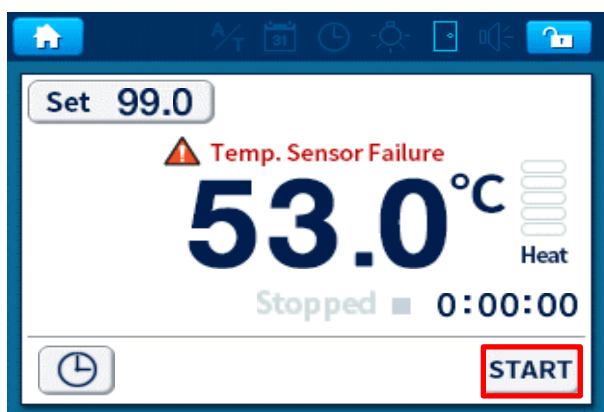

NOTICE

- If you try to control the instrument when the doors is opened, it will not operate with a door-open sound. Please close the door and restart it.
- If the door is opened while the device is operating, the fan and heater will stop operating, and a door-open warning message will be shown without a notification sound. If the door is closed within the 'Door Open Delay Alarm' time entered in System Settings > Alarms [4.4.4 Refer to Alarm], the previous operation continues. If the door is not closed within the entered time, a warning sound is issued a pop-up will appear. When the warning pop-up is displayed, the instrument will not work even when the door is closed. To restart the instrument again, please close the door, check the warning sign, and restart the instrument.

4.2.2 Temperature Settings

(1) On the home screen, press the Basic Mode button and press the button **Set 99.0** on the upper left..

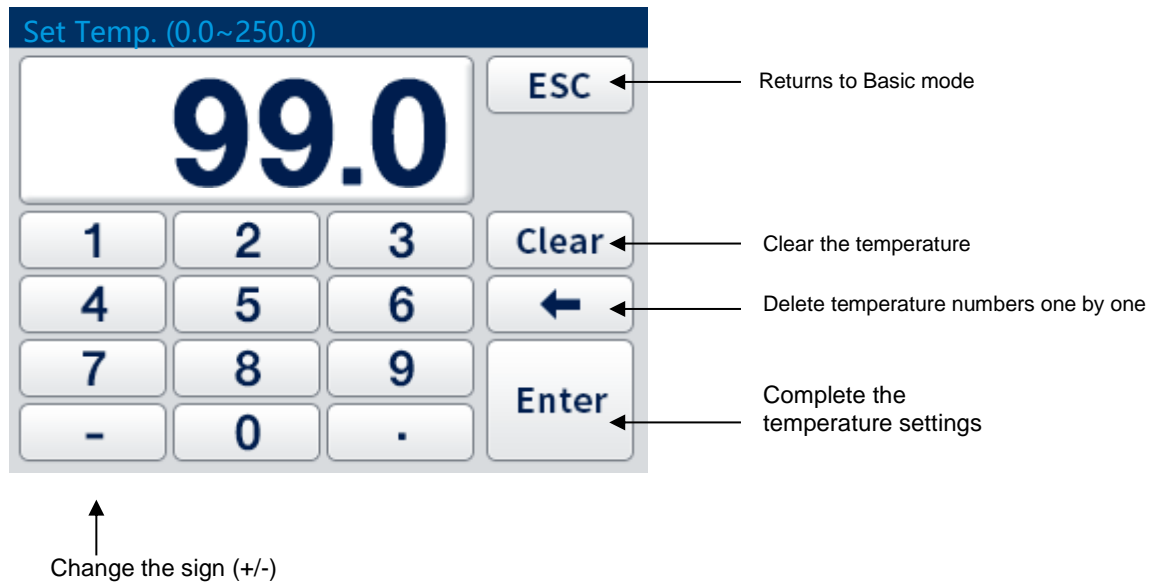

(2) When you enter the temperature settings, press the keypad to change the temperature value of the desired temperature. Press Enter to return to the basic mode. (If you press the ESC button without pressing Enter, the temperature settings will be canceled.)

NOTICE

- The set temperature can be input from 0 to 250°C, and the temperature control range of the device is Amb. +10 ~ 250°C
- To set and start the temperature control, please press the start button.
- When the set temperature is changed through (1) to (2), the temperature control will start immediately to reach the target temperature.

4.2.3 Timer Settings and Control

This instrument has a wait on timer function to control the temperature control of the device after a set time. And after reaching the set temperature, there is a wait off timer function to control the temperature maintenance for a set time.

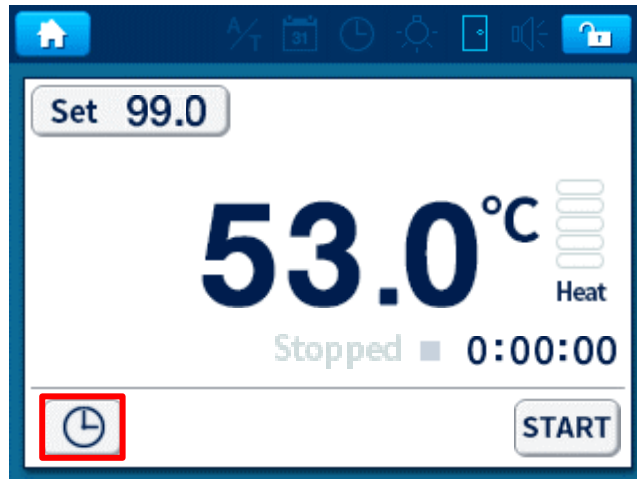

- (1) Move to Timer Settings by pressing the button,  in the Basic Mode.

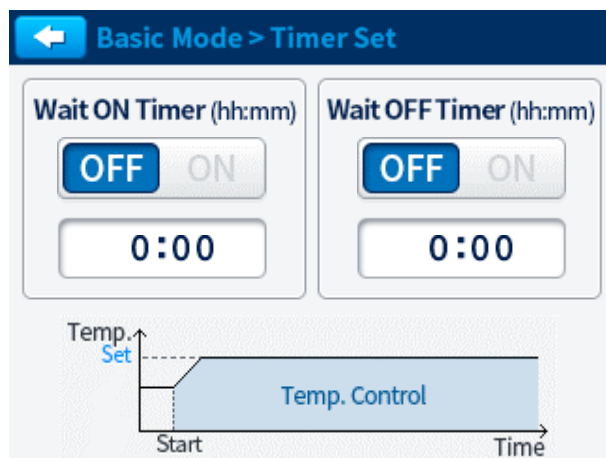



[The main menu of the timer settings]

- (2) Press the ON button of the “Wait ON Timer” and “Wait OFF Timer” you want to set.

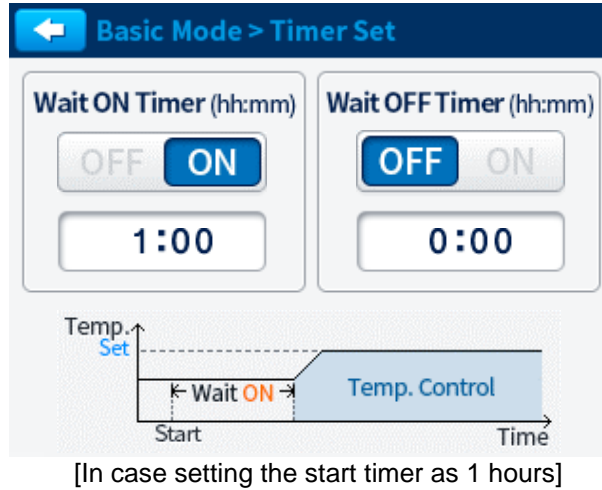
- (3) Enter the “Timer Set” with the unit of “hh:mm”.



- (4) You can return to the “Basic Mode” screen by pressing  button with the Wait ON/OFF timer applied. When the timer setting is completed, the icon,  will be shown on the screen.

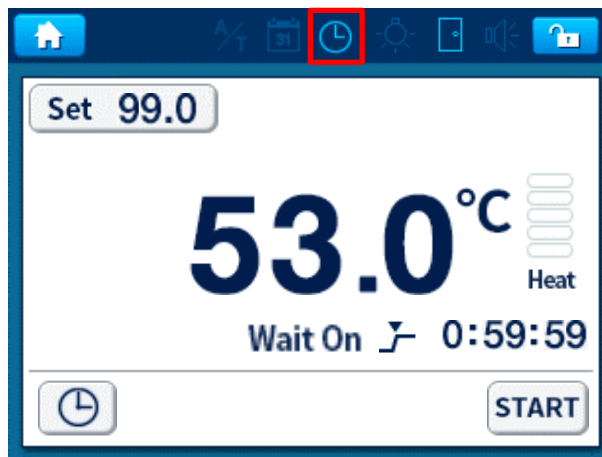

NOTICE

How to reserve the Wait ON/OFF timer

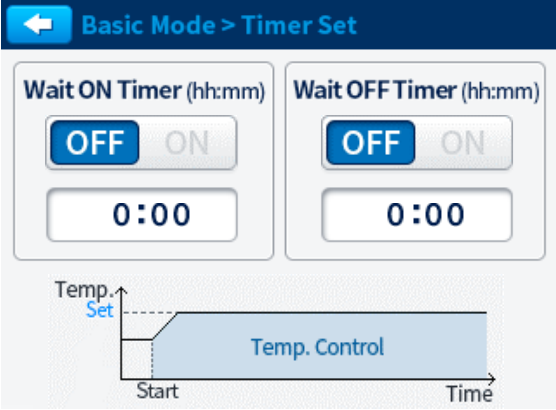
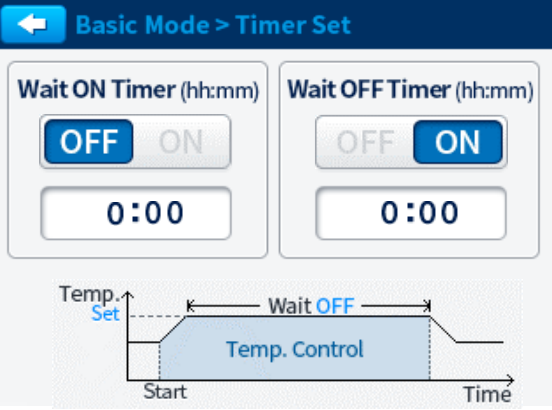
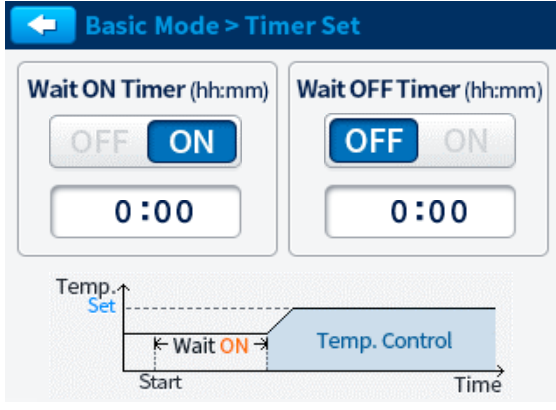
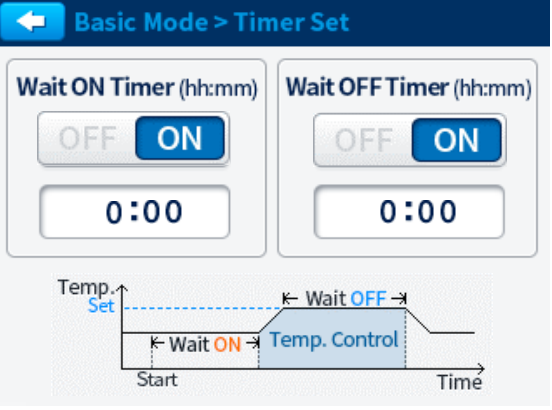
<p>In case of Wait ON Timer is OFF / Wait OFF Timer is OFF</p>  <p>- The initial setting is shown as above. - Timer set does not apply to this instrument.</p>	<p>In case of Wait ON Timer is OFF / Wait OFF Timer is ON</p>  <p>- If you only set the Wait OFF timer, the temperature will maintain only for the entered time once it reaches the target temperature. - The temperature control will be terminated if all the reserved end time is passed.</p>
<p>In case of Wait ON Timer is ON / Wait OFF Timer is OFF</p>  <p>- If you only set the Wait ON Timer as ON, the instrument waits for the input value before raising the temperature as the set value. - In this case, the heater will be continuously working to maintain the set value until the user stops the instrument.</p>	<p>In case of Wait ON Timer is ON / Wait OFF Timer is ON</p>  <p>- If you turn on both Wait ON Timer and Wait OFF Timer, you can set the delay time before starting the heater and also set the maintaining time to last the set temperature. - In this case, the heater operation starts after all the time set in the Wait ON has elapsed. After reaching the target temperature set by the user, the target temperature is maintained for the time set by the Wait OFF. Temperature control is terminated when all of the set Wait OFF time has elapsed.</p>

4.2.4 Checking the Operation after Timer Setting

- In case Wait ON Timer is set
 - (1) After setting the Wait ON timer, press start.
 - (2) After the Wait ON Time, the heater operates to reach the setting temperature.
(If you set up the Wait OFF Timer, the Wait OFF Timer works automatically once the set temperature has reached.)

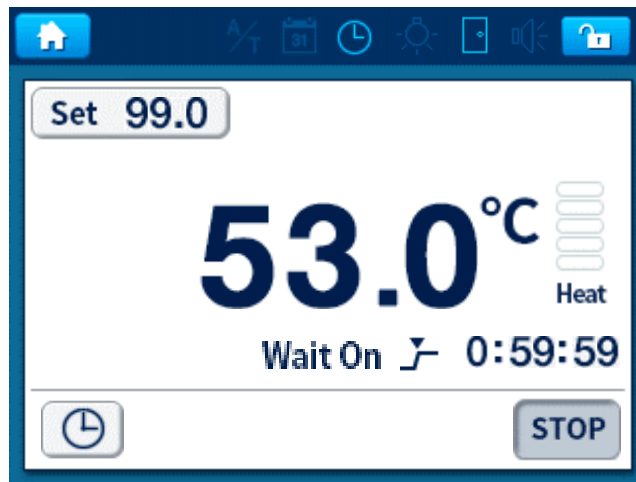

- In case Wait OFF Timer is set
 - (1) If you press the start button after setting the Wait OFF Timer, the instrument start the heating operation.
 - (2) The Wait OFF Timer starts once the target temperature has reached.
 - (3) Once the Wait OFF Timer reaches its input time, the instrument stops operation.

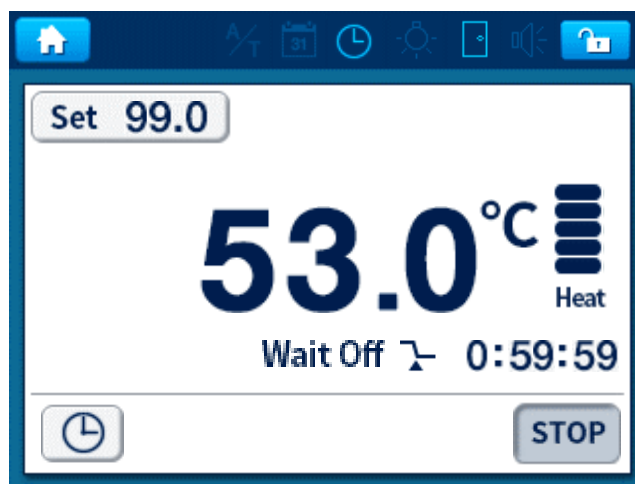

NOTICE

- If the Wait ON Timer and Wait OFF Timer are both set, the activated timer and the remaining time will only be shown in the display.
- If you press the start button when the instrument is not operating, the timer starts the temperature control according to the Wait On Timer/ Wait OFF Timer.
- If you set the Wait OFF Timer while the instrument is in operation, the new timer will be applied immediately without having to press the Start button again.
- If you want to change the Wait OFF timer during timer operation, you must turn off the Wait OFF Timer and reset the process.

4.2.5 Instantaneous Outage Recovery Function

If the power is restored within 30 seconds of an instantaneous power outage, please follow the following procedure.

Before the Instantaneous Outage	Operation after Recovery from Instantaneous Outage in Basic Mode Control
Stopped	Stop
Running	Run
Wait ON Timer is On	The elapsed time of the Wait ON Timer will not be saved, and will be started with the initial value.
Wait OFF Timer is On	The elapsed time of the Wait OFF Timer will not be saved, and will be started with the initial value.

4.3 General Settings

In General Settings, you can check and change the settings for Sound & Display, Clock, Language, Auto Run & Safety Lock Door, Event, Communication.

Pressing the General Settings  button in the home screen takes you to the General Settings.

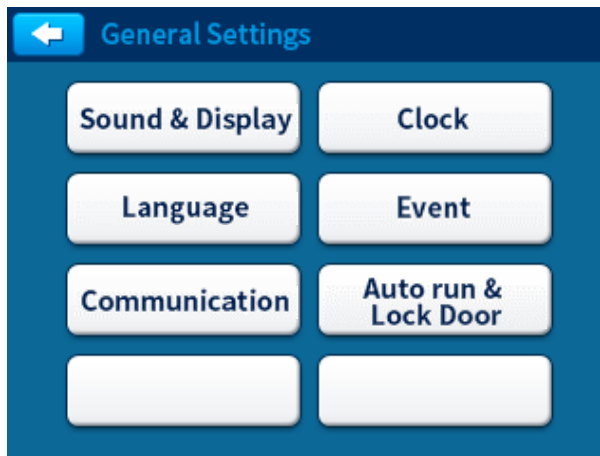

4.3.1 Sound & Display

In Sound & Display, you can set the sound generated when the screen is touched, on lamp by door and the Display Auto Dim function.

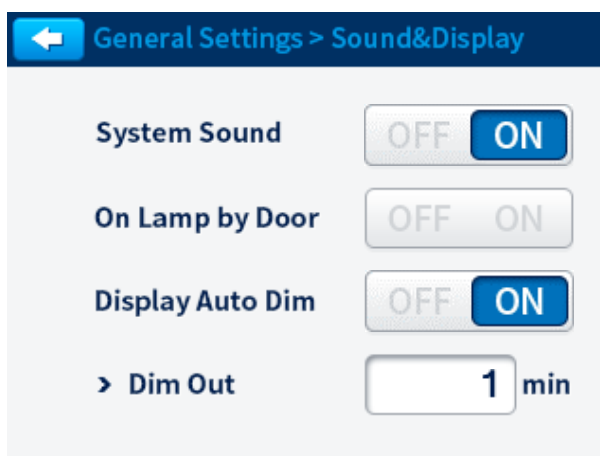

Item	Function	Input Value	Default
Sound Settings	Set the System Sound (touch screen sound). Even if it is set to OFF, an alarm sound occurs.	Off / On	ON
Display Auto Dim	Set the display Auto Dim function. If the touch screen is not touched for the entered time, the display turns off automatically.	Off / On	ON
Dim Out	Set the time for the display to turn off automatically.	0 ~ 30min	1

NOTICE

- OVF-800 Series does not support the on lamp by door.

4.3.2 Clock

The Clock is a function that sets the time within the device. The time set in the Clock is the standard for the date and time of the event recording [4.3.4 Refers to 4.3.4 Event].

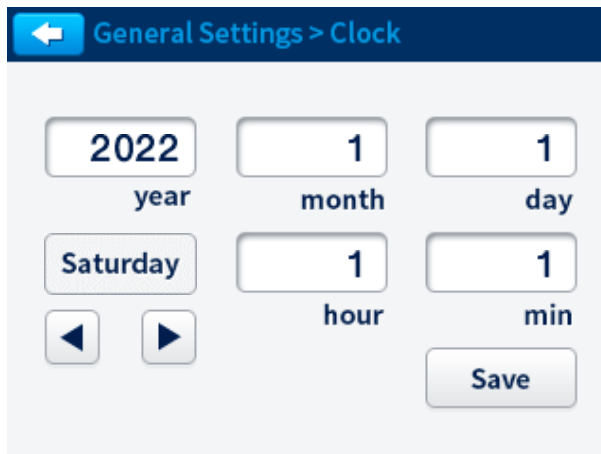

- (1) Choose an input field that you want to change among year, month, day, hour and minute.
- (2) You can enter the value when the keypad window pops up.
- (3) You can select the day of the week with the left and right arrow buttons.
- (4) Press the  button to save the changed value.

NOTICE

- If you press  button before saving, it cancels the changes and returns to the previous screen.

4.3.3 Language

You can set the default language that appears on the device. The default language is English (Korean/Chinese will be supported later).



4.3.4 Event

Event is the function to indicate the start of control and errors occurred in the device.

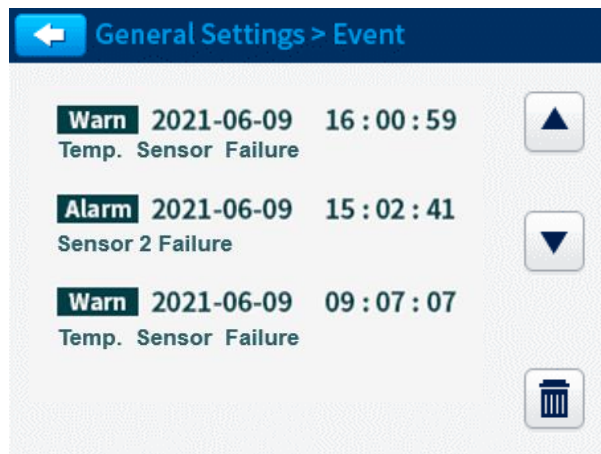

The latest event occurrence and time are displayed. Up to 4 events can be displayed on one screen, and you can move up to 3 pages by arrows. It can record up to 12 events.

Either pressing the  button or turning off the power clears all the recorded events.

⚠ WARNING

- If there are more than 12 event records, they are automatically deleted sequentially from the oldest.
- Click the "Delete" button to delete all existing records of the Event History.
- All event history will be deleted once the instrument power is turned off.

4.3.5 Communication

It is the function that allows communication settings with LC-GreenBox (Option).

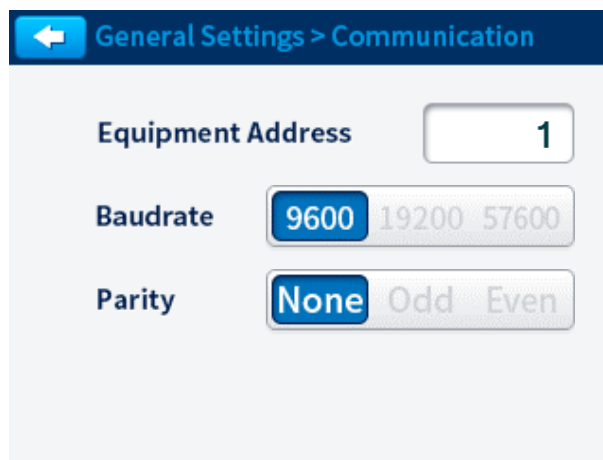

Item	Function	Value Range	Initial Value
Equipment Address	Set communication Address.	1~255	1
Baud Rate	Set Communication Rate.	9600,19200,57600	9600
Parity	Set Communication Parity.	None, Odd, Even	None

NOTICE

- When using the LC-GreenBox, the Equipment Number must be set to the same number (1~4) you want to connect to the LC-GreenBox. Set the Baud Rate 9600 and Parity None.

(Check the user manual of LC-GreenBox for more information.)

4.3.6 Auto Run

When power is turned off and restored after more than 30 seconds, Auto Run function makes the user set the function to determine whether or not to operate by remembering the state before the power turns off.

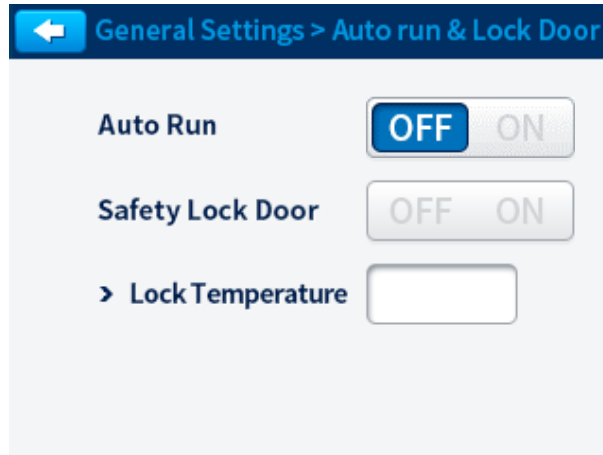

Item	Function	Input Value	Default
Auto Run	When the power is turned off for more than 30 seconds during temperature control and restarts, set the function to automatically run at the previously set temperature.	Off / On	OFF

NOTICE

If the user sets the Auto Run and the power is restored after the device is turned off for 30 seconds or more during temperature control, follow the procedure below.

Previous States	Operation in Basic Control	
	Auto Run Off	Auto Run On
Stopped	Stop	Stop
Running	Stop	Operation
Wait ON Timer	Stop	The elapsed time of the Wait ON Timer is not restored and returns to the initial setting.
Wait OFF Timer	Stop	The elapsed time of the Wait OFF Timer is not restored, and starts from the beginning.

※ Refer to [4.2.5 Instantaneous Outage Recovery Function] for operation by instantaneous power failure (recovery before 30 seconds).

※ Safety Lock Door function is not embedded in the OVF-800 Series.

4.4 System Settings

In the System Settings, you can check and change the settings for Temperature Input, Calibration, Auto Tuning, Alarm, Password, and Factory Default.

- (1) If you press the System Settings  button on home screen, the password window appears.

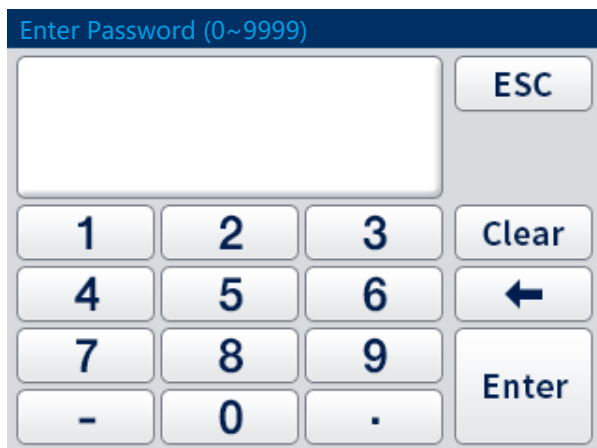

The image shows a password entry screen with a dark blue header containing the text "Enter Password (0~9999)". Below the header is a white text input field. To the right of the input field is a button labeled "ESC". Below the input field is a numeric keypad with buttons for digits 1 through 9, 0, and a decimal point. To the right of the keypad are three buttons: "Clear", a left-pointing arrow, and "Enter".

- (2) After entering the set password, press the Enter button to go to the System Settings window.
※ The initial password is set to '0000'.

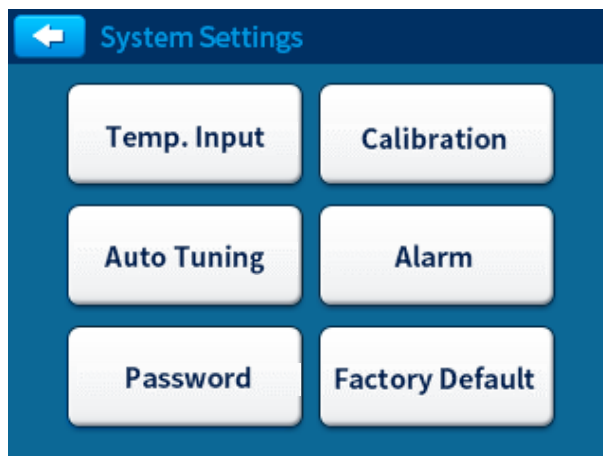

The image shows the "System Settings" menu with a dark blue header containing a left-pointing arrow and the text "System Settings". Below the header are six white buttons arranged in a 3x2 grid. The buttons are labeled: "Temp. Input", "Calibration", "Auto Tuning", "Alarm", "Password", and "Factory Default".

4.4.1 Temperature

Temperature can be set for the temperature unit and decimal point unit displayed on the screen.

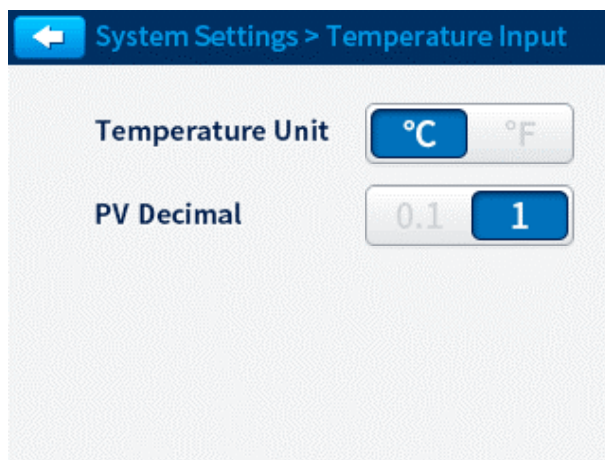

Item	Function	Input Value	Default
Temperature Unit	Set the unit of temperature.	°C / °F	°C
PV Decimal	Set the decimal place.	0.1 / 1	1

4.4.2 Calibration

When measuring the temperature inside the chamber by using the user's temperature sensor, if there is a temperature difference between the temperature sensor inside the device and the user's temperature sensor, you can calibrate the temperature sensor inside the device according to the user's temperature sensor. It is possible to calibrate temperatures accurately at up to three temperature points.

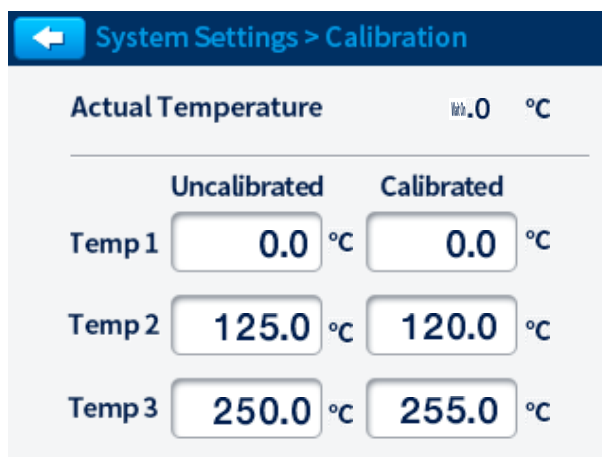

- (1) Specify Temperature 1, Temperature 2, and Temperature 3 to calibrate the temperature sensor inside the device and record them in the note (However, Temperature 1 < Temperature 2 < Temperature 3).
- (2) Go to the Basic Mode and set the set temperature as the Temperature 1 to be calibrated.
- (3) When the temperature converges to the set temperature and becomes stabilized, measure the internal temperature using the external temperature sensor and record it in the note.
- (4) Proceed with (2)~(3) by changing Temperature 1 to Temperature 2 and Temperature 3 and record the temperature measured by the external temperature sensor in the note.
- (5) You can go to System Setup> Calibration and enter Temperature 1, Temperature 2, and Temperature 3 in the Uncalibrated column. Also, enter the internal temperature measured by the external temperature sensor in the Calibrated column to complete the temperature calibration.

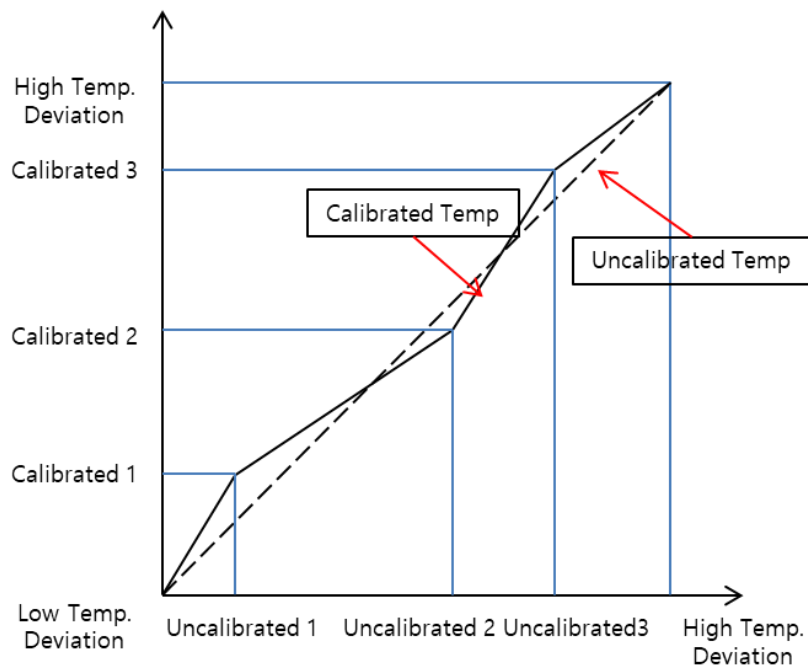

Item	Uncalibrated Input Value	Default
Temperature 1	-20~(Temperature2 -1)	0
Temperature 2	(Temperature1 +1) ~ (Temperature 3 -1)	125
Temperature 2	(Temperature2 +1) ~ 270	250

4.4.3 Auto Tuning

It is a function to update the PID control parameters for temperature control. Optimum temperature control can be performed at the main operating temperature. The product is factory-set to perform temperature control in the temperature control area.



When using the device, if the device does not properly control the temperature due to a rapid change in the operating environment (such as right after the purchase of the device or the reinstallation due

to relocation) with respect to the user's main operating temperature, Auto Tuning can be done for accurate temperature control.

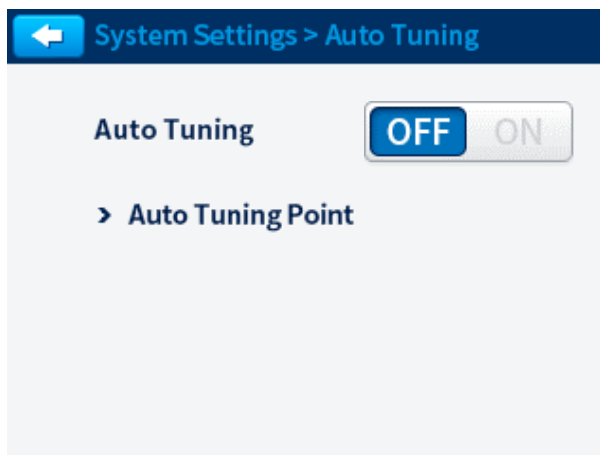
Auto Tuning temperature is performed by setting the target temperature value in the Basic Setting Mode and starting the control, then activate the Auto Tuning button to ON in System Setup> Auto Tuning.



[How to set Auto Tuning]

- (1) After setting the temperature in Basic Mode, press the start button.
- (2) It is executed when the ON button is activated in the System Settings> Auto Tuning screen. The Auto Tuning function cannot be used when operation is stopped or in program control.
- (3) It moves directly to the operation display window of Basic Mode, and the icon  on the top status bar blinks indicating that Auto Tuning is running.
- (4) When Auto Tuning is completed, the icon  on the top status bar disappears and the Auto Tuning value is automatically saved.

NOTICE

- Auto Tuning may take tens of minutes or hours depending on the set temperature.
- Do not turn off the power of the device while Auto Tuning is in progress.
- During Auto Tuning, it is recommended that the difference from the ambient temperature be at least 30 degrees. If the Auto Tuning temperature is similar to the ambient temperature, the reliability of the optimal parameter value may be reduced.
- Auto Tuning is not available when temperature control is stopped in Basic Mode or under temperature control in Program Mode.

4.4.4 Alarm

It is a function to generate an alarm when the temperature is above or below the user-specified temperature or when the door is opened [4.5.3 Refers to Alarm Display and Pop-up Notification Function].

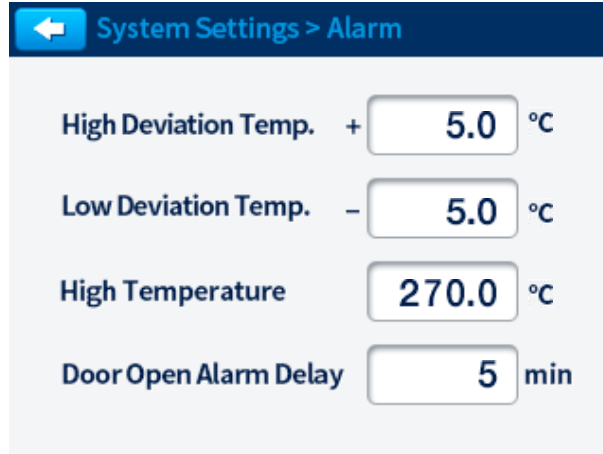

Item	Function	Input Value	Default
High Deviation Temperature	Set the upper limit of temperature deviation. If the actual temperature becomes higher than the target temperature + allowable upper limit temperature, an alarm is generated.	0 ~ 250°C	5
Low Deviation Temperature	Set the lower limit of temperature deviation. If the actual temperature becomes lower than the target temperature - allowable lower limit temperature, an alarm is generated.	0 ~ 250°C	5
High Temperature	Set the absolute upper limit temperature. An alarm occurs if the actual temperature exceeds the absolute upper limit temperature.	0 ~ 270°C	270
Door Open Alarm Delay	Set the alarm for the door open delay time. If the door opens exceeding Door Open Alarm Delay, an alarm occurs.	Off (0) ~ 30min	5

4.4.5 Password

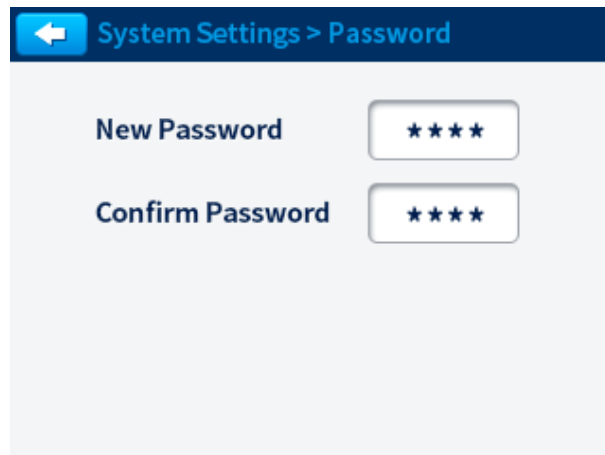

The initial value is set to '0000'.

Enter the desired password and press the back button  to complete the saving.

4.4.6 Factory Default

It is a function that initializes all values in the device at once.

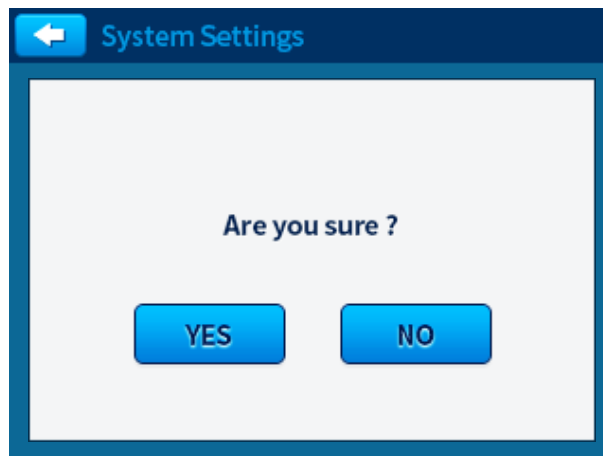

If you press the reset button, a pop-up notification appears and confirms whether or not to proceed with Factory Default.

This function initializes all settings changed in the Basic Settings, General Settings, and System Settings into the Factory Default values. When performing Factory Default, please be careful that all the values such as Auto Tuning and Temperature Calibration in the System Settings and General Settings are initialized.

4.5 Safety Function

4.5.1 Safety Functions Related to Temperature

(1) Temperature Limiter [4.6 Refers to Over Temperature Limiter]

If the temperature of the chamber rises abnormally above the set temperature (over 10~15% of SV) by using the electronic temperature limiter, an alarm sounds and the operation of the device stops.

4.5.2 Safety Functions Related to Use

(1) Door alarm

When the device operates with the door open, a beep sounds. Please close the door and try again.

If the door is opened while the device is operating, the heater stops and a warning message for door open appears. But there is no alarm sound. If the door is closed within the Door Open Alarm Delay time (default setting: 5 minutes), the previous operation continues. If the door is not closed after the entered time, a warning pop-up window appears with a beep. If a warning pop-up window is displayed, the device does not work even if the door is closed. In order to start the device again, close the door, check the warning pop-up window, and restart the machine. [4.4.4 Refer to Alarm for changing the Door Open Alarm Delay time]

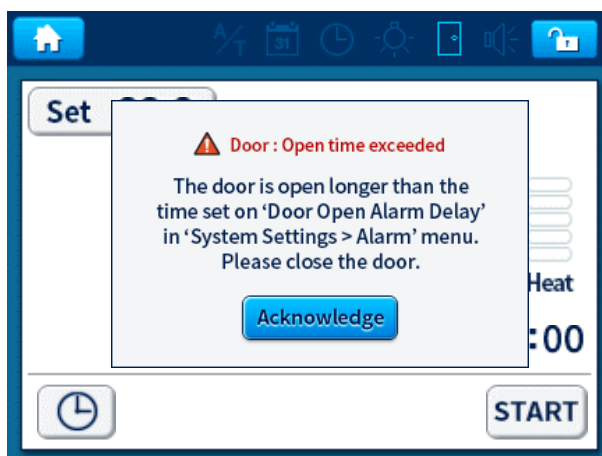

(2) Touch Screen Lock Function









This button  is to turn on/off the lock function so that the touch screen cannot be used during the device operation.

(3) Circuit breaker

A circuit breaker is embedded to protect the device from short circuits or overcurrent.

4.5.3 Alarm Display and Pop-up Notification Function

This device provides Alarm Display function as shown in the table below for various states of the device. In addition, if a problem occurs with the device during the system use, the following pop-up windows are provided to give information on problem solving. Check the notification message and please contact a service center referring to **8.4 Service Contact**.

Alarm Display Image	Contents
 High Temp. Deviation	Alarm displays when the actual temperature is higher than the target temperature + allowable upper limit temperature
 Low Temp. Deviation	Alarm displays when the actual temperature is lower than the target temperature – allowable lower limit temperature
 Warning : Over Temp.	Alarm displays when the temperature is over the absolute upper limit temperature that the device set
 Heater Disconnction	Alarm displays when there is a problem with the heater or SSR
 High Temp.	Alarm displays when the temperature of the device is higher than the temperature set in Over Temp Limit.
 Door : Opened	Alarm displays when the door is open.
 Door : Open time exceeded	Alarm displays when the door opens longer than the Door Open Alarm Delay time.
 Temp. Sensor Failure	Alarm displays when there is a problem with the temperature sensor.
 Board Failure	Alarm displays when there is a problem in the temperature detection circuit.

4.6 Over temperature limiter

Over Temperature Limiter is a device to prevent fire due to overheating. If the temperature of the heater rises abnormally above the temperature set in the Temperature Limiter, the temperature control is stopped and a warning window is displayed with a beep.

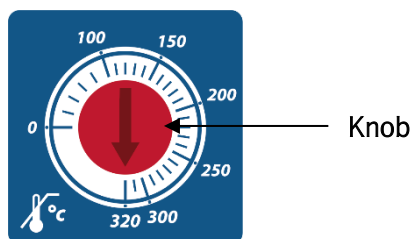

[Over temperature limiter]

※ If you want to use the Over Temperature Limiter as a temperature limiting function for sample protection, set it in the following order.

- (1) After setting the internal temperature of the instrument, press the Start/Stop button to operate the device.
- (2) When the target temperature is reached, the instrument should be stabilized for a certain period of time.
- (3) Turn the red knob counterclockwise using a screwdriver. Stop the knob when a warning is displayed on the screen with a notification sound.
- (4) Turn the red knob clockwise to set it at least 15% higher than the target temperature. (If you turn the knob clockwise, you can see that the temperature limiter is operating.)
- (5) Press the Start/Stop button twice.

※ During temperature control, if an alarm sound and an over temp warning window are displayed due to overheating, check the warning window and solve the cause of the problem. When the temperature goes down, it works again. If it is necessary to continue control with the same temperature, turn the red knob on the temperature limiter to set the temperature at least 15% higher than the set temperature, and press the Start button once to restart the unit.

5.0 Maintenance

5.1 Inspection Cycle

Category	Inspection Timetable				
	Daily	Weekly	Monthly	Quarterly	Yearly
General Checklist					
Check the instrument and the power connection	•				
Check the damage of the power cord	•				
Cleanness of external part		•			
Cleanness of internal part		•			
Cleanness of accessories		•			
System (Control) Related Checklist					
Automatic tuning				•	
Temperature calibration					
Check the temperature offset value					•
Actual temperature/ displaying temperature Calibration					•
Check temperature setting value	•				
Check function of controller				•	
Electric wire related checklist					
Defects if electric wire			•		
Check contamination of electric wire			•		
Check fixation of wiring connection part			•		

CAUTION

- Before using the instrument, please check if there is any other foreign material inside the chamber, and keep it clean.
- Be careful not to damage accessories or systems inside the instrument.
- Be careful not to contact the main body with high concentrations of nitric acid, sulfuric acid, sodium hydroxide or corrosive solvents such as acetone, benzene, phenol, toluene, chloroform, crezol, acetic acid, chloroform. Before using the instrument, please check if there is any other foreign material inside the chamber, and keep it clean.

5.2 Cleaning the Instrument

To keep the instrument in the best condition, to operate it effectively, and to extend its life, it has to be cleaned regularly. It is recommended to check the cleanness daily, clean the internal part weekly, and clean the exterior part monthly.



WARNING

- If the instrument is contaminated from special use, please wipe immediately.
- Since there is a risk of electric shock, please make sure to turn off the power switch and disconnect the plug from the outlet. Also, please wear chemical-resistant gloves.

Please follow the guidelines as shown below.

5.2.1 Cleaning the interior part of the instrument

(1) In general

Step 1: Take out the shelf from the instrument and wipe it with a dry cloth using a neutral detergent.

Step 2: Wipe the inner surface of the instrument with a dry cloth using a neutral detergent.

(2) In case of contaminated

If the device is contaminated with toxic chemicals or toxic gases, please clean it according to the following guidelines.

Step 1: Make sure to wear chemical-resistant gloves and masks.

Step 2: Wipe the contaminated parts of the instrument with a dry cloth.

Step 3: Wipe it with a soft cloth or sponge using a neutral detergent, and then wipe again with a dry cloth.

5.2.2 Cleaning exterior part of the instrument

Step 1: Wipe the exterior surface of the device using a wet soft cloth. If the contamination is severe, wipe with a soft cloth or sponge using a neutral detergent.

Step 2: Wipe it again with a dry cloth.

5.2.3 Cleaning the accessories

Wipe the accessories with a soft cloth or sponge using a neutral detergent, and then with a dry cloth.

CAUTION

- Since there is a risk of electric shock, before cleaning, please turn off the power switch and disconnect the plug from the outlet.
- If the device is contaminated with toxic chemicals or gases, please make sure to wear chemical-resistant gloves and masks when cleaning the interior part.
- Never use chlorine detergent. It may cause the chamber to be oxidized. Also, never use volatile substances such as cleaning agents, abrasives, benzene, acids or solvents.
- Do not wipe the surface of the instrument using an organic solvent such as sulfuric acid or hydrochloric acid.
- Use a soft cloth or a sponge to wash the cleaning tool with a neutral detergent.
- Do not pour water directly into the instrument while cleaning.
- Do not arbitrarily disassemble and clean the instrument.
- If cleaning the instrument in a way other than the above method, please check with Cole-Parmer or the branch before cleaning.

5.3 Major maintenance checks

Please check the confirmation below once again and operate the device correctly.

- (1) Please check the connection between the device and the power source.
- (2) Please check whether the device and system are correctly fixed in the caster.
- (3) Please check whether the up/down, left/right horizontality of the device is correct.
- (4) Please check if there are any flammable or explosive substances left in the device.

WARNING



- Do not arbitrarily disassemble or modify the device other than what is described in this user manual.
- When handling electrical components inside the device, it must be handled only by qualified people.

5.4 Movement and storage

- (1) When moving the instrument, remove the power plug from the outlet.
- (2) Take out everything from the inside of the instrument.
- (3) Before moving the instrument, close the door completely.
- (4) Do not move the instrument by holding the door of the instrument.
- (5) Please pack the equipment, part, and accessories in their original packaging or use appropriate packaging to protect the product during transportation.
- (6) When the instrument is not in use for a long period of time, unplug the power plug, clean it, pack it, and store it in a dry place.



WARNING

- Do not move the instrument with the power cord connected.
- Do not move the instrument while it is in operation.



CAUTION

- Be careful when transporting the instrument since it is heavy. Use the appropriate required tools for transport, and carry it two or more people together.
 - Do not move the instrument while holding the door.
 - Do not cause mechanical shock or vibration during movement or storage of the instrument. Internal damage may cause problems with operation.
 - Disconnect the power plug when the instrument is not in use.
-

6.0 Trouble Shooting

6.1 Trouble Shootings for abnormalities

If an abnormality occurs while using the instrument, please check the following according to the guidelines. If you can't solve the problem even if you check the following or not presented problems, please immediately request the technical service to Cole-Parmer's sales department. If the device is not operating, please check the followings.

- (1) Please check the power connected to the instrument.
- (2) Please check if the START button is pressed.
- (3) Please make sure there is no power outage.

6.2 Power Trouble Shootings for abnormalities

Problem	Cause	Solution
The device does not turn on or has turned off while in use.	<ul style="list-style-type: none"> • The power cord is not connected to the outlet correctly. 	<ul style="list-style-type: none"> • Plug the power cord into the outlet correctly.
	<ul style="list-style-type: none"> • Outlet/ plug/ power cord is damaged. 	<ul style="list-style-type: none"> • Replace the damaged outlet/ plug/ power cord.
	<ul style="list-style-type: none"> • Power supply does not match the equipment's power type. 	<ul style="list-style-type: none"> • Check the voltage, phase and capacity of the power supply and connect the power correctly.
	<ul style="list-style-type: none"> • Either circuit breaker is tripped or there is a power outage. 	<ul style="list-style-type: none"> • If the electrical circuit breaker in the building is tripped, find the cause of the short circuit and fix it.
	<ul style="list-style-type: none"> • Internal circuit failure of the equipment 	<ul style="list-style-type: none"> • Request service.
Circuit breaker in the building keeps tripped.	<ul style="list-style-type: none"> • Too many plugs are connected. 	<ul style="list-style-type: none"> • Remove all the devices connected to the circuit breaker and use within the capacity of the circuit breaker current.
	<ul style="list-style-type: none"> • Internal circuit failure of the equipment 	<ul style="list-style-type: none"> • Request service.
The power turns on but the equipment does not work.	<ul style="list-style-type: none"> • Due to overheating, the protection device cuts off the power. 	<ul style="list-style-type: none"> • When the internal circuit board is overheated, the device automatically shuts off the heater power to protect the internal circuit and emits alarm. • Unplug the power cord and allow the equipment cool, then restart.
	<ul style="list-style-type: none"> • Internal circuit failure of the equipment 	<ul style="list-style-type: none"> • Request service.

6.3 Error Handlings



Problem	Cause	Solution
In case the alarm keep ringing	• Door is opened	• Please check if the door-opened lamp is working, and then close the door.
	• The setting temperature Over temp. limiter is abnormal	• Set the 15% higher temperature of the Over temp. limiter.
In case the temperature does not rise	• Check if the “Run” sign of the status display is blinking (placed on the top part of the controller)	• Press the “Start/Stop” button if the “Run” sign is turned off.
	• Door is opened	• Close the door.
	• Door switch failure	• Open and close the door 2-3 times to check for any abnormality in the door switch. • Request for the technical service.
	• The set set temperature is lower than the current temperature.	• Check the set temperature and enter the temperature you want to use.
	• Timer setting	• Check the Wait on timer
	• Device failure	• Request service.
In case the temperature control is not working	• Please check whether there is any device that generates strong high frequency noise around the instrument.	• Please remove such devices that generate strong high frequency noise.
	• Did not perform Auto tuning	• Execute the Auto tuning
	• Foreign substances or oil may be introduced into the controller	• Request for the technical service.
	• Device failure	• Request service.
In case the abnormal sound	• Fan Failure	• Check if the fan is working normally. • Request for the technical service.
	• Device failure	• Request service.
In case the display is abnormal	• Damage to parts due to external force, chemicals, or overheating	• Request service.
In case the touch does not work well	• Touch with a large area such as your finger or touch with low pressure	• The display of this device is piezoelectric, so touch it with a hard part of your hand, such as your fingernail.

- ※ If parts are needed to be replaced, only pure parts should be used.
- ※ Failure beyond normal limits cannot maintain technical repair.







6.4 Caution and warning alarms

The equipment provides an alarm display function as shown in the table below for Caution and warning. In addition, troubleshooting information is provided in a pop-up window when an error occurs for the convenience of users while using the equipment. Check the message and take action referring to [8.4 Contact Points].

6.4.1 Caution

Problem	Cause	Solution
 High Temp. Deviation	the actual temperature is higher than the set temperature + allowable upper limit temperature	Stop the instrument and restart it after the instrument has cooled down. If the same problem occurs, request service.
 Low Temp. Deviation	the actual temperature is lower than the set temperature – allowable lower limit temperature	Stop the instrument and restart it after the instrument has cooled down. If the same problem occurs, request service.
 Door : Opened	door is open	Check if the door text on the display window is on and close the door securely.

6.4.2 Warning

Problem	Cause	Solution
 Warning : Over Temp.	the temperature is over the absolute upper limit temperature that the device set	Unplug the power cord and restart the device after it cools down.
 Heater Disconnection	there is a problem with the heater or SSR	Request service.
 High Temp.	The temperature of the device is higher than the temperature set in Over Temp Limit.	Set the over temp limiter 15% higher than the current temperature. (Set up to a maximum temperature of 270 degrees)
 Door : Open time exceeded	The door opens longer than the Door Open Alarm Delay time.	Close the door and start the instrument or change the door open delay time setting.
 Temp. Sensor Failure	There is a problem with the temperature sensor.	Request service.
 Board Failure	There is a problem in the temperature detection circuit.	Request service.

7.0 Accessories

7.1 Types of Accessories

Designation	Cat. No.
Wire Shelf for OVF-800-26	52412-31
Wire Shelf for OVF-800-61	52412-32
Wire Shelf for OVF-800-112	52412-33
Wire Shelf for OVF-800-147	52412-34
Perforated Shelf for OVF-800-26	52412-35
Perforated Shelf for OVF-800-61	52412-36
Perforated Shelf for OVF-800-112	52412-37
Perforated Shelf for OVF-800-147	52412-38

8.0 Appendix

8.1 Technical Specification

8.1.1 OVF-800 Series

Item/Model		52412-15 52412-16	52412-17 52412-18	52412-19 52412-20	52412-21 52412-22
Chamber volume (L/cu ft)		26/0.92	61/2.15	112/3.96	147/5.19
Temp.	Range (°C/°F)	Amb. +10 ~ 250/18~482			
	Fluctuation at 100°C (°C/°F)	±0.3/0.54	±0.3/0.54	±0.3/0.54	±0.3/0.54
	Variation at 100°C (°C/°F)	±1.4/2.52	±1.9/3.42	±1.7/3.06	±1.5/2.7
	Heating time to 100°C (min.)	8	10	14	15
	Recovery time at 100°C (min.)	4	4	4	4
	Controller	Microprocessor PID			
	Sensor	PT 100			
	Heater (SUS 304, 230VAC/120VAC, W)	1400			
Controller functions		Auto tuning, 3-point temp. calibration, Wait on / off timer(99hr 59min), Auto-run			
Safety		CLS(Custom Logical Safe)-control system, IEC protection Class II, Over temp. limit			
Control panel		3.5inch TFT Color LCD			
Communication interface		USB, RS-232 (Option)			
Material	Internal	Stainless steel			
	External	Steel, 0.8t powder coating			
	Shelves	Stainless steel wire, electro polished			
	Insulation	Mineral wool			
	Ventilation slide	Stainless steel, dia 38mm x 1ea			
Dimensions	Interior (W x D x H, mm/inch)	300x210x400/ 11.8x8.27x15.75	380x330x480/ 14.97x13.0x18.9	485x350x655/ 19.1x13.78x25.79	550x376x710/ 21.65x14.8x28.0
	Exterior (W x D x H, mm/inch)	478x527x604/ 18.8x20.75x23.78	558x648x684/ 21.97x25.5x26.93	663x677x859/ 26.1x26.65x33.82	728x704x914/ 28.66x27.7x36.0
	Shelves (standard / max)	2/4	2/5	2/8	2/9
Electric requirements (VAC, Hz, A)		230VAC, 50/60Hz, 6.4A * 120VAC, 60Hz, 12.3A			
Electric consumption (Wh)		40 (at 100°C) 790 (at 250°C)	60 (at 100°C) 810 (at 250°C)	70 (at 100°C) 1090 (at 250°C)	80 (at 100°C) 1240 (at 250°C)
Max. load per shelf (kg)		30			
Noise Level (dB)		48			
Number of Air change per hour at 100°C		123	22	18	11
Weight (net, kg)		33/72.8	53/116.8	63/138.9	73/160.9
Permissible ambient temperature (°C)		5 – 40/41-104			
Permissible relative humidity (%)		10 - 80			

※ The above specifications are subject to change without individual notice due to product quality and performance improvement.

※ CE Models: 230 VAC, 50/60 Hz models fulfill the requirements of relevant European product directives

8.2 Disposal of Product

Before disposing a product or its component, please be aware of the followings.



- (1) This product is potentially hazard when exposed to biological, chemical, or radioactive materials, so it must be cleaned up to protect disposal personnel, waste collectors, and environment.
- (2) Please contact a person who is in charge of disposing of the products to check the electrical, electronic and material disposal standards. When you request externally, it is recommended that you contact to your company's vendor or a testing equipment manufacturer that can properly dispose the laboratory equipment and its components.

8.3 Warranty

8.3.1 Warranty period

- (1) If the product fails during normal and proper use, the warranty period for manufacturing liability shall be two years from the date of purchase.
- (2) If you request a repair, please check the items below and let us know so that you can get a quicker and more accurate repair.

- | |
|--|
| <ul style="list-style-type: none">• Date of purchase:• Customer name / address / phone number / E-mail:• Fault status: |
|--|

8.3.2 Warranty Exception

Paid repairs are carried out even within the warranty period in the following cases:

- | |
|---|
| <ul style="list-style-type: none">• Failure due to improper use by the user• Failure due to improper handling and storage by the user• Improper use, modification, or repair of the product• Failure caused by natural disasters such as fire, flood, or abnormal voltage, etc.• Fault caused by not following the instructions of user manuals |
|---|

8.3.3 How to Request for the Customer Service

Customers have always been at the center of what we do, and we have always looked at things from the customer's perspective. If you find out any problems with your product, please fill out the service application form listed below and submit it to the head office or your dealer for quick and accurate repair.

- (1) Date of Purchase
- (2) Customer/ Address/ Telephone Number / E-mail address
- (3) Product Serial Number (it is on the ID plate, on the side of the product)
- (4) Problem Details of the Product

If you would like to purchase any product accessories, please contact the following branch office or head office.

8.3.4 Returning Process of the Product

If you need to return the product due to damages during the transportation or any other reasons, please receive the return authorization number from the distributor you purchased. When returning the product, please fill out the return form with the following details and send it to the head office or to the distributor you purchased.

- (1) Date of Purchase
- (2) Customer name / address / telephone number / E-mail
- (3) Product serial number (it is on the ID plate, on the side of the product)
- (4) Transport company's information
- (5) Return authorization number
- (6) Reasons for Returning

8.4 Contact Points

Warranty Registration



UK

T: +44(0) 1480 272279
E: uk.sales@antylia.com
W: coleparmer.co.uk

Germany

T: +49 (0) 9377 92030
E: de.sales@antylia.com
W: coleparmer.de

France

T: +33 (0) 1486 37800
E: fr.sales@antylia.com
W: coleparmer.fr

Italy

T: +39 (0) 284349215
E: it.sales@antylia.com
W: coleparmer.it

India

T: +9122 61394444
E: info@coleparmer.in
W: coleparmer.in

China

T: +1 847 549 7600
E: sales@antylia.com
W: coleparmer.com

USA

T: +1 847 549 7600
E: sales@antylia.com
W: coleparmer.com

Canada

T: +514 355 6100
E: info@antylia.ca
W: coleparmer.ca

Other

T: +1 847 549 7

Cole-Parmer®

Antylia Scientific Ltd.
625 East Bunker Court,
Vernon Hills,
IL 60061.
USA

