



# Ultra-Low Temperature Freezers Revco™ RDE Series, Forma™ FDE Series, HERAfreeze™ HDE Series and Thermo Scientific™ TDE Series

## Installation and Operation

329712H01 • Revision H • December 2022

**IMPORTANT** Read this instruction manual. Failure to follow the instructions in this manual can result in damage to the unit, injury to operating personnel, and poor equipment performance.

**CAUTION** All internal adjustments and maintenance must be performed by qualified service personnel.

Material in this manual is for informational purposes only. The contents and the product it describes are subject to change without notice. Thermo Fisher Scientific makes no representations or warranties with respect to this manual. In no event shall Thermo be held liable for any damages, direct or incidental, arising from or related to the use of this manual.

© 2022 Thermo Fisher Scientific Inc. All rights reserved.

# Contents

Models.....	1
Safety Considerations .....	2
Unpacking .....	3
Packing List .....	3
General Recommendations.....	4
Temperature Monitoring .....	4
General Usage .....	4
Initial Loading .....	4
Battery Door Opening/Closing.....	4
Operating Standards.....	5
Electrical Specifications .....	5
Installation.....	6
Location .....	6
Protective Conductor Current.....	6
Leveling.....	6
Ice Scraper .....	6
Backup System (Optional) .....	7
Super Insulated Cabinet Construction .....	7
Door Operation .....	7
Pressure Equalization Port.....	7
Installing the Remote Alarm Connector.....	8
Intended Use.....	8
Operation.....	9
Initial Start Up.....	9
Operation Overview .....	9

Display .....	9
Settings.....	10
Power Down .....	11
Ice Scraper Instructions .....	12
Intended Use.....	12
Unintended Use .....	12
Precautions and Usage .....	12
Backup System (Optional).....	13
CO <sub>2</sub> and LN <sub>2</sub> Precautions .....	13
Installation .....	13
Start Up .....	14
Operation.....	14
Chart Recorders (Optional).....	15
Set Up and Operation .....	15
Changing Chart Paper.....	15
Calibration Adjustment .....	15
Maintenance .....	16
Cleaning the Condenser.....	16
Cleaning the Condenser Filter.....	16
Gasket Maintenance .....	16
Defrosting the Freezer .....	16
Battery Maintenance .....	16
Maintenance Schedule.....	17
Troubleshooting Guide.....	18
Error Codes .....	21
Warranty .....	22
Warranty (International) .....	23

Appendix A: Alarm Summary .....	24
Appendix B: Modbus ASCII Parameter Table .....	26
WEEE Compliance .....	37
Contact Information .....	39

# Models

Table 1. Applicable Models

Brand - Model	Size (xxx)	Voltage (*)	Energy star model (*)	
Forma - FDExxx86F*	300/400/500/600	A/D/V	-	
Forma - FDExxx86F* - ULTS	300/400/500/600	A/D/V	-	
Thermo Scientific –TDExxx86F*	300/400/500/600	A/D/V	600A/600D	
Thermo Scientific –TDExxx86F*- ULTS	300/400/500/600	A/D/V	-	
HERAfreeze – HDExxx86F*	300/400/500/600	A/D/V	-	
Revco - RDExxx86F*	300/400/500/600	A/D/V	-	

**Note:** Only TDE60086F model A/D voltage are Energy star models.

# Safety Considerations

In this manual, the following symbols and conventions are used:



This symbol used alone indicates important operating instructions which reduce the risk of injury or poor performance of the unit.



**CAUTION:** This symbol, in the context of a CAUTION, indicates a potentially hazardous situation which if not avoided could result in minor to moderate injury or damage to the equipment.



**WARNING:** This symbol indicates potentially hazardous situations which, if not avoided, could result in serious injury or death.



**WARNING:** This symbol indicates situations where dangerous voltages exist and potential for electrical shock is present.



The snowflake symbol indicates extreme low temperatures and high risk of frostbite. Do not touch bare metal or samples with unprotected body parts.



This symbol indicates a need to use gloves during the indicated procedures. If performing decontamination procedures, use chemically resistant gloves. Use insulated gloves for handling samples and when using liquid nitrogen.



Before installing, using or maintaining this product, please be sure to read this manual and product warning labels carefully. Failure to follow these instructions may cause this product to malfunction, which could result in injury or damage.

Below are important safety precautions that apply to this product:



Use this product only in the way described in the product literature and in this manual. Before using it, verify that this product is suitable for its intended use. If this equipment is used in a manner not specified by the manufacturer, the protection provided by the equipment may be impaired.



Do not modify system components, especially the controller. Use OEM exact replacement equipment or parts. Before use, confirm that the product has not been altered in any way.



**WARNING:** Your unit must be properly grounded in conformity with national and local electrical codes. Never connect the unit to overloaded power sources.



**WARNING:** Disconnect the unit from all power sources before cleaning, troubleshooting, or performing other maintenance on the product or its controls.



**WARNING:** "Caution, risk of fire". This unit is charged with hydrocarbon refrigerants.

## EMC (where applicable)

EMC Registration is done on this equipment for business use only. It may cause interference when the product would be used in home.

사용자 안내문 이 기기는 업무용 환경에서 사용할 목적으로 적합성평가를 받은 기기로서 가정용 환경에서 사용하는 경우 전파간섭의 우려가 있습니다.

This equipment has been tested and found to comply with the limits for a Class A digital device. Class A covers devices for usage in all establishments other than domestic and that are not directly connected to a low voltage power supply network, which supplies domestic environment.

This ISM device complies with Canadian ICES-001.

## FCC (where applicable)

This equipment has been tested and found to comply with the limits for a Class A digital device, pursuant to part 15 of the FCC Rules. These limits are designed to provide reasonable protection against harmful interference when the

equipment is operated in a commercial environment. This equipment generates, uses, and can radiate radio frequency energy and, if not installed and used in accordance with the instruction manual, may cause harmful interference to radio communications. Operation of this equipment in a residential area is likely to cause harmful interference in which case the user will be required to correct the interference at his own expense.

# Unpacking

At delivery, examine the exterior for physical damage while the carrier's representative is present. If exterior damage is present, carefully unpack and inspect the unit and all accessories for damage.

If there is no exterior damage, unpack and inspect the equipment within five days of delivery. If you find any damage, keep the packing materials and immediately report the damage to the carrier. Do not return goods to the manufacturer without written authorization. When submitting a claim for shipping damage, request that the carrier inspect the shipping container and equipment.

The packaging can be stored and re-used.

## Packing List

Inside the freezer cabinet is a bag containing:

- A handle lock key
- To download the complete Installation and Operation Manual for the unit, please visit: <https://www.thermofisher.com/usermanuals>
- Certificates of conformance and calibration as required
- A remote alarm contact connector
- Posts for rear spacing
- Ice Scraper & Magnetic hook (optional)

If you have ordered a chart recorder, the bag will also contain:

- Recorder installation instructions
- Extra paper

If you have ordered a backup system, the cabinet will also contain:

- A hose assembly
- English and metric connectors

If specified on the order, the bag may also include:

- A QC temperature graph and test log
- Calibration information



# General Recommendations

## Temperature Monitoring



**IMPORTANT NOTE:** Thermo Fisher Scientific recommends the use of a redundant and independent temperature monitoring system so that the freezer can be monitored continuously for performance commensurate with the value of product stored.

## General Usage

This refrigeration system is designed to maintain ultra-low temperatures with safety in an ambient environment within 15°C to 32°C (59°F to 90°F), only when the freezer is used for storage.



**WARNING:** This unit is not a “rapid-freeze” device. Freezing large quantities of liquid, or high-water content items, will temporarily increase the chamber temperature and will cause the compressors to operate for a prolonged time period.

Avoid opening the door for extended time periods since chamber temperature air will escape rapidly. Also, keep the inner doors closed as much as possible. When room air, which is higher in humidity, replaces chamber air, frost may develop in the chamber more rapidly.

## Initial Loading

**Allow the freezer to operate at the desired temperature for a minimum of 12 hours before loading.**

Load the freezer one shelf at a time, beginning with the top shelf. After loading each shelf, allow the freezer to recover to the desired set point before loading the next shelf. Repeat this process until the freezer is fully loaded.



**CAUTION:** Failure to follow these procedures or overloading the unit may cause undue stress on the compressors or jeopardize user product safety.

## Battery Door Opening/Closing

To open the grille door, pull the door from the top right corner as shown in the figure below.

To close the grille door, push the door against frame to hold latch in position.



**Figure 1. Door Opening**

# Operating Standards

The freezers described in this manual are classified for use as stationary equipment in a Pollution Degree 2 and Over voltage Category II environment.

These units are designed to operate under the following environmental conditions:

- Indoor use
- Altitude up to 2000 m
- Maximum relative humidity 60% for temperatures within 15°C to 32°C (59°F to 90°F)
- Main supply voltage fluctuations not to exceed  $\pm 10\%$  of the nominal voltage for 115 V/60 Hz & 220-230 V/50 Hz.
- Main supply voltage fluctuations not to exceed -10% or +6% of the nominal voltage for 208-230 V/60 Hz.

## Electrical Specifications

The last character in the model number listed on the data-plate identifies the electrical specifications for your unit. Specific unit current rating is listed on the data-plate.

The voltage types are A, D and V as specified in the following table:

**Table 2. Electrical Specifications by Size and Voltage**

Size/ Voltage	Voltage	Frequency	Current*
300A	115 V	60 Hz	15.25 A
300D	208-230 V	60 Hz	7.2 A
300V	220-230 V	50 Hz	7.1 A
400A	115 V	60 Hz	16.7 A
400D	208-230 V	60 Hz	7.6 A
400V	220-230 V	50 Hz	6.5 A
500A	115 V	60 Hz	16.7 A
500D	208-230 V	60 Hz	7.6 A
500V	220-230 V	50 Hz	6.5 A
600A	115 V	60 Hz	16.7 A

**Table 2. Electrical Specifications by Size and Voltage**

600D	208-230 V	60 Hz	7.6 A
600V	220-230 V	50 Hz	6.5 A

\*Values subject to change

**Note:** Only TDE60086 size A/D voltage are Energy star models.

# Installation



**WARNING:** Do not exceed the electrical rating printed on the data plate located on the lower left side of the unit.

## Location

Install the unit in a level area free from vibration with a minimum of 8" (20 cm) of space on the top and sides, 6" (15 cm) in back. Refer to **Leveling** for further instructions on leveling cabinets. Allow enough clearance so that door can swing open at least 85°.

The rear spacing posts provided with the freezer can be used to ensure proper clearance. To install the spacing posts, screw them into the back side of the unit, in the rear deck area.

Do not position the equipment in direct sunlight or near heating diffusers, radiators, or other sources of heat. The ambient temperature range at the location must be 15°C to 32°C (59°F to 90°F).

## Protective Conductor Current

The maximum limit of 10 mA shall not be exceeded when tested according to Clause 5.5 (Measurement of protective conductor current) of EN 50678 or DIN VDE 0701-1 or DIN EN 50678 VDE 0701.

## Wiring



**CAUTION:** Connect the equipment to the correct power source. Incorrect voltage can result in severe damage to the equipment.



**CAUTION:** For personal safety and trouble-free operation, this unit must be properly grounded before it is used. Failure to ground the equipment may cause personal injury or damage to the equipment. Always conform to the National Electrical Code and local codes. Do not connect the unit to overloaded power lines.



**CAUTION:** Do not position the unit in a way that impedes access to the disconnecting device or circuit breaker in the back of the unit.



**CAUTION:** Always connect the freezer to a dedicated (separate) circuit. Each freezer is equipped with a service cord and plug designed to connect it to a power outlet which delivers the correct voltage. Supply voltage must be within  $\pm 10\%$  of the freezer rated voltage for 115 V/60 Hz & 220-230 V/50 Hz. Supply voltage must be within  $-10\%$  to  $+6\%$  of the freezer rated voltage for 208-230 V/60 Hz. If cord becomes damaged, replace with a properly rated power supply cord.

**Table 3. Power Cord Specification**

Model	Power Cord Specification
A	3-G 12 AWG, NEMA 5-20P, 20A/125V
D	3-G 12 AWG, NEMA 6-15P, 15A/250V
V	3-G 1.5 mm <sup>2</sup> , CEE 7/7, 16A/250V



**CAUTION:** Never remove or disable the grounding prong from the service cord plug. If the prong is removed, the warranty is invalidated.

## Leveling

Make sure that the floor is level. The unit must be level both front to back and side to side.

The 300 and 400 box capacity models are equipped with one or two leveling legs on the right hand side. Leveling legs on 300 size must be used as a safety precaution.

Ensure to lock the brakes for units equipped with casters.

## Ice Scraper

- Remove the packing and make sure the scraper and magnetic hook are in good condition, if included.
- Do not use a damaged scraper as it may cause injury.
- Use the magnetic hook to hang the scraper on the unit for convenience. The magnetic hook should be placed in the recommended area on either side of the unit as shown in **Figure 2**.



**Figure 2. Ice Scraper**

## Backup System (Optional)

If you are using a CO<sub>2</sub> or LN<sub>2</sub> backup system, refer to **Backup System (Optional)** for installation and operation instructions.

## Super Insulated Cabinet Construction

In all models, the cabinet walls have a vacuum insulation core encapsulated by a sealed film laminate.



**CAUTION:** Never drill holes in or near the cabinet walls. Drilling could damage the insulation and make the unit inoperable.

## Door Operation

Upright freezer models are equipped with an advanced assembly specifically designed for ultra-low temperature freezers.

Features include:

- One-hand operation

- A front-accessible lock
- Hasps for a standard padlock to provide additional security. Length of the shackle must be between 3/4" (1.9 cm) and 1 1/2" (3.8 cm)
- Durable construction for reliable operation and safe product storage
- Door ramp alignment feature



**CAUTION:** When moving the freezer, always grasp cabinet surfaces; never pull the freezer by the latch handle.

## Opening the Door

1. Remove the padlock if installed.
2. Grasp the latch handle and pull it toward yourself until the latch disengages.
3. Keep pulling by the latch handle to open the main door.

## Closing the Door

**Note:** The latch does not self-engage automatically when you close the door. You must rotate the latch into the open position first.

1. Grasp the latch handle and pull it toward yourself, rotating the latch into the open position.
2. Move the freezer door into the closed position and gently push the handle away from you, making sure that the latch engages fully with the cabinet strike.
3. Keep applying gentle pressure to the latch handle until the latch is securely in closed position.
4. Insert the key and rotate counterclockwise to lock.
5. Replace the padlock as required.

## Pressure Equalization Port

When an upright ultra-low temperature freezer door is opened, room temperature air rushes into the storage compartment. When the door is closed, the fixed volume of air is cooled rapidly. Pressure drops below atmospheric pressure, resulting in a substantial vacuum. Re-entry into the cabinet is impossible until internal pressures are returned to atmospheric pressure. Without a pressure equalization mechanism, it can take, in extreme cases, several hours before the door can easily be reopened.

All upright models feature a port that provides vacuum relief after door openings. The pressure equalization port is located in the door behind the eye-level panel on the front of the freezer.

Although the port is heated and designed to self-defrost, excessive frost accumulation on the inner door could eventually restrict air flow. Therefore, you should periodically inspect the inner door and brush away any loose frost using a stiff nylon brush.

This unit is not intended for use in classified hazardous locations, nor to be used for the storage of flammable inventory.

## Installing the Remote Alarm Connector

The remote alarm contacts are located on the back of the freezer above and to the left of the power switch. After installing the wiring from the remote alarm to the connector, install the connector to the freezer micro-board.

The pin configuration is shown in Figure 2 below.

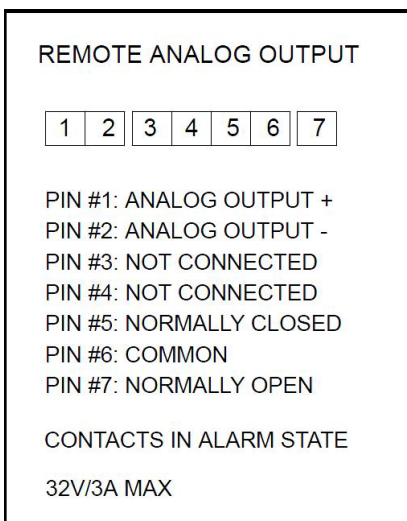

**Figure 3. Remote Alarm Pin Configuration**

*For systems that alarm in closed state, connect to pins 5 & 6.*

*For systems that alarm in open state, connect to pins 6 & 7.*

The contacts will trip in the event of a power outage, high temperature alarm, low temperature alarm or door ajar alarm.

## Intended Use

The  $-86^{\circ}\text{C}$  freezer (refer to **Models** for the specific model series) described in this manual are high performance units for professional use. These products are intended for use as cold storage in research use and as a general purpose laboratory freezer, storing samples or inventory at operating temperatures between  $-50^{\circ}\text{C}$  and  $-80^{\circ}\text{C}$ .

It is not considered a medical device and has therefore not been registered with a medical device regulatory body (e.g., FDA): that is, it has not been evaluated for the storage of samples for diagnostic use or for samples to be re-introduced to the body.

# Operation

## Initial Start Up

To start the freezer, complete the following steps:

1. Plug the freezer into the power outlet.
2. Turn the power switch ON. You can find the switch in back of the freezer, on the bottom right.
3. Once the freezer is turned ON, the user interface will begin a start up procedure. Once ready for operation, the temperature is displayed on the screen.

## Operation Overview

Once you have successfully completed the initial start up procedures, the freezer starts operating normally and the only actions required are:

- Setting the operating and alarm set points.
- Activating the CO<sub>2</sub> or LN<sub>2</sub> backup system if installed. For instructions on backup settings and activating the system, refer to **Backup System (Optional)**.





## Display

The display screen below is the default screen.







Figure 4. Display

The control panel consists of the 5 touch-point buttons located on the right side of the display.

1.  **Alarm Bell** – This icon indicates visual and audible alarm that accompanies various alarm states. Pressing the alarm bell while in an alarm state will snooze the audible alarm for 10 minutes.
2.  **Plus** – Increases the value of the selected setting.
3.  **Check Mark** – Saves a change to the selected value.
4.  **Minus** – Decreases the value of the selected setting.
5.  **Settings** – The settings icon represents the various settings including:

- Warm Alarm value - The range of the warm alarm temperature is  $-40^{\circ}\text{C}$  to within  $5^{\circ}\text{C}$  of setpoint.  
**Note :** The warm alarm will be disabled for 12 hours from a warm start condition.
- Cold Alarm value - The range is  $-99^{\circ}\text{C}$  to within  $5^{\circ}\text{C}$  of setpoint.  
**Note :** A setpoint change may automatically change the warm/cold alarm setpoints as well to maintain a minimum  $5^{\circ}\text{C}$  separation from the control setpoint.
- **Offset value** - This is used for calibration. Range is  $-10^{\circ}\text{C}$  to  $+10^{\circ}\text{C}$ . Default is 0.  
*Entering a positive offset value will yield a colder cabinet temperature.*  
*Entering a negative offset value will yield a warmer cabinet temperature.*
- **Setpoint security code** – This code is a 3-digit numeric code. Refer to **Setpoint Security**.
- **Backup system type** (if backup system is installed) – Set the type to either LN<sub>2</sub> or CO<sub>2</sub> corresponding to the backup system that is installed.
- **Backup system setpoint** (if backup system is installed) - This setpoint indicates the temperature at which the backup system will begin cooling the cabinet. It is recommended to set the backup system setpoint at a minimum of  $10^{\circ}\text{C}$  warmer than the control setpoint. For more information, refer to **Backup System (Optional)**.

The message panel on the top indicates freezer health status and the various alarm or warning states.

1.  **Wrench** – This is a generic service warning which corresponds to an intermittent flashing error code displayed on the screen. Refer to **Error Codes** for a list of error codes.
2.  **Door** – This icon will illuminate during a door ajar alarm. A door open for more than 3 minutes will result in an audible door ajar alarm.
3.  **Heart** – The heart is the health status for the freezer. A green heart indicates normal freezer operation. In an alarm state, this icon is not illuminated.
4.  **Thermometer** – This indicates when the cabinet temperature exceeds either warm alarm or cold alarm setpoints and the audible alarm will occur.
5.  **Snooze Bell** – This is only illuminated during an active alarm that has been silenced by the user.

## Settings

If setpoint security is enabled, you must first enter the security code to make any setpoint changes. Refer to **Setpoint Security** to adjust setpoint security.

## Control Setpoint

To modify the control temperature setpoint:

- Press the plus or minus button while displaying unit temperature (“Actual” is illuminated). The control setpoint is displayed
- Adjust setpoint to desired temperature
- Select the checkmark button to save the new control setpoint.

## Other Setpoints and Settings

- Press the settings button to enter Settings menu
- Continue pressing the settings button until the desired setting is illuminated on lower horizontal panel. (If backup system is installed, CO<sub>2</sub> or LN<sub>2</sub> is displayed after pressing the settings button 5 times.)
- Adjust the setting to desired temperature or value using the plus or minus buttons

- Press the checkmark button to save the new temperature or value
- After the value is saved, display will show the next option in the settings menu.

To return to the unit temperature display:

- Press the settings button until unit temperature is displayed (“Actual” is illuminated)
- If there is no activity after 5 minutes, the unit will automatically return to the temperature display.

## Warm Alarm Test

Press the plus and checkmark buttons at the same time to initiate the warm alarm test. During the warm alarm test, the actual cabinet temperature will not be displayed. The display temperature will increase. Once the display temperature reaches the warm alarm setpoint, the alarm is activated. After 5 seconds, the test will automatically end and the display will return to the actual cabinet temperature.

## Setpoint Security

- To adjust setpoint security in the settings menu, press the settings button 4 times
- The setpoint security code consists of 3 digits, each of which must be set in sequence from left to right
- Use the plus or minus button to adjust each value, and the checkmark button to save each value of the 3-digit security code



- If you forget the setpoint security code, contact customer support.



# Power Down

To power down the ULT, first turn the breaker switch, located at the rear of the freezer, to the off position. Once the switch is in the off position, the display will show “OFF” followed by “YES” and then “NO” in 2 second intervals. The checkmark will also be illuminated while “YES” and “NO” are showing. Press the checkmark while “YES” is showing. With a flashing “YES”, you are required to confirm by pressing the checkmark button a second time. Power down will then be complete.

If the checkmark button is pressed while “NO” is illuminated or if no action is taken for 5 minutes, this is interpreted as a power failure. In this case, the user interface will stay on (using battery power only) and an audible alarm will sound to indicate power failure. If installed, the backup system will remain active and inject per the backup system settings.



# Ice Scraper Instructions

## Intended Use

The ice scraper is used to scrape any frost accumulated on the cabinet breaker and other hard surfaces inside the freezer.

It is recommended that the ice scraper is used every month to obtain the best performance of the freezer.

To help minimize ice build-up, try to move samples in and out as quickly as possible.



**CAUTION:** Do not misuse the scraper for any purpose other than the intended use.



**CAUTION:** The manufacturer cannot be responsible for any damages deriving from improper, wrong or incautious use.

## Unintended Use

The ice scraper should not be used as any other tool and for any other purpose except for scraping hard surfaces.

Do not use the scraper as a tool to open the door before the PEP time expires.

## Precautions and Usage

Read the following instructions carefully, since they provide useful safety information about installation, use and maintenance to help avoid mishaps and possible accidents.

- Remove the packing and make sure the scraper and magnetic hook are in good condition, if included.
- Do not use a damaged scraper as it may cause injury.
- Use the magnetic hook to hang the scraper on the unit for convenience. The magnetic hook should be placed in the recommended area on either side of the unit as shown in **Figure 2**.
- Use the scraper provided with your equipment to scrape the ice or frost formed on the cabinet breaker and other hard surfaces inside the freezer.
- To prevent gasket damage, do not use the scraper on the gasket.
- To remove the ice from the gasket, refer to the **Gasket Maintenance** section.

# Backup System (Optional)

For all ultra-low temperature cold storage products, we recommend the use of a backup system (BUS) for the security of your samples.

When you purchase a built-in CO<sub>2</sub> or LN<sub>2</sub> optional backup system for the freezer, backup control is integrated into the main user interface.

**Note:** For stand-alone backup systems, refer to installation instructions provided with the backup system kit.



**Note:** Always purchase the cylinders which are equipped with siphon tubes for withdrawing liquid from the bottom of the cylinder. CO<sub>2</sub> cylinders must be kept at room temperature to function properly. LN<sub>2</sub> bottles are functional at any reasonable temperature.



**CAUTION:** When closing the cylinder valve, make sure that the injection solenoid is energized to allow all the liquid to bleed off instead of being trapped in the supply hose. Failure to do this results in activation of the pressure relief device, which could damage the freezer and requires replacing if it is activated.



**CAUTION:** For models ordered with factory installed built-in backup systems, the flow of liquid CO<sub>2</sub> or LN<sub>2</sub> will be discontinued if the door is opened during operation of the backup system. For units operated with free-standing, field installed type backup system, the flow of liquid CO<sub>2</sub> or LN<sub>2</sub> will be discontinued upon door opening only if the switch provided with the free-standing package is installed on the freezer.

## CO<sub>2</sub> and LN<sub>2</sub> Precautions

The following are precautions for using liquid CO<sub>2</sub> and LN<sub>2</sub> backup systems.



**WARNING:** If a CO<sub>2</sub> or LN<sub>2</sub> cylinder falls and a valve is knocked off, the cylinder becomes a deadly and completely unguided missile. Transport the cylinders in a hand-truck or cart with secure chain ties for the cylinder. After cylinders are connected to the equipment, securely attach them with chains to a solid stationary object such as a building column.



**WARNING:** CO<sub>2</sub> and LN<sub>2</sub> liquids are non-poisonous but are very cold and will burn unprotected skin. Always wear protective eye wear and clothing when changing cylinders or working on the piping systems attached to an active source of liquid refrigerant.



**WARNING:** The gases produced by evaporation of CO<sub>2</sub> or LN<sub>2</sub> are non-poisonous but displace the oxygen in a confined space and can cause asphyxiation. Do not store the cylinders in subsurface or enclosed areas.

## Installation

Field installed systems are supplied with complete installation and operating instructions. If your system is factory installed, the freezer is shipped with a coiled length of hose to connect the freezer to the bottles:

- 1/4" Flexible Hose with fittings for connection to the CO<sub>2</sub> supply.
- 1/2" Flexible Hose with fittings for connection to the LN<sub>2</sub> supply.

To install,

1. Straighten the coiled hose.
2. Connect one end to the labeled connection on the freezer.
- Tighten the nut two flats past finger tight, approximately 120 degrees.

**Note:** For CO<sub>2</sub>, remove the threaded fitting from the nut on the end of the copper tubing to access nut for connection to the freezer. Discard the threaded fitting.

3. Attach the other end to the supply bottle or building supply fitting.
- For CO<sub>2</sub>:
  - Remove Nipple from adapter (NPT Connection). Remove cable tie to release alternative nut and washer. Ensure the correct nut fitting is supplied over the nipple (US or European).

- Add 2 wraps of Teflon tape clockwise to the 1/4" NPT fitting (on the nipple) when viewed from the threads. Tighten the NPT fittings approximately 2 turns from finger tight (approximately 720°).

**Note :** The top of the nipple has a hex configuration, allowing for use of a wrench when the nut is pulled down.

- Add washer to nipple inside of nut (unless CO<sub>2</sub> supply has a built in washer).

**Note :** Small raised area of washer fits into groove of nipple. The washer will feel snug when trying to shift side-to-side on nipple. The washers are designed for a limited number of attachments/disconnections from the supply and may wear over time. If washer appears worn and causes CO<sub>2</sub> leakage, replace washer (Part Number 45705H03).

- Wrench tighten the supply nut to the supply.
- For LN<sub>2</sub>:
  - Attach the fitting to the supply and wrench tighten.

**Note:** Do not twist, torque, or subject the flexible hose to sharp bends. Doing so may shorten the life of the hose.

## Operation

The backup system can run for a minimum of 24 hours on battery power.

On average, a backup system in operation uses 8 to 10 lbs. per hour of CO<sub>2</sub> (3.6 to 4.5 L/hr) or LN<sub>2</sub> (4.5 to 5.6 L/hr) at an ambient temperature of 25°C.

This rate will vary depending on set point, load, ambient temperature and freezer size.

## Start Up

When the unit is started, it will recognize if a backup system is installed.

1. Follow the instructions in **Backup System (Optional)** to set the backup system type and setpoint.
2. It is recommended to test backup system operation prior to sample storage.

## Test BUS Operation

After the freezer has stabilized and both batteries are fully charged, the BUS can be tested to verify proper operation.

1. Disconnect the AC power to the freezer by turning the power switch off.
2. As the freezer warms up, verify the BUS injects at the desired temperature. Displayed temperature may vary by a few degrees from injection temperature due to the differences in probe locations.

**Note:** On a monthly basis, it is recommended to test your backup system, check the supply tank system levels, and check the backup battery voltage.

# Chart Recorders (Optional)

Panel-mounted six-inch seven-day recorders are available as options for all freezer models except for the smaller 300 box capacity models.



**CAUTION:** Do not use sharp or pointed objects to depress the chart buttons. This may cause permanent damage to the recorder.

## Set Up and Operation

To prepare the recorder to function properly, complete the following steps:

1. Open the grille door to access the recorder.
2. Install clean chart paper (refer to **Changing Chart Paper**).
3. Remove the plastic cap from the pen stylus or ink pen and close the recorder door.

Recorder operation begins when the system is powered on. The recorder may not respond until the system reaches temperatures within the recorder's range.

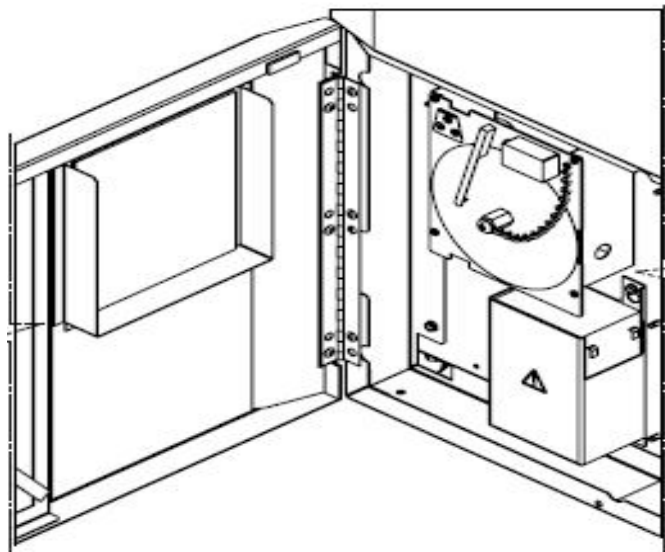

**Figure 5. Chart Recorder**

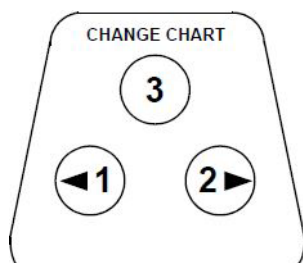

**Figure 6. Chart Buttons**

## Changing Chart Paper

To change the chart paper, complete the following steps:

1. Locate the pressure sensitive buttons at the front, upper left of the recorder panel.
2. Press and hold the Change Chart button (#3) for one second. The pen will move off the scale.
3. Unscrew the center nut, remove the old chart paper, and install new chart paper. Carefully align the day and time with the reference mark (a small groove on the left side of the recorder panel).
4. Replace the center nut and hand tighten. Press the Change Chart button again to resume temperature recording.

## Calibration Adjustment

This recorder has been accurately calibrated at the factory and retains calibration even during power interruptions. If required, however, adjustments can be made as follows:

1. Run the unit continuously at the control set point temperature. Continue steady operation for at least two hours to provide adequate time for recorder response.
2. Measure cabinet center temperature with a calibrated temperature monitor.
3. Compare the recorder temperature to the measured cabinet temperature. If necessary, adjust recorder by pressing the left (#1) and right (#2) chart buttons.

**Note:** The stylus does not begin to move until the top center button (#3) is held for five seconds.

# Maintenance



**WARNING:** Unauthorized repair of your freezer will invalidate your warranty. Contact Technical Service. See **Contact Information** for phone numbers.



**CAUTION:** Maintenance should only be performed by trained personnel.

## Cleaning the Condenser

Clean the condenser at least every six months; more often if the laboratory area is dusty.

To clean the condenser, complete the following steps:

1. Pull the grille door open.
2. Vacuum the condenser.
3. Inspect the filter cleanliness and clean as required.
4. Close the grille door.

## Cleaning the Condenser Filter

Clean the condenser filters every two or three months.

1. Pull the grille door open.
2. Remove the filter.
3. Shake the filter to remove loose dust, rinse the filters in clean water, shake the excess water from the filter, and replace the filter.
4. Close the grille door.

## Gasket Maintenance

Periodically check the gaskets around the door for punctures or tears. Leaks are indicated by a streak of frost which forms at the point of gasket failure. Make sure that the cabinet is level (refer **Leveling** for leveling information).

Keep the door gaskets clean and frost free. Wipe with a soft cloth or cryo-gloved hand. If needed, a rubber mallet may be gently used to loosen ice.

## Defrosting the Freezer

Defrost the freezer once per year or whenever the ice buildup exceeds 3/8". To defrost, complete the following steps:

1. Remove all products and place in another ULT freezer.
2. Turn off the freezer.
3. Open the outer door and all inner doors.
4. Let the freezer stand with doors open for at least 24 hours. This allows both the interior and foamed refrigeration system to warm to room temperature.
5. Dispose of the ice and wipe out any water standing in the bottom of the cabinet.
6. If there is freezer odor, wash the interior with a solution of baking soda and warm water.
7. Clean the exterior with any common household cleaner.
8. Close the doors, restart the freezer and reload. Refer **Initial Loading** to follow the instructions.

## Battery Maintenance

The freezer monitors the voltage status of the battery daily and indicates the battery's voltage via visual and auditory alarm. Replace the battery as indicated by system alarms or as necessary per individual status evaluation. Check the battery connections regularly. Although not required, annual battery replacement is recommended to ensure proper battery status in the event of power failure.

For safety, it is recommended to power off the unit and disconnect it from the power source before replacing the battery. Battery terminals are color coded in red and black. Ensure the corresponding colored wires are connected to the matching color terminals on the battery. The battery is installed with terminals oriented toward the condenser compartment or hinge side of the freezer's outer door (refer **Battery Specification**). With proper installation, the red wire should be connected to the rear battery (positive) terminal and the black wire to the front (common) terminal.

Failure to properly connect the battery can damage electrical components and potentially hinder normal operation of the freezer. Consult a certified service technician if there are any questions or concerns about battery maintenance.

### Battery Specification:

Rechargeable sealed lead-acid battery, 12 V, 7.0 Amp Hr.

Replacement batteries can be purchased directly from Thermo Fisher Scientific.

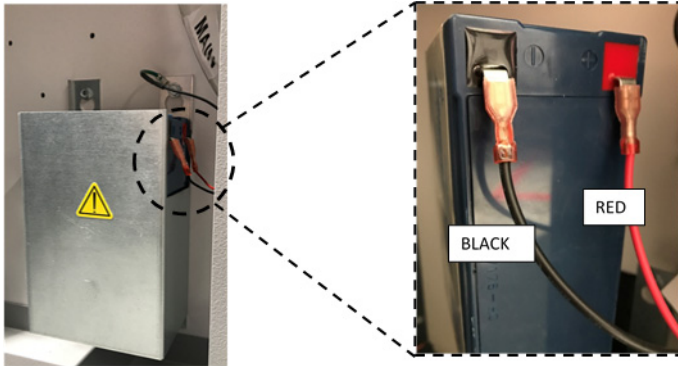

Figure 7. Battery Specification

## Maintenance Schedule

Regular maintenance is important to keep the unit working properly. Inspect/clean as directed in the manual.

Item	Interval
Ice/Frost build up	To maintain proper closure of inner doors, remove any ice or frost build up around the gasket, inner doors, and breakers as necessary.
Gasket	Periodically check the gaskets around the door for punctures or tears. Periodically clean the ice-build up around the gasket.
Filter	Clean the condenser filter(s) every two to three months.
Condenser	Clean every six months, more often if the laboratory area is dusty.
Battery	Replace the battery as indicated by system alarms or as necessary per individual status evaluation. Check the battery connections regularly. Although not required, annual battery replacement is recommended to ensure proper battery status in the event of power failure.
Defrost	Defrost the freezer once a year or when the ice build exceeds 3/8" (0.95 cm).

# Troubleshooting Guide

This section is a guide to troubleshoot general operational problems.

Problem	Cause	Solution
Unit warming Not reaching set point Unit recovers slowly to set point	Warm load/Over load	Allow ample time to recover from loading warm product. Do not overload cabinet. Refer <b>Initial Loading</b> in user manual for loading procedures.
	Hot environment	Check, if the location meets ambient requirements (within 15°C to 32°C or 59°F to 90°F) and away from hot objects.
	Dirty condenser and condenser filter	Clean condenser and filter. Refer <b>Cleaning the Condenser</b> and <b>Cleaning the Condenser Filter</b> in user manual.
	Not enough space for air circulation	Install the unit in a level area free from vibration with a minimum of 8" (20 cm) of space on the top and sides, 6" (15 cm) in back.
	Icing/Frost due to high relative humidity	Check if the location meets requirements. Maximum relative humidity 60% for temperatures within 15°C to 32°C (59°F to 90°F).
	Excess frost build-up in chamber	Defrost the unit. Refer <b>Defrosting the Freezer</b> in user manual.
	Frost build-up on outer door gasket	Wipe with a soft cloth or cryo-gloved hand. Do not use a sharp tool. Be careful not to puncture the rubber gasket.
	Gasket damage	Check for punctures or tears on gasket. Replace if necessary. Refer <b>Gasket Maintenance</b> in user manual.
	Prolonged door openings	Avoid opening of door for a prolonged time. Allow ample time for recovery after door opening.
User interface (Display) failure	Inadequate power supply	Check for proper voltage to the unit.
	Either of the compressors are not working	Call service
	Breaker switch off	Check circuit breaker and reset to on position. Always use a dedicated, properly grounded circuit.
Power failure to the unit		Confirm that the cord is securely plugged in.
	Power supply stopped / Breaker switch off	Plug another appliance into the outlet to see if power is present.  Always use a dedicated, properly grounded circuit.

Problem	Cause	Solution
Unit tripping the circuit breaker	Shared power source	Never connect unit to overloaded power source. Always use a dedicated (separate) circuit.
	Unit plugged into wrong power outlet	Plug the unit into proper power source to deliver correct voltage.
	Unit not grounded	Your unit must be properly grounded in conformity with national and local electrical codes. Troubleshooting procedures involving live voltage is dangerous and if done improperly can result in injury and/or death. This troubleshooting should be performed by trained personnel only.
	Use of extended cords	Do not use an extension cord. Make sure the unit supplied power cord is plugged directly into power outlet.
Excessive frost build-up around perimeter of door	Icing/Frost due to high relative humidity	Check if the location meets requirements. Maximum relative humidity 60% for temperatures within 15°C to 32°C (59°F to 90°F). Occasionally scrape the ice on the outer door. Be careful not to puncture the rubber gasket.
	Excessive and prolonged door openings	Avoid opening door for a prolonged time.
	Gasket damage	Check for punctures or tears on gasket. If replacement is necessary, call service. Refer <b>Gasket Maintenance</b> in user manual.
Unit is over cooling	Set points may have changed	Adjust the setpoint to run at desired setpoint under settings.
	Temperature offset may have changed	Try adjusting the offset. Temperature offset can be set by accessing the settings menu via the settings button.
	Unknown	Try re-starting the unit. If this doesn't help call service.
Unit compressors run continuously	Freezer set point is low	Check whether the setpoint is in operating range. Change the setpoint if necessary.
	Frost build up	Defrost the unit. Refer <b>Defrosting the Freezer</b> in user manual.
	Dirty condenser	Clean the condenser and condenser filter.
	Gasket damage	Check for punctures or tears on gasket. If replacement is necessary, call service. Refer <b>Gasket Maintenance</b> in user manual.
Cabinet temperature reached an alarm condition, but suitable alarm is not activated.	Alarm setpoints may be changed	Check the present setpoints for temperature alarm conditions. Change the setpoints if required.



Problem	Cause	Solution
Problem with temperature validation/calibration	Cabinet temperature displayed doesn't match with actual temperature.	Customers performing on-site temperature calibration may observe as much as a 2°C variation when an external probe is placed next to the freezer control probe. This variation is normal due to optimisation of the control system to ensure temperature uniformity throughout the cabinet.
Unit is constantly alarming	Exterior door is closed but not sealed completely.	Clean any ice build-up on gasket and/or cabinet surface. Check for punctures or tears on gasket.
	Door open alarm, exterior door not closing completely.	Open door completely and immediately close and latch it.
	Door open alarm, exterior door is closed but not sealed completely.	Defrost exterior door gasket and make sure the door is completely sealed.
	Alarm set points may have changed	Change the set points as required.
Unit cycle on-percentage is increasing (Compressors are running more often than before)	Ambient conditions	Unit performance is directly impacted by these causes mentioned. Try maintaining ambient conditions, reducing load, reducing door openings.
	Warm load (or) over load	
	Frequent and prolonged door openings	Once temperature is stable, cycle dynamics should return to normal range. If not call service.
Difficult to close/open the outer door Outer door alignment issues	Unit is not level	Make sure the unit is level. Refer <b>Leveling</b> in the user manual for levelling procedure.
	Frost accumulated on outer door gasket.	Wipe with a soft cloth or cryo-gloved hand. Do not puncture gasket.
	Door latch problem	Ensure door latch is securing. If issue persists, call service.
Difficult to close/open the inner door	Frost accumulated around inner door	Remove frost or ice build-up from inner door assembly.
	Inner door latches damaged	Call service
Vibration noise Rattling noise/Loud noise	Unit is not level	Check if the unit is installed in a level area free from vibration. (Refer <b>Leveling</b> in user manual)
	Loose side panels	Check side panel screws, tighten them if necessary.
	Rubber tubing separators and/or compressor dampeners may have loosened.	Call service

# Error Codes

Error Code	Description
E00	Undefined model
E02	Control Probe Failure
E03	Heat Exchanger Probe Failure
E04	Power Failure
E05	Failure to Reach Setpoint
E06	BUS Battery - Low Voltage
E07	System Battery - Low Voltage
E08	Lost Communication Failure (Main to UI)
E09	Lost Communication Failure (BUS)
E10	Stuck Button
E11	Ambient Probe Failure
E12	System Battery Disconnected
E13	BUS Probe Failure
E14	BUS Battery Disconnected
EA1	Wrong Power

# Warranty

Be sure to register your warranty online:

[www.thermofisher.com/labwarranty](http://www.thermofisher.com/labwarranty)

THERMO FISHER SCIENTIFIC USA FREEZER WARRANTY FOR Revco RDE series, Forma FDE series, HERAFreeze HDE series and Thermo Scientific TDE series.

The Warranty Period starts two weeks from the date your equipment is shipped from our facility. This allows for shipping time so the warranty will go into effect at approximately the same time your equipment is delivered. The warranty protection extends to any subsequent owner during the warranty period.

Component parts proven to be non-conforming in materials or workmanship will be repaired or replaced at Thermo Fisher Scientific's expense, labor included, for a period of five years. Installation and calibration is not covered by this warranty agreement. The Technical Services Department must be contacted for warranty determination and direction prior to any work being performed. Expendable items, i.e., glass, filters, pilot lights, light bulbs, batteries and door gaskets are excluded from this warranty.

Replacement or repair of component parts or equipment under this warranty shall not extend the warranty to either the equipment or to the component part beyond the original five year warranty period. The Technical Services Department must give prior approval for the return of any components or equipment.

THIS WARRANTY IS EXCLUSIVE AND IN LIEU OF ALL OTHER WARRANTIES, WHETHER WRITTEN, ORAL, OR IMPLIED. NO WARRANTIES OF MERCHANTABILITY OR FITNESS FOR A PARTICULAR PURPOSE SHALL APPLY. Thermo shall not be liable for any indirect or consequential damages including, without limitation, damages relating to lost profits or loss of products.

Your local Thermo Fisher Scientific Sales Office is ready to help with comprehensive site preparation information before your equipment arrives. Printed instruction manuals carefully detail equipment installation, operation, and preventive maintenance.

If equipment service is required, please call your Technical Services Department at 1-866-984-3766 (USA and Canada). We're ready to answer your questions on equipment warranty, operation, maintenance, service, and special applications. Outside the USA, contact your local Thermo Fisher Scientific office or distributor for warranty information.

# Warranty (International)

THERMO FISHER SCIENTIFIC FREEZER INTERNATIONAL WARRANTY FOR Revco RDE series, Forma FDE series, HERAFreeze HDE series and Thermo Scientific TDE series.

The Warranty Period starts two months from the date your equipment is shipped from our facility. This allows for shipping time so the warranty will go into effect at approximately the same time your equipment is delivered. The warranty protection extends to any subsequent owner during the warranty period. Dealers who stock our equipment are allowed an additional four months for delivery and installation, providing the warranty card is completed and returned to the Technical Services Department.

Component parts proven to be non-conforming in materials or workmanship will be repaired or replaced at Thermo Fisher Scientific's expense, labor excluded, for a period of five years. Installation and calibration is not covered by this warranty agreement. The Technical Services Department must be contacted for warranty determination and direction prior to any work being performed. Expendable items, i.e., glass, filters, pilot lights, light bulbs, batteries and door gaskets are excluded from this warranty.

Replacement or repair of component parts or equipment under this warranty shall not extend the warranty to either the equipment or to the component part beyond the original five year warranty period. The Technical Services Department must give prior approval for the return of any components or equipment.

THIS WARRANTY IS EXCLUSIVE AND IN LIEU OF ALL OTHER WARRANTIES, WHETHER WRITTEN, ORAL, OR IMPLIED. NO WARRANTIES OF MERCHANTABILITY OR FITNESS FOR A PARTICULAR PURPOSE SHALL APPLY. Thermo shall not be liable for any indirect or consequential damages including, without limitation, damages relating to lost profits or loss of products.

Your local Thermo Fisher Scientific Sales Office is ready to help with comprehensive site preparation information before your equipment arrives. Printed instruction manuals carefully detail equipment installation, operation, and preventive maintenance.

If equipment service is required, please contact your local Thermo Fisher Scientific office or local distributor.

We're ready to answer your questions on equipment warranty, operation, maintenance, service, and special applications. Outside the USA, contact your local Thermo Fisher Scientific office or distributor for warranty information.

# Appendix A: Alarm Summary

Alarm Summary			
Alarm Message	Warning Icon	Remote Alarm Event	Description
Warm Alarm	Thermometer	Yes	The freezer temperature has exceeded the warm alarm set point. Prolonged door openings and warm product loading may cause warm alarms.
Cold Alarm	Thermometer	Yes	The freezer temperature has exceeded the cold alarm set point.
Door Open Ajar	Door	Yes	Door open for greater than 3 minutes will cause door open alarm.
Control Probe Failure	Wrench	Yes	Cannot display cabinet temperature. The freezer will continue to operate in full run mode. Contact customer service. Display will intermittently show "E02".
Heat Exchange Probe Failure	Wrench	Yes	The freezer will continue to operate with current freezer setpoints, but cabinet temperature variation will increase. Contact customer service. Display will intermittently show "E03".
Ambient Probe Failure	Wrench	Yes	Ambient Probe TC has malfunctioned. This doesn't affect the performance of the unit. Contact service for further assistance. Display will intermittently show "E11".
Main to UI Lost Communication	Wrench	Yes	A communication error has occurred within the system. Contact customer service. Display will intermittently show "E08".
BUS Lost Communication	Wrench	Yes	A communication error has occurred within the backup system. Contact customer service. Display will intermittently show "E09".
Failure to Reach Set point	Wrench	Yes	Door openings or product loading may cause this notification. Allow unit to stabilize. If condition persists, contact customer service. Display will intermittently show "E05".
Power Failure Alarm	Wrench	Yes	Unit in power failure mode. Display operating on battery power. Check unit plug, unit circuit breaker in the ON position, and supply voltage. Display will intermittently show "E04".

## Alarm Summary

Alarm Message	Warning Icon	Remote Alarm Event	Description
Wrong Model Alarm	Wrench	Yes	Invalid Control Model Alarm. Contact service to ensure the correct model is selected for the system to avoid cargo loss. Display will intermittently show “E00”.
System Battery Low Voltage Alarm	Wrench	Yes	System Battery voltage is too low. If error persists, the battery may need to be replaced. Display will intermittently show “E07”.
BUS Battery Low Voltage Alarm	Wrench	Yes	BUS Battery voltage is too low. If error persists, the battery may need to be replaced. Display will intermittently show “E06”.
Stuck Button Alarm	Wrench	Yes	A button has been pressed for more than 5 minutes. Display will intermittently show “E10”.
System Battery Failure Alarm	Wrench	Yes	System battery disconnected or failed. Display will intermittently show “E12”.
BUS Probe Failure Alarm	Wrench	Yes	BUS cannot detect temperature. BUS will continuously inject. Contact customer service. Display will intermittently show “E13”.
BUS Battery Failure Alarm	Wrench	Yes	BUS battery disconnected or failed. Display will intermittently show “E14”.
Wrong Power Alarm	Wrench	Yes	The unit has detected Wrong Power connected. Verify the proper voltage. Display will intermittently show “EA1”.

# Appendix B: Modbus ASCII Parameter Table

Protocol	MODBUS ASCII
Baud Rate	2400bps to 57.6Kbps
Data Bits	7
Stop Bits	1
Parity	Even
Flow Control	None
Address	0 to 255

**Table 4.**

S. No	Parameter	Function Code	Address in hexa decimal	Size	Modbus Command	Relay Enclosure Response	Data	Data Type	Remarks
01	Cabinet Setpoint (C)	0x03	530	2	3A 30 31 30 33 <b>30</b> <b>35 33 30</b> 30 30 30 32 43 35 0D 0A	3A 30 31 30 33 30 34 <b>46</b> <b>46 46 46 46</b> <b>43 45 30 31</b> 45 0D 0A	0xFF FFF CE0	int	Convert the data value into signed 2's complement and divide with 10, which gives the setpoint.  Ex: Signed 2's complement of the 0xFFFFFCE0 is equal to -800.  -800/10= -80. So the setpoint is -80C.
02	Warm Alarm Setpoint (C)	0x03	538	2	3A 30 31 30 33 <b>30</b> <b>35 33 38</b> 30 30 30 32 42 44 0D 0A	3A 30 31 30 33 30 34 <b>46</b> <b>46 46 46 46</b> <b>44 34 34 42</b> 39 0D 0A	0xFF FFF D44	int	Convert the data value into signed 2's complement and divide with 10, which gives the setpoint.  Ex: Signed 2's complement of the 0xFFFFFD44 is equal to -700.  -700/10= -70. So the WA setpoint is -70 C.

S. No	Parameter	Function Code	Address in hexadecimal	Size	Modbus Command	Relay Enclosure Response	Data	Data Type	Remarks
03	Cold Alarm Setpoint (C)	0x03	053C	2	3A 30 31 30 33 <b>30</b> <b>35 33 43</b> 30 30 30 32 42 39 0D 0A	3A 30 31 30 33 30 34 <b>46</b> <b>46 46 46 46</b> <b>43 37 43 38</b> 32 0D 0A	0xFF FFF C7C	int	Convert the data value into signed 2's complement and divide with 10, which gives the setpoint. Ex: Signed 2's complement of the 0xFFFFFC7C is equal to -900. -900/10=-90. So the CA setpoint is -90C.
04	System Bill of Material Part Number	0x03	570	2	3A 30 31 30 33 <b>30</b> <b>35 37 30</b> 30 30 30 32 38 35 0D 0A	3A 30 31 30 33 30 34 <b>33</b> <b>31 33 35 33</b> <b>35 34 34 31</b> 39 0D 0A	0x31 0x35 0x35 0x44	string	
05	System Bill of Material Part Number	0x03	574	2	3A 30 31 30 33 <b>30</b> <b>35 37 34</b> 30 30 30 32 38 31 0D 0A	3A 30 31 30 33 30 34 <b>35</b> <b>32 33 30 34</b> <b>31 33 30 30</b> 35 0D 0A	0x52 0x30 0x41 0x30	string	To get BOM combine 570,574,578 data. Ex. 155DR0A01R
06	System Bill of Material Part Number	0x03	578	2	3A 30 31 30 33 <b>30</b> <b>35 37 38</b> 30 30 30 32 37 44 0D 0A	30 31 30 33 30 34 <b>33 31</b> <b>35 32 32 30</b> <b>32 30 33 35</b> 0D 0A	0x31 0x52 0x20 0x20	string	
07	System Bill of Material Part Number	0x03	57C	2	3A 30 31 30 33 <b>30</b> <b>35 37 43</b> 30 30 30 32 37 39 0D 0A	3A 30 31 30 33 30 34 <b>32</b> <b>30 32 30 32</b> <b>30 32 30 37</b> 38 0D 0A	0x20 0x20 0x20 0x20 0x20 0x20	string	All the remaining are spaces.
08	System Bill of Material Part Number	0x03	580	2	3A 30 31 30 33 <b>30</b> <b>35 38 30</b> 30 30 30 32 37 35 0D 0A	3A 30 31 30 33 30 34 <b>32</b> <b>30 32 30 32</b> <b>30 32 30 37</b> 38 0D 0A	0x20	string	All the remaining are spaces.



Table 4.

S. No	Parameter	Function Code	Address in hexadecimal	Size	Modbus Command	Relay Enclosure Response	Data	Data Type	Remarks
09	Product ID	0x03	598	2	3A 30 31 30 33 <b>30</b> <b>35 39 38</b> 30 30 30 32 35 44 0D 0A	3A 31 39 30 33 30 34 <b>30</b> <b>30 30 31 45</b> <b>32 34 30 42</b> 39 0D 0A	0x00 01E2 40	uint	123456 would be encoded as 0x01E240.
10	Control Model	0x03	59C	1	3A 30 31 30 33 <b>30</b> <b>35 39 43</b> 30 30 30 31 35 41 0D 0A	3A 30 31 30 33 30 32 <b>30</b> <b>30 30 34 46</b> 36 0D 0A	0x00	uchar	<p><b>Note:</b> bits b4:b1</p> <p>0000: PEEK Production Code (CNTRL 0)</p> <p>0002: Variable Speed Compressor (CNTRL 2)</p> <p>0003: Single Speed and Cascade System (CNTRL 3)</p> <p>0004: Single Speed and Single Stage System (CNTRL 4)</p> <p>0005: Single Speed and Cascade System (CNTRL 5)</p>
11	Size	0x03	59D	1	3A 30 31 30 33 <b>30</b> <b>35 39 44</b> 30 30 30 31 35 39 0D 0A	3A 30 31 30 33 30 32 <b>30</b> <b>30 30 33 46</b> 37 0D 0A	0x00	uchar	<p>5 units sizes</p> <p>0 - 300,</p> <p>1- 400,</p> <p>2 - 500,</p> <p>3 - 600,</p> <p>4 - 700</p>

S. No	Parameter	Function Code	Address in hexadecimal	Size	Modbus Command	Relay Enclosure Response	Data	Data Type	Remarks
12	TC1	0x03	04C8	2	3A 30 31 30 33 <b>30</b> <b>34 43 38</b> 30 30 30 32 32 45 0D 0A	3A 30 31 30 33 30 34 <b>34</b> <b>32 31 37 44</b> 30 30 31 43 45 0D 0A	0x42 17D0 01	Float	Convert the Float to decimal with below steps:  1.Open the link <a href="https://www.h-schmidt.net/FloatConverter/IEEE754.html">https://www.h-schmidt.net/FloatConverter/IEEE754.html</a>  2.Paste the data in “Hexadecimal Representation” and press Enter.  3.The temp value is shown in “Decimal representation”
13	TC2	0x03	04CC	2	3A 30 31 30 33 <b>30</b> <b>34 43 43</b> 30 30 30 32 32 41 0D 0A	3A 30 31 30 33 30 34 <b>34</b> <b>31 38 45 34</b> <b>43 30 35 44</b> 38 0D 0A	0x41 8E4 C05	Float	Convert the Float to decimal with below steps:  1.Open the link <a href="https://www.h-schmidt.net/FloatConverter/IEEE754.html">https://www.h-schmidt.net/FloatConverter/IEEE754.html</a>  2.Paste the data in “Hexadecimal Representation” and press Enter.  3.The temp value is shown in “Decimal representation”
14	TC3	0x03	04D0	2	3A 30 31 30 33 <b>30</b> <b>34 44 30</b> 30 30 30 32 32 36 0D 0A	3A 30 31 30 33 30 34 <b>43</b> <b>32 38 44 46</b> <b>42 45 34 43</b> 41 0D 0A	0xC2 8DF BE4	Float	Convert the Float to decimal with below steps:  1.Open the link <a href="https://www.h-schmidt.net/FloatConverter/IEEE754.html">https://www.h-schmidt.net/FloatConverter/IEEE754.html</a>  2.Paste the data in “Hexadecimal Representation” and press Enter.  3.The temp value is shown in “Decimal representation”

S. No	Parameter	Function Code	Address in hexadecimal	Size	Modbus Command	Relay Enclosure Response	Data	Data Type	Remarks
15	TC4	0x03	04D4	2	3A 30 31 30 33 <b>30</b> <b>34 44 34</b> 30 30 30 32 32 32 0D 0A	3A 30 31 30 33 30 34 <b>43</b> <b>32 38 44 46</b> <b>33 32 38 38</b> 45 0D 0A	0xC2 8DF 328	Float	Convert the Float to decimal with below steps:  1.Open the link <a href="https://www.h-schmidt.net/FloatConverter/IEEE754.html">https://www.h-schmidt.net/FloatConverter/IEEE754.html</a>  2.Paste the data in “Hexadecimal Representation” and press Enter.  3.The temp value is shown in “Decimal representation”
16	TC5	0x03	04D8	2	3A 30 31 30 33 <b>30</b> <b>34 44 38</b> 30 30 30 32 31 45 0D 0A	3A 30 31 30 33 30 34 <b>34</b> <b>32 31 37 44</b> <b>30 30 31 43</b> 45 0D 0A	0x42 17D0 01	Float	Convert the Float to decimal with below steps:  1.Open the link <a href="https://www.h-schmidt.net/FloatConverter/IEEE754.html">https://www.h-schmidt.net/FloatConverter/IEEE754.html</a>  2.Paste the data in “Hexadecimal Representation” and press Enter.  3.The temp value is shown in “Decimal representation”
17	TC6	0x03	04DC	2	3A 30 31 30 33 <b>30</b> <b>34 44 43</b> 30 30 30 32 31 41 0D 0A	3A 30 31 30 33 30 34 <b>34</b> <b>32 31 37 44</b> <b>30 30 31 43</b> 45 0D 0A	0x42 17D0 01	Float	Convert the Float to decimal with below steps:  1.Open the link <a href="https://www.h-schmidt.net/FloatConverter/IEEE754.html">https://www.h-schmidt.net/FloatConverter/IEEE754.html</a>  2.Paste the data in “Hexadecimal Representation” and press Enter.  3.The temp value is shown in “Decimal representation”

Table 4.

S. No	Parameter	Function Code	Address in hexadecimal	Size	Modbus Command	Relay Enclosure Response	Data	Data Type	Remarks
18	TC7	0x03	04E0	2	3A 30 31 30 33 <b>30</b> <b>34 45 30</b> 30 30 30 32 31 36 0D 0A	3A 30 31 30 33 30 34 <b>34</b> <b>32 31 37 44</b> <b>30 30 31</b> 43 45 0D 0A	0x42 17D0 01	Float	Convert the Float to decimal with below steps:  1.Open the link <a href="https://www.h-schmidt.net/FloatConverter/IEEE754.html">https://www.h-schmidt.net/FloatConverter/IEEE754.html</a>  2.Paste the data in “Hexadecimal Representation” and press Enter.  3.The temp value is shown in “Decimal representation”
19	TC8	0x03	04E4	2	3A 30 31 30 33 <b>30</b> <b>34 45 34</b> 30 30 30 32 31 32 0D 0A	3A 30 31 30 33 30 34 <b>34</b> <b>32 31 37 44</b> <b>30 30 31</b> 43 45 0D 0A	0x42 17D0 01	Float	Convert the Float to decimal with below steps:  1.Open the link <a href="https://www.h-schmidt.net/FloatConverter/IEEE754.html">https://www.h-schmidt.net/FloatConverter/IEEE754.html</a>  2.Paste the data in “Hexadecimal Representation” and press Enter.  3.The temp value is shown in “Decimal representation”
20	TC9	0x03	04E8	2	3A 30 31 30 33 <b>30</b> <b>34 45 38</b> 30 30 30 32 30 45 0D 0A	3A 30 31 30 33 30 34 <b>43</b> <b>32 41 32 42</b> <b>46 42 38</b> 31 44 0D 0A	0xC2 A2B FB8	Float	Convert the Float to decimal with below steps.  1.Open the link <a href="https://www.h-schmidt.net/FloatConverter/IEEE754.html">https://www.h-schmidt.net/FloatConverter/IEEE754.html</a>  2.Paste the data in “Hexadecimal Representation” and press Enter.  3.The temp value is shown in “Decimal representation”

S. No	Parameter	Function Code	Address in hexadecimal	Size	Modbus Command	Relay Enclosure Response	Data	Data Type	Remarks
21	TC10	0x03	04EC	2	3A 30 31 30 33 <b>30</b> <b>34 45 43</b> 30 30 30 32 30 41 0D 0A	3A 30 31 30 33 30 34 <b>43</b> <b>31 30 42 46</b> <b>30 30 43 33</b> 30 0D 0A	0xC1 0BF0 0C	Float	<p>Convert the Float to decimal with below steps.</p> <p>1.Open the link <a href="https://www.h-schmidt.net/FloatConverter/IEEE754.html">https://www.h-schmidt.net/FloatConverter/IEEE754.html</a></p> <p>2.Paste the data in “Hexadecimal Representation” and press Enter.</p> <p>3.The temp value is shown in “Decimal representation”.</p>
22	Display Managed RTD Temperature	0x03	500	2	3A 30 31 30 33 <b>30</b> <b>35 30 30</b> 30 30 30 32 46 35 0D 0A	3A 31 39 30 33 30 34 <b>46</b> <b>46 46 46 46</b> <b>46 42 33 32</b> 43 0D 0A	0xFF FFF B2	int	<p>Convert the data value into signed 2's complement which gives the data.</p> <p>Ex: Signed 2's complement of the 0xFFFFFB2 is equal to -78.</p> <p>So the Display Managed RTD Temperature value is -78°C.</p>

S. No	Parameter	Function Code	Address in hexadecimal	Size	Modbus Command	Relay Enclosure Response	Data	Data Type	Remarks
23	Alarms	0x03	514	2	3A 30 31 30 33 <b>30</b> <b>35 31 34</b> 30 30 30 32 45 31 0D 0A	3A 30 31 30 33 30 34 <b>30</b> <b>30 30 34 38</b> <b>30 31 30 36</b> 34 0D 0A	0x00 0480 10	uint	1 = Active / 0 = Inactive b19 BUS Battery Disconnection, b18 System Battery Disconnection, b17 Water temperature, b16 Wrong Power, b15 Refrigeration System Failure (TSX only), b14 Reserved for factory use only (Water Cooled pressure alarm if applicable), b13 Unused, b12 Clean filter Alarm, b11 Reserved for factory use only, b10 Buck boost ineffective, b9 BUS battery low, b8 Setpoint attain timed out (every cycle), b7 Health of compressor (sump temp), b6 - Extreme Ambient, b5 - System Battery Low, b4 - Control Probe Fail, b3 - Door Open, b2 - Cold Alarm, b0 - Power Failure Alarm

S. No	Parameter	Function Code	Address in hexa decimal	Size	Modbus Command	Relay Enclosure Response	Data	Data Type	Remarks
24	System Status	0x03	671	1	3A 30 31 30 33 <b>30</b> <b>36 37 31</b> 30 30 30 31 38 34 0D 0A	3A 31 39 30 33 30 32 <b>32</b> <b>38</b> 42 41 0D 0A	0x28	uchar	b0 - Temperature pull down attained, b1 - Power failure, b2 - Main - UI comm failure, b3 - Service Mode Active, b4 - main shutdown, b5 - BOT status (set only after entry to BOT), b6 - unused, b7 - Bus comm failure

S. No	Parameter	Function Code	Address in hexa decimal	Size	Modbus Command	Relay Enclosure Response	Data	Data Type	Remarks
25	Relay Enclosure Status	0x03	674	2	3A 30 31 30 33 <b>30</b> <b>36 37 34</b> 30 30 30 32 38 30 0D 0A	3A 31 39 30 33 30 34 <b>30</b> <b>30 30 35 30</b> <b>30 30 30 44</b> 37 0D 0A	0x00 0500 00	uint	b0 - Bus Solenoid Injection b1 - Bus Pressure switch b2 - Reserved for factory use only b3 - Line voltage circuit state change (normal, buck, boost) b4 - Compensated line voltage change b5 - Reserved for factory use only b6 - Short cycle active b7 - 4-20mA digital to analog converter data corrupt b8 - Next Power up state b9 - Door1 Open b10 - Door2 Open b11 - Warm temperature alarm test Active b12 - Read Reset status register b13 - Water cool system pressure sensor state (water cooled units only) b14 - 4-20mA digital to analog converter over temp fault b15 - 4-20mA digital to analog converter over current of the integrated chip fault b16 - Main memory corrupt b17 - Back up memory corrupt



S. No	Parameter	Function Code	Address in hexadecimal	Size	Modbus Command	Relay Enclosure Response	Data	Data Type	Remarks
26	Build Number	0x03	524	2	3A 30 31 30 33 <b>30</b> <b>35 32 34</b> 30 30 30 32 44 31 0D 0A	3A 31 39 30 33 30 34 <b>30</b> <b>30 30 30 30</b> <b>44 30 31 43</b> 45 0D 0A	0x00 000D 01	uint	XX/XX Minor (numbers after decimal point)/ Major (numbers before decimal point) Ex: 1301 translates to Build number is 1.13
27	Cabinet Calibration Offset	0x03	534	2	3A 30 31 30 33 <b>30</b> <b>35 33 34</b> 30 30 30 32 43 31 0D 0A	3A 30 31 30 33 30 34 <b>30</b> <b>30 30 30 30</b> <b>30 30 30 46</b> 38 0D 0A	0x00 0000 00	int	Convert the data value into signed 2's complement and divide with 10, which gives the setpoint. Ex: Signed 2's complement of the 0x00000000 is equal to 0. 0/10=0. So the setpoint is 0C.
28	Line Voltage	0x03	04F8	2	3A 30 31 30 33 <b>30</b> <b>34 46 38</b> 30 30 30 32 46 45 0D 0A	3A 31 39 30 33 30 34 <b>30</b> <b>30 30 30 30</b> <b>30 45 34 46</b> 34 0D 0A	0x00 0000 E4	uint	Convert the data value into signed 2's complement and divide with 10, which gives the setpoint. Ex: Signed 2's complement of the 0x00000000 is equal to 0. 0/10=0. So the setpoint is 0C.
29	Bus RTD (Applicable only for backup system available)	0x03	680	2	3A 30 31 30 33 <b>30</b> <b>36 38 30</b> 30 30 30 32 37 34 0D 0A	3A 30 31 30 33 30 34 <b>30</b> <b>30 30 30 30</b> <b>30 30 30 46</b> 38 0D 0A	0x00 0000 00	Float	Convert the Float to decimal with below steps: 1.Open the link <a href="https://www.h-schmidt.net/FloatConverter/IEEE754.html">https://www.h-schmidt.net/FloatConverter/IEEE754.html</a> 2.Paste the data in "Hexadecimal Representation" and press Enter. 3.The temp value is shown in "Decimal representation"

# WEEE Compliance

**WEEE Compliance.** This product is required to comply with the European Union's Waste Electrical & Electronic Equipment (WEEE) Directive 2012/19/EU. It is marked with the following symbol. Thermo Fisher Scientific has contracted with one or more recycling/disposal companies in each EU Member State, and this product should be disposed of or recycled through them. Further information on our compliance with these Directives, the recyclers in your country, and information on Thermo Scientific products which may assist the detection of substances subject to the RoHS Directive are available at [www.thermofisher.com/WEEERoHS](http://www.thermofisher.com/WEEERoHS).

**Great Britain**



**WEEE Konformität.** Dieses Produkt muss die EU Waste Electrical & Electronic Equipment (WEEE) Richtlinie 2012/19/EU erfüllen. Das Produkt ist durch folgendes Symbol gekennzeichnet. Thermo Fisher Scientific hat Vereinbarungen getroffen mit Verwertungs-/Entsorgungsanlagen in allen EU-Mitgliederstaaten und dieses Produkt muss durch diese Firmen verwertet oder entsorgt werden. Mehr Informationen über die Einhaltung dieser Anweisungen durch Thermo Scientific, die Verwerter und Hinweise die Ihnen nützlich sein können, die Thermo Fisher Scientific Produkte zu identifizieren, die unter diese RoHS-Anweisung fallen, finden Sie unter [www.thermofisher.com/WEEERoHS](http://www.thermofisher.com/WEEERoHS).

**Deutschland**



**Conformità WEEE.** Questo prodotto deve rispondere alla direttiva dell'Unione Europea 2012/19/EU in merito ai Rifiuti degli Apparecchi Elettrici ed Elettronici (WEEE). È marcato col seguente simbolo. Thermo Fisher Scientific ha stipulato contratti con una o diverse società di riciclaggio/smaltimento in ognuno degli Stati Membri Europei. Questo prodotto verrà smaltito o riciclato tramite queste medesime. Ulteriori informazioni sulla conformità di Thermo Fisher Scientific con queste Direttive, l'elenco delle ditte di riciclaggio nel Vostro paese e informazioni sui prodotti Thermo Scientific che possono essere utili alla rilevazione di sostanze soggette alla Direttiva RoHS sono disponibili sul sito [www.thermofisher.com/WEEERoHS](http://www.thermofisher.com/WEEERoHS).

**Italia**

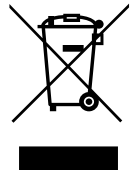

**Conformité WEEE.** Ce produit doit être conforme à la directive euro-péenne (2012/19/EU) des Déchets d'Equipements Electriques et Electroniques (DEEE). Il est marqué par le symbole suivant. Thermo Fisher Scientific s'est associé avec une ou plusieurs compagnies de recyclage dans chaque état membre de l'union européenne et ce produit devrait être collecté ou recyclé par celles-ci. Davantage d'informations sur la conformité de Thermo Fisher Scientific à ces directives, les recycleurs dans votre pays et les informations sur les produits Thermo Fisher Scientific qui peuvent aider la détection des substances sujettes à la directive RoHS sont disponibles sur [www.thermofisher.com/WEEERoHS](http://www.thermofisher.com/WEEERoHS).

**France**

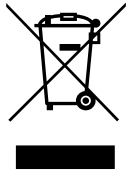

This page is  
intentionally  
left blank.

## Contact Information

Thermo Fisher Scientific products are backed by a global technical support team ready to support your applications. We offer cold storage accessories, including remote alarms, temperature recorders, and validation services.

Visit [www.thermofisher.com/cold](http://www.thermofisher.com/cold) or call:

Countries	Sales
North America	+1 866 984 3766
India toll free	1800 22 8374
India	+91 22 6716 2200
China	+800 810 5118, +400 650 5118
Japan	+81 3 5826 1616
France	+33 2 2803 2180
Germany international	+49 6184 90 6000
Germany national toll free	0800 1 536 376
UK/Ireland	+44 870 609 9203

For countries not listed here, visit [www.thermofisher.com](http://www.thermofisher.com) and go to the Contact Us page under the Services menu to locate the contact information for your area.

Thermo Fisher Scientific Inc.  
275 Aiken Road  
Asheville, NC 28804  
United States

Thermo Fisher Scientific (Suzhou) Instruments Co., Ltd  
297, Taishan Road  
Suzhou, 215219  
P.R.China

Find out more at [thermofisher.com/cold](http://thermofisher.com/cold)

**ThermoFisher**  
S C I E N T I F I C