

Logic[®] Vue

Class II Enclosures

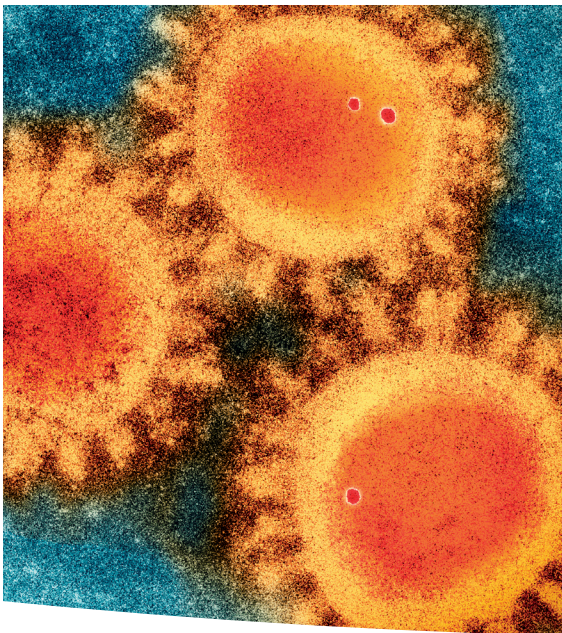



Table of Contents

Why Labconco?	3	Features and Benefits	8
Enclosures At-a-Glance		Ordering Information and Accessories	9
Steps to Selecting a Biosafety Enclosure	4	Dimensions	10
Biosafety Enclosure Product Lines	5	Specifications	11
Logic® Vue Class II Enclosure	6		
Features	7		

Go Big on Biosafety.

Safety. Class II containment that meets NSF Standard 49 for personnel and product protection, plus robust construction ensure the Logic Vue keeps you safe while automating research.

Convenience. At 65% larger than a standard BSC, the Logic Vue is compatible with a variety of automated instruments. Accessibility and visibility from multiple sides allows for effortless operation and observation.

Intelligence. MyLogic™ OS is simple to operate and includes smart systems like, CAP™ technology, which continually monitors and auto-adjusts system airflows for maximum safety. Intuitive connectivity talks directly to automated instruments, pausing work when conditions are unsafe.

Don't trade safety for convenience. Choose both.



Labconco Biosafety Cabinets & Enclosures

Steps to Selecting a Biosafety Enclosure

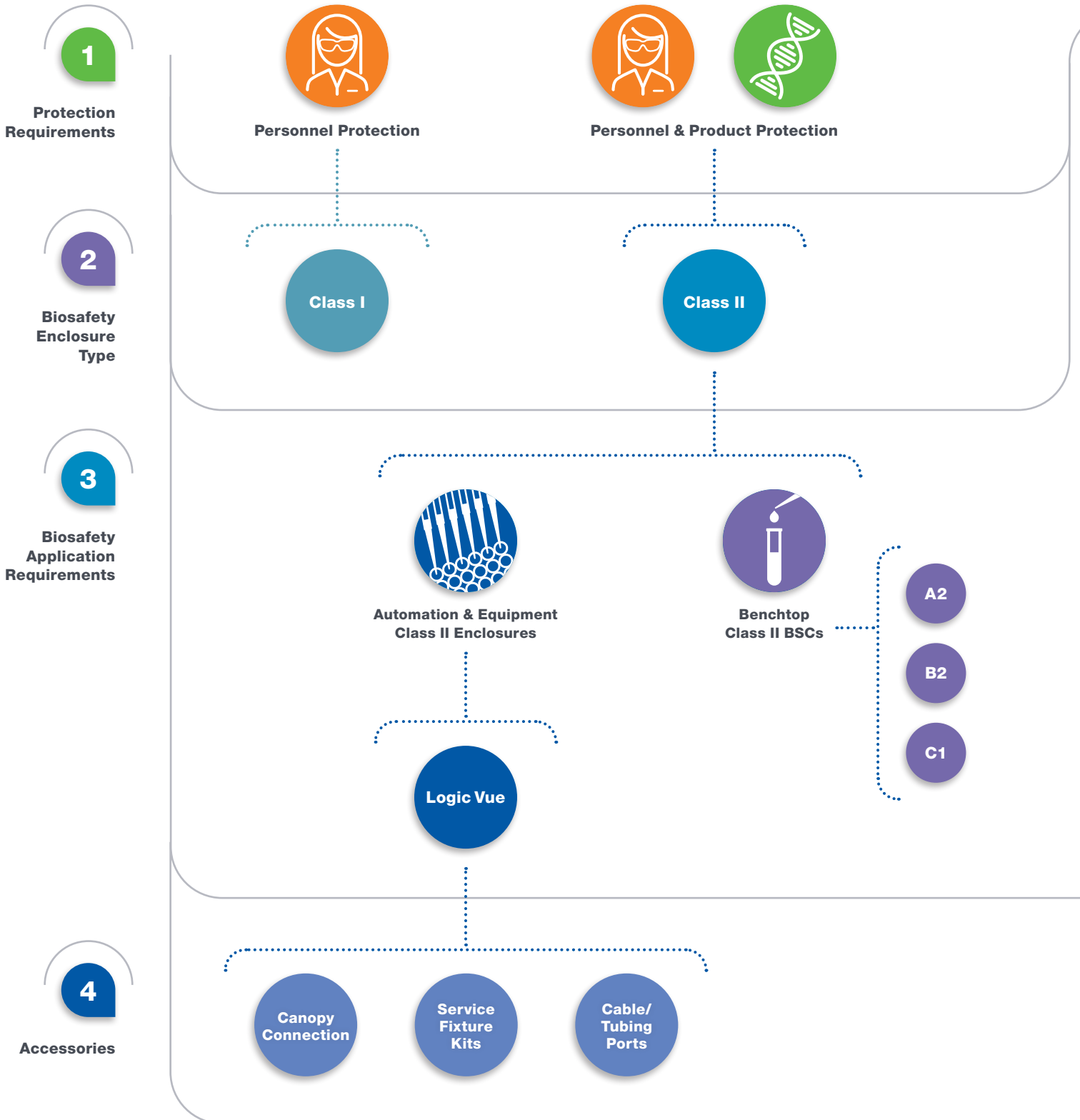

Labconco Biosafety Cabinets & Enclosures

Logic® and Axiom® Class II Products

Large Class II Biosafety Enclosures



Logic Vue



Class II Biosafety Cabinets



Logic+ Type A2



Logic+ Type B2



Logic Vue Accessories



Service Fixture Kits

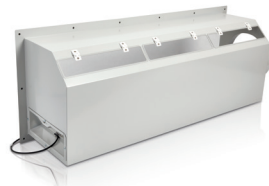

Canopy Connection



Cable/Tubing Ports



Axiom Type C1



Labconco Class II Enclosures

Features

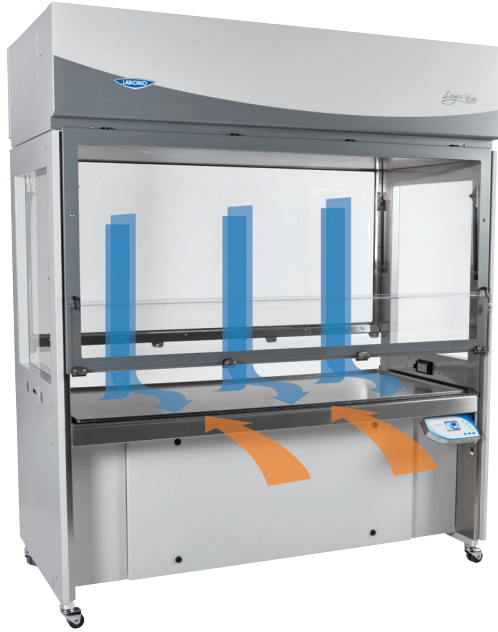

The Logic Vue Class II Enclosure

provides personnel and product protection:

- Meets NSF/ANSI Standard 49 for personnel and product protection
- Laminar ISO 5 or better air (99.99% efficient at 0.3 microns)
- Constant Airflow Profile™ auto-adjusting blowers contain biohazards while maintaining aseptic conditions within the enclosure



Convenience for Instrumentation

- Excellent visibility from all sides of enclosure
- Large 42.2" (107.1 cm) interior height provides ample space for tall instruments
- Deep 34.7" (88.1 cm) interior
- Spacious 31" (78.8 cm) interior working depth provides clearance for a variety of instruments
- Dual full-open sashes provide easy access for equipment loading and servicing

Labconco Class II Enclosures

Features

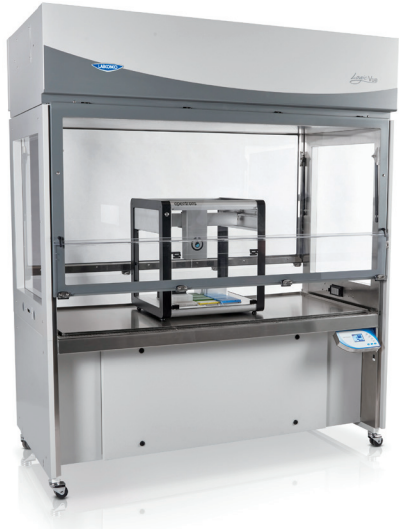

Convenient design provides unrestricted front-side access to entire work area during operation. An ergonomic knee well provides comfort while seated.



MyLogic™ OS intuitively communicates important status updates, such as alerts and filter life remaining. An intelligent safety interlock pauses automated instruments when operating conditions are unsafe.

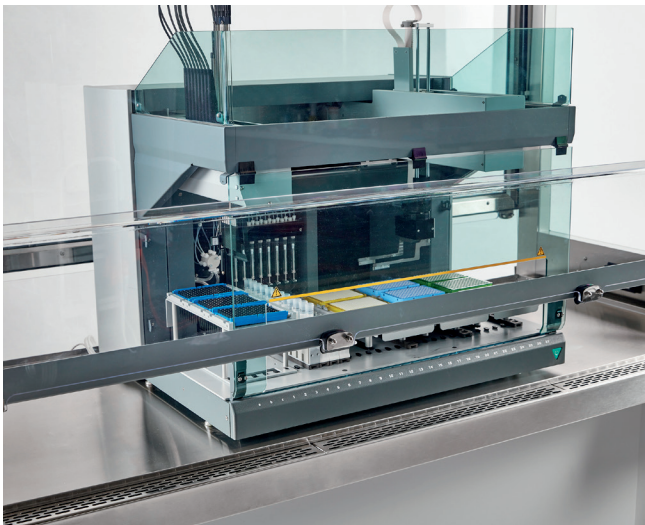

Robust work surface with included SpillStopper tray supports equipment up to 250.0 lbs (113.4 kg) per every two feet (60.1 cm).



Multiple pass-throughs allow safe passage of cables, cords, aerosol management systems, chillers and more.

Logic® Vue Class II Enclosures

Features & Benefits



Designed for instrumentation
including liquid handlers, cell sorters, and more.

Meets NSF/ANSI 49
requirements for personnel and product protection.

Ergonomic design
Comfortably sit or stand with built-in knee space and adjustable working height.

HEPA supply and exhaust
filters are minimum 99.99% efficient (at 0.3 microns), providing ISO 5 or better air.

CAP™ Technology
continuously monitors and adjusts airflow to keep users safe.

Dual full-open sashes
provide easy access for equipment loading and servicing.

Front sash opening
provides unobstructed access to entire work surface during operation.

Stainless steel interior
Type 304 construction with reinforced work surface for easy decontamination.

Versatile design
Maximum visibility, pass-throughs, access doors, and Ergotron® compatible.

Ships fully assembled
No complicated or expensive installation required. Fits through standard door frames.

MyLogic™ OS Information Center



LCD Display
Clearly visualizes cabinet conditions in eight languages.

Filter Life Indicator
Accurately displays remaining HEPA filter life. Alerts users at 20% and 10% before alarming at 0%.

Blower Status
Displays when blowers are turned on, in reduced flow mode, or off.

Alerts & Alarms
Visual and audible signals notify users of unsafe cabinet conditions.

Safety Interlock
Optional connection pauses/stops automation equipment when sash is opened.

Data Connectivity
Exports system information via USB or dry contact relays for remote monitoring.

Ergotron® is a registered trademark of Ergotron Inc.

Logic® Vue Class II Enclosures

Ordering Information & Accessories

Catalog Number Configurator Use this key to configure the seven digit catalog number.

3	3	0	0	□	0	□
Select the WIDTH of your enclosure. This is the fifth digit of your catalog number.				Select the ELECTRICAL CONFIGURATION of your enclosure. This is the seventh digit of your catalog number.		
6 = 6'				0 = 115V, 50/60 Hz, 30A		
				1 = 230V, 50/60 Hz, 20A		

All models require (not included):

- Dedicated electrical circuit

Shipping Data

Model	Shipping Width	Shipping Depth	Shipping Height	Shipping Weight
6'	91.5" (232.4 cm)	51.0" (129.5 cm)	105.0" (266.7 cm)	1275 lbs (578 kg)

ACCESSORIES

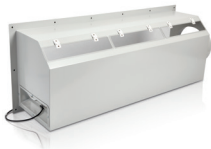

Logic Vue Canopy Connection. For thimble exhausting Logic Vue Class II Enclosures. Canopy maintains a negative pressure connection to house exhaust. Detects insufficient exhaust in less than one second and signals Logic

Vue LCD to show an alarm. Adds 9.8" (24.8 cm) to overall depth. Powder-coated steel. Collar is 10" (25.4 cm) ID. Exhaust connection is required. **Damper (82001-060) is recommended and remote exhaust is required (not included).** Shipping weight 80 lbs. (36 kg)

76449-826—6' Logic Vue Canopy Connection. Requires up to 1352 CFM* @ 0.15" H₂O exhaust conditions.

76449-832—Safety Interlock Cable. Provides interface between the Logic Vue and automation devices that employ a safety interlock. Opening the sash of the Logic Vue triggers the interlock, immediately signaling a device to pause or stop. Shipping weight 3.0 lbs. (1.4 kg)

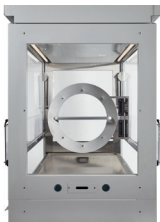

Large Access Port(s). Provide extra access through sashes or side windows. Up to two per Logic Vue. Factory-install only. Contact your VWR/Avantor representative for information.

76449-834—Airflow Sensor Kit. Displays inflow and downflow velocities on MyLogic OS screen. Includes sensor, wiring harness and hardware. **Installation and certifier calibration required.** Shipping weight 3.0 lbs. (1.4 kg)



Large Tubing Pass-Throughs. For passage of larger tubing through sidewall of Logic Vue for external equipment such as aerosol management systems, chillers or other supportive equipment. Inner tube and outer flange constructed of 16 gauge 304 stainless steel. Adds

1.8" (4.6 cm) to overall width. **Installation is required.** Shipping weight 3.0 lbs. (1.4 kg)

76449-828—Large Tubing Pass-Through. 0.75" OD (1.91 cm).

76449-830—Large Tubing Pass-Through. 1.25" OD (3.18 cm).

Contact for ordering information—Replacement Prefilter. Extends life of the supply HEPA filter. Shipping weight 3.0 lbs. (1.4 kg)

*Value obtained via pitot tube traverse.

Logic® Vue Class II Enclosures

Dimensions

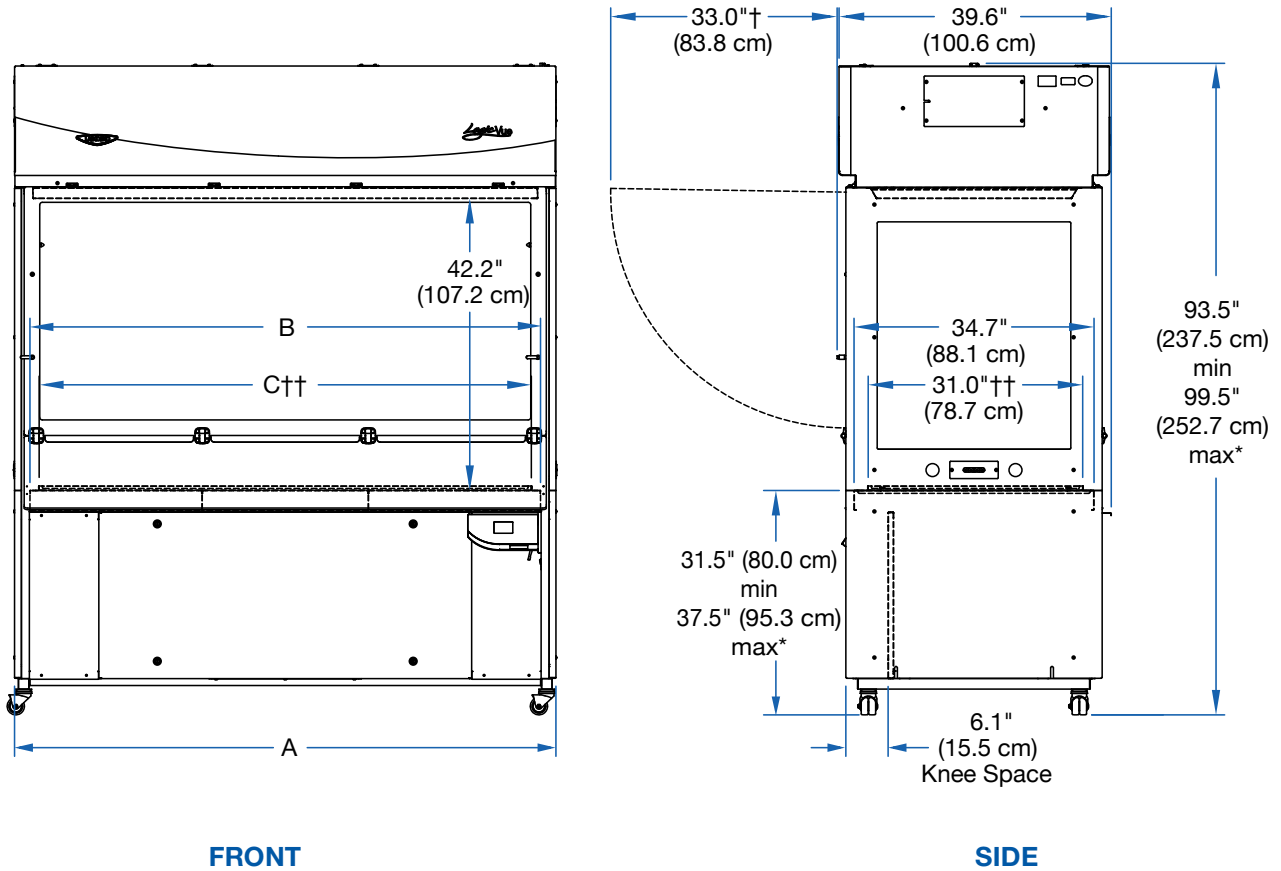

Model	Overall Width (A)	Maximum Interior Width (B)	Working Width (C)
6'	78.2" (198.6 cm)	73.8" (187.5 cm)	71.2" (180.8 cm)

*Adjustable in 1" (2.5 cm) increments.

†Swing clearance for Front Hatch. Same for Rear Hatch.

††Footing of instrumentation cannot exceed these dimensions. Maximum interior dimensions are 34.7" (88.1 cm) depth x 71.2" (180.8 cm) width.

NOTE: Logic Vue may be reduced in size to 77.5" (196.9 cm) height x 35.0" (88.8 cm) depth for passage through small doorways.

Logic® Vue Class II Enclosures

Specifications

All models feature:

- Intrinsically safe, single-pass negative pressure design
- Fully-opening front/rear sashes and side windows constructed of durable polycarbonate
- * 8.0" (20.3 cm) front lower sash opening with unrestricted access to full working area
- Unidirectional ISO Class 5 air or better
- HEPA filters, supply and exhaust, are 99.99% efficient or better on particles 0.3 microns or larger
- Individual HEPA filters are 100% scannable
- Pre-filters extend life of HEPA filters
- Spacious working area of 42.2" h x 31.0" d (107.2 x 78.7 cm)
- Loading height of 42.2" (107.2 cm)
- * MyLogic™ OS displayed on a full-color LCD screen with adjustable angle and touchpad controls
- * Smart-Start™ package automates blower and light functions for start-up and shut-down
- Energy-efficient electronically communicated motors (ECM)
- * Constant Airflow Profile (CAP) safe airflow monitoring system
- Electronic security lock
- * Robust multi-piece work surface accommodates equipment up to 250.0 lbs (113.4 kg) per every 2 feet (60.1 cm)
- 304 stainless steel interior
- Chemically-resistant epoxy powder-coated steel exterior
- * SpillStopper work surface tray
- * Ergonomic deep knee well
- * Adjustable work surface height of 31.5-37.5" (80.0-95.3 cm) in 1" increments (2.5 cm)
- * Remote monitoring via USB and dry contact relays
- * LED lighting illuminates work surface for maximum visibility of 133 footcandles (1432 lux)
- * Safety Interlock port for automated equipment
- * 16 cable/cord pass-through ports
- * 2 service fixture provisions per sidewall
- * 2 large pass-through provisions per sidewall
- * Ergotron® computer/media arm attachment point
- * Four transport casters and four seismic leveling feet
- Reduces to 77.5" h x 35.0" (196.9 x 88.9 cm) w for passage through small doorways
- * Ships fully assembled with minimal installation required
- One year warranty on parts and labor
- * Labconco exclusive feature.

Standards conformance & regulations:

- Meets or exceeds NSF/ANSI Standard 49 for product and personnel protection
- UL Standard 61010-1
- CAN/CSA 22.2 No. 61010-1
- ADA-compliant operation

Options include:

- 115V or 230V electrical configurations
- Factory-installed large access port(s)

All models require (not included):

- Dedicated electrical circuit (select based on model)
 - 100-115V, 50/60Hz: 30A circuit
 - 208-230V, 50/60Hz: 20A circuit

Optional accessories:

- Canopy Connection Kit
- Large Tubing Pass-Throughs (up to 2 per side)
- Service Fixtures (up to 2 per side)
- Airflow Sensor
- Safety Interlock Cable

**Contact your Avantor representative to request
information for all Labconco products.**

LABCONCO CORPORATION

©2021 LABCONCO CORPORATION

Printed in the U.S.A.

Product design subject to change without notice.

5-69-3/16/21



 **avantor**™
delivered by **VWR**™

VWR.COM

Prices, product, and/or services details are current when published and subject to change without notice. | Certain products or services may be limited by federal, state, provincial, or local regulations. | VWR, part of Avantor, makes no claims or warranties concerning sustainable/green products. Any claims concerning sustainable/green products are the sole claims of the manufacturer and not those of VWR International, LLC and/or Avantor, Inc. or affiliates. All prices are in US dollars unless otherwise noted. Offers valid in US and Canada unless otherwise noted, void where prohibited by law or company policy, while supplies last. | Trademarks are owned by Avantor, Inc. or its affiliates, unless otherwise noted. | Visit vwr.com to view our privacy policy, trademark owners, and additional disclaimers. © 2021 Avantor, Inc. All rights reserved.

0321 Lit No 120089W