

Valid for Item-No.: 658910, 658920, 658940, 658950

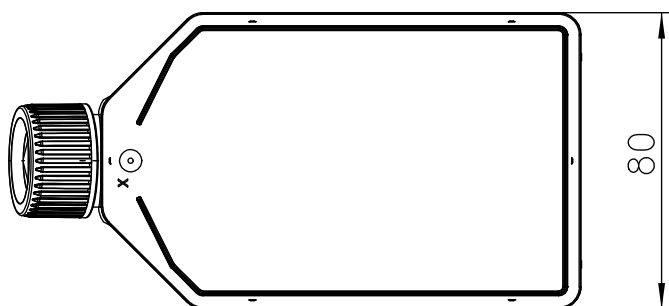
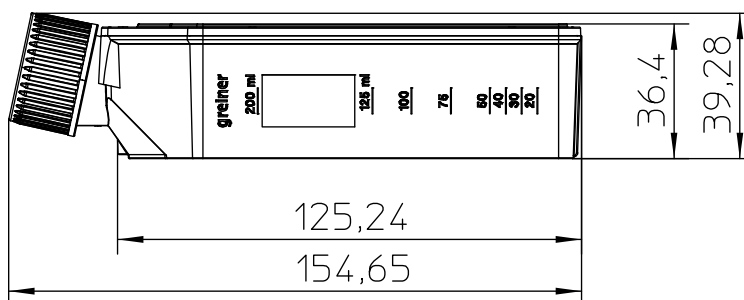
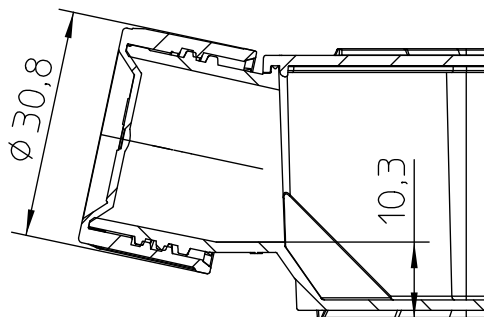

"All dimensions in mm"

Customer drawing subject to change without notice!

Uncontrolled Copy

Prior Issue	Drawn	Approved	Released	CONFIDENTIAL: Information contained in this document or drawing is confidential and proprietary to Greiner Bio-One GmbH. This document may not be reproduced for any reason without written permission from Greiner Bio-One GmbH. All rights of design, invention, and copyright are reserved.
Revision 1	Date 2011/03/04	Date 2012/04/18	Date 2012/04/18	
Date 2011/03/04	Name falter	Name falter	Name sonntag	