

Start up Guide

A-Series (NTEP)

Balance Series

1. CONTENT

Models: VWR-224AC.N | VWR-314AC.N

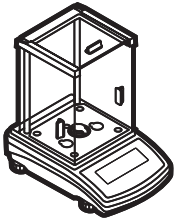

Balance
x 1



Weighing pan
x 1



Draft shield
x 1

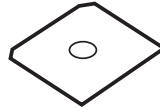

Bottom insert
x 1

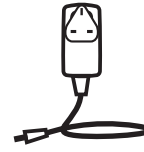

Power adapter
x 1

Models: VWR-363AC.N | VWR-1003AC.N

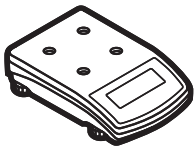

Balance
x 1



Weighing pan
x 1

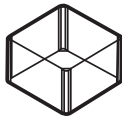

Draft shield
x 1



Grounding foot
x 1



Foot
x 3

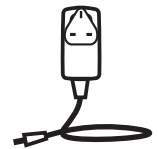

Power adapter
x 1

Models: VWR-2102AC.N | VWR-4502AC.N

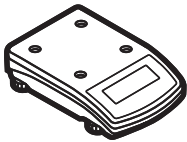

Balance
x 1



Weighing pan
x 1



Grounding foot
x 1



Foot
x 3

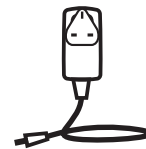

Power adapter
x 1

2. WORKROOM AND BASIC OPERATION GUIDELINES

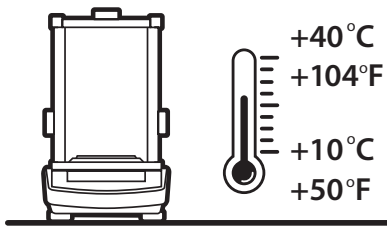

Operate the device in a room where the temperature ranges between 10–40 °C (50–104 °F) and where the relative humidity is below 80%.

Place the balance on a solid surface to ensure stability. To obtain stable and repeatable weighing results, an anti-vibration table is recommended.

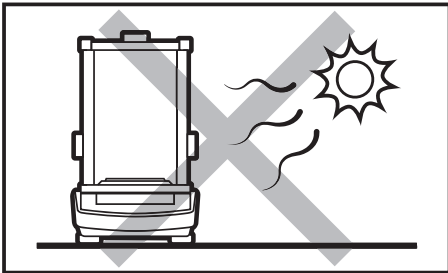

Place the balance away from heat sources. Avoid exposing the balance to the sunlight.

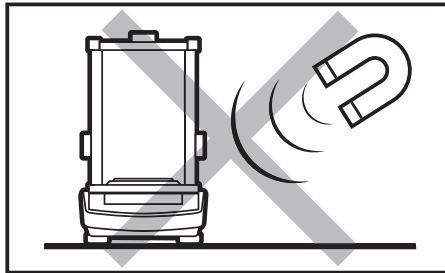

Avoid exposing the balance to a magnetic field. Do not weigh magnetic substances.

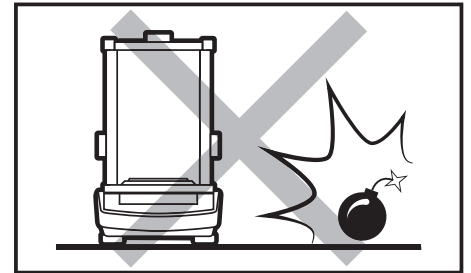

Do not place the balance in a hazardous area. Do not weigh explosive materials.

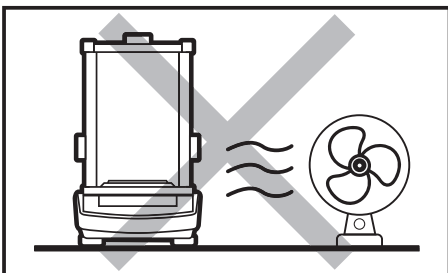

Avoid air drafts and air movements at the workstation.

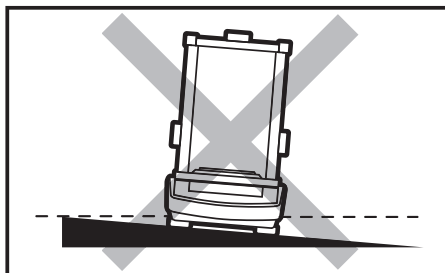

Make sure that the balance is placed on an even surface.

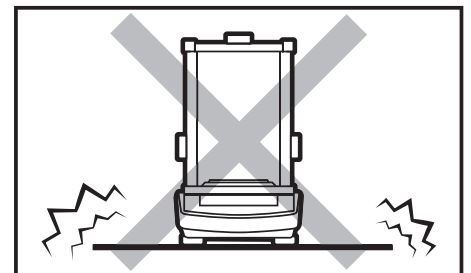

Do not place the balance on an unstable ground exposed to shocks and vibrations.

3. UNPACKING

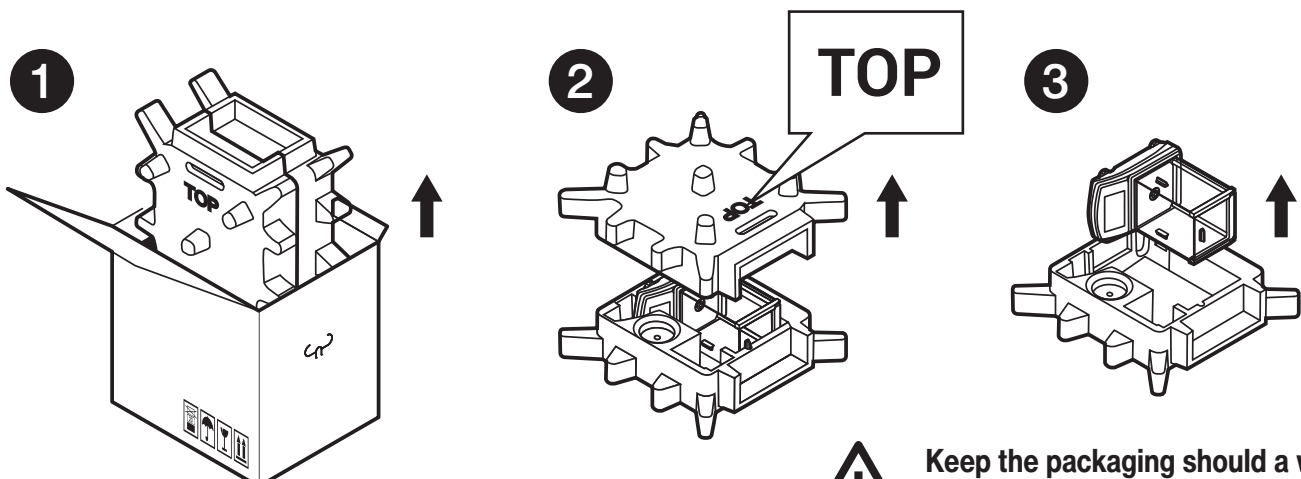

Keep the packaging should a warranty claim or service be required.

4. ACTIVITIES TO BE DONE PRIOR TO OPERATION

4.1. Remove transport lock

Models: VWR-224AC.N | VWR-314AC.N

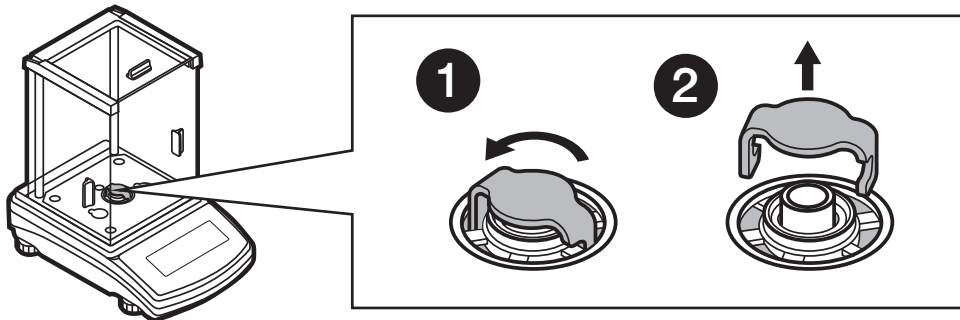

Keep the transport lock should a warranty claim or service be required.

Models: VWR-363AC.N | VWR-1003AC.N | VWR-2102AC.N | VWR-4502AC.N

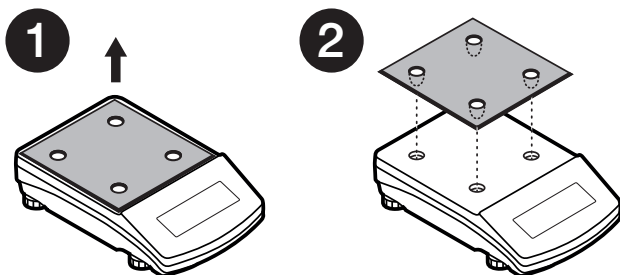

Keep the transport lock should a warranty claim or service be required.

4.2. Grounding spring check

Models: VWR-224AC.N | VWR-314AC.N

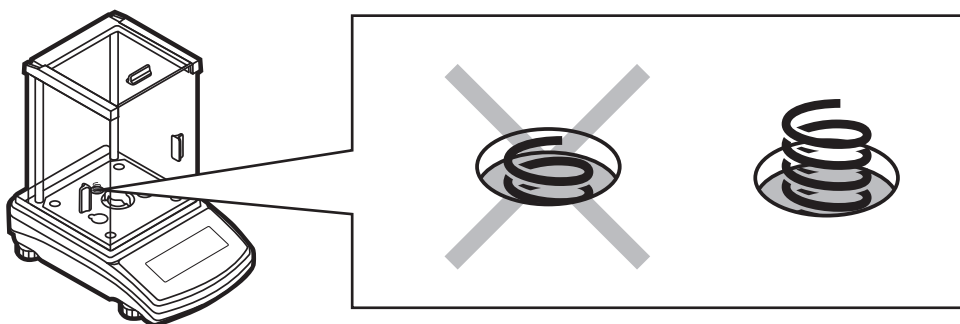

Check the grounding spring. Make sure that the grounding spring juts slightly out of the hole.

Models: VWR-363AC.N | VWR-1003AC.N | VWR-2102AC.N | VWR-4502AC.N

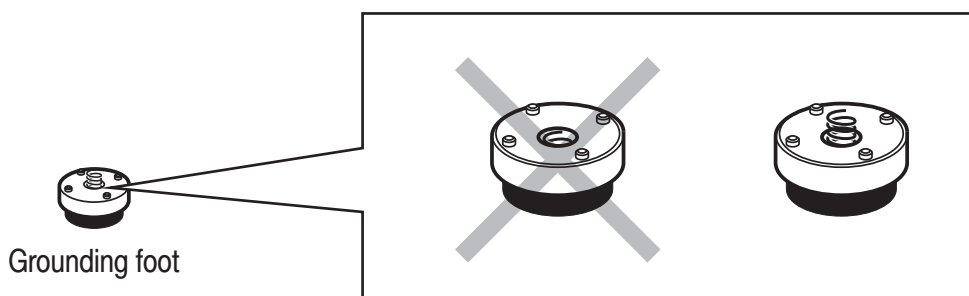

Check the grounding spring. Make sure that the grounding spring juts slightly out of the hole.

5. COMPONENTS ASSEMBLY

Models: VWR-224AC.N | VWR-314AC.N

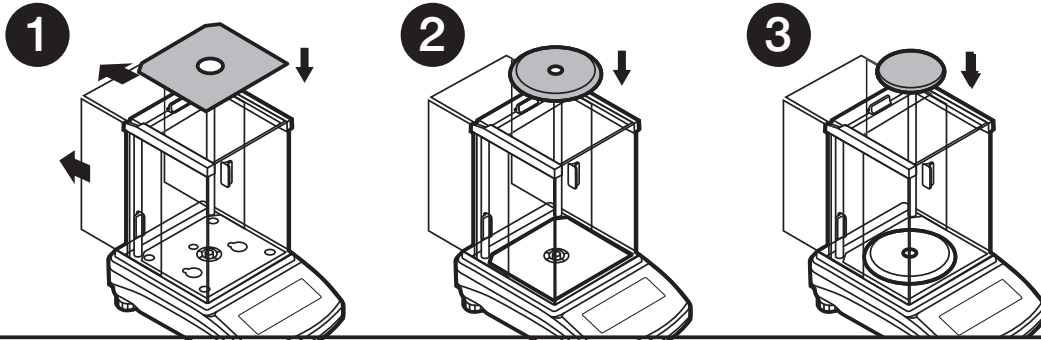

Models: VWR-363AC.N | VWR-1003AC.N

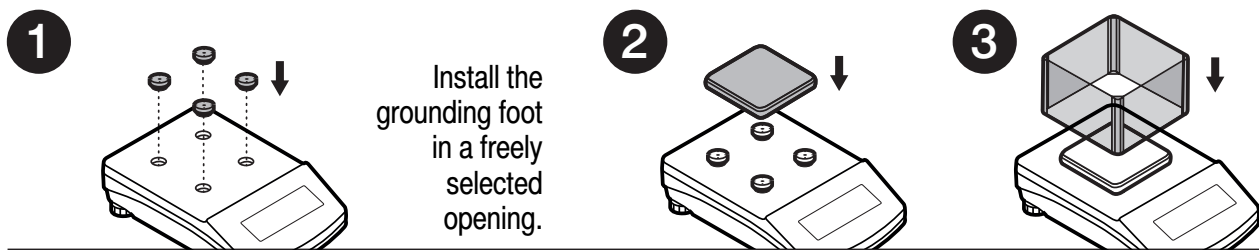

Models: VWR-2102AC.N | VWR-4502AC.N



6. PREPARING FOR WORK

6.1. Balance temperature stabilization time

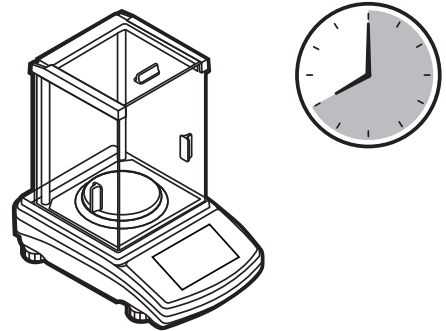
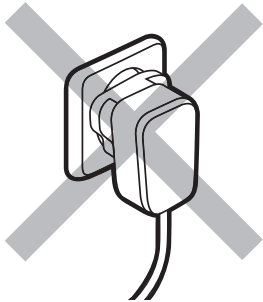

Prior to switching the device on it is necessary to ensure that it has reached a temperature equal to room temperature.

Balance temperature stabilization time ranges between 1 - 8 hours.

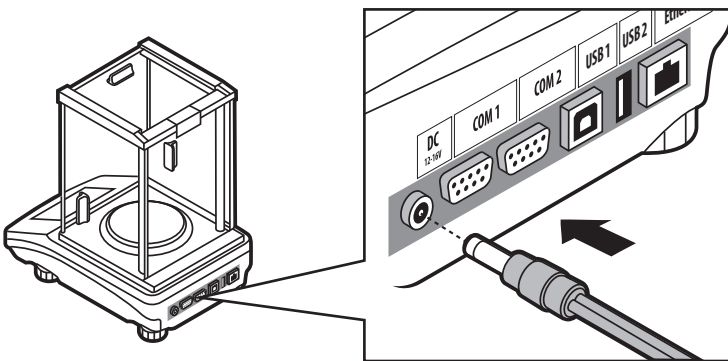

Connect the power adapter to DC connector.

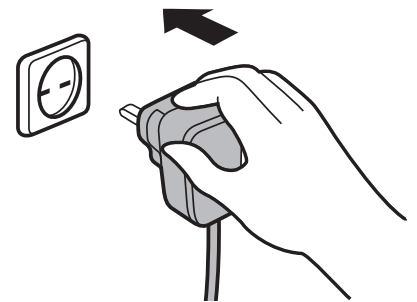

Connect the power adapter to the mains.

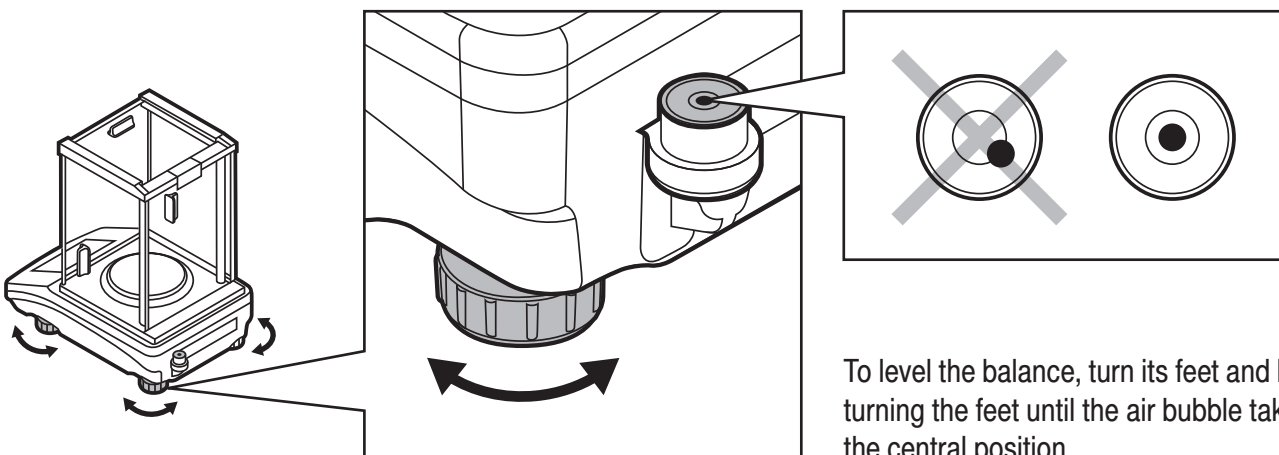

To level the balance, turn its feet and keep turning the feet until the air bubble takes the central position.

7. PANEL AND SCREEN

7.1. Panel keys

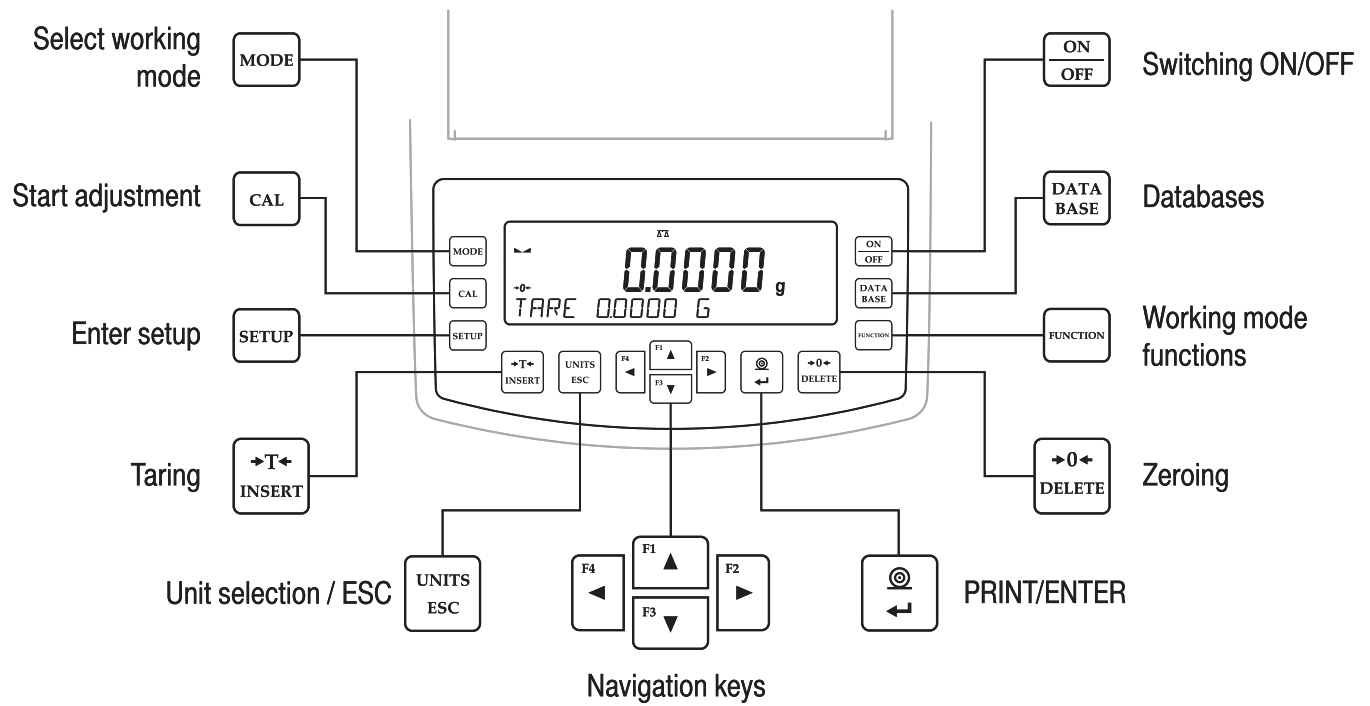

7.2. Home screen

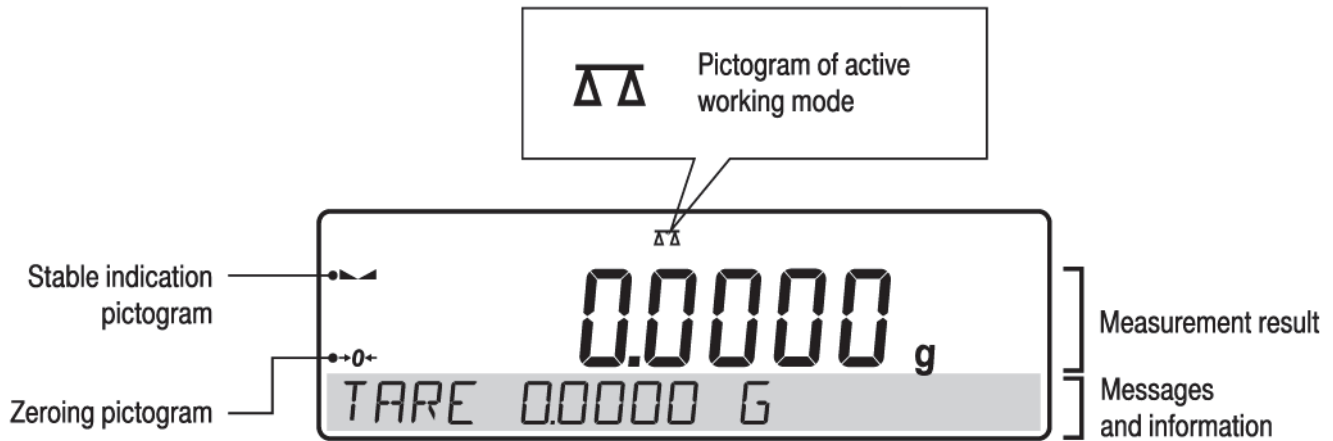

8. BASIC OPERATIONS

8.1. Adjustment

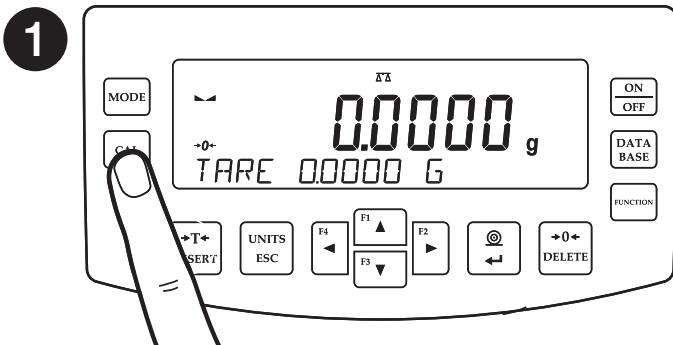

Press **CAL** key to start the adjustment

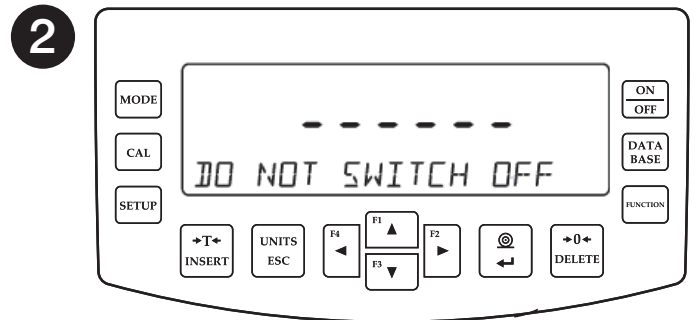

Wait for the adjustment completion.

8.2. Zeroing

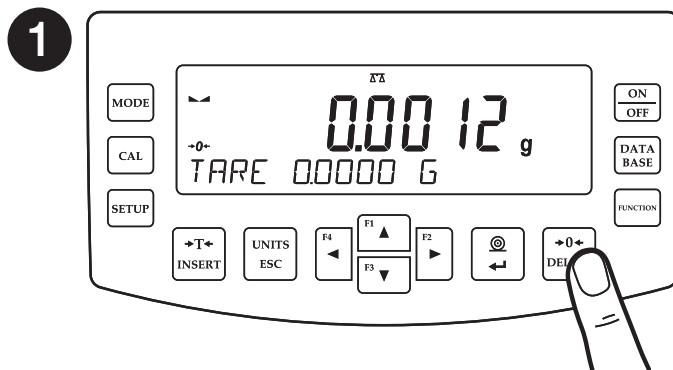

Unload the weighing pan and press "Zeroing" button.

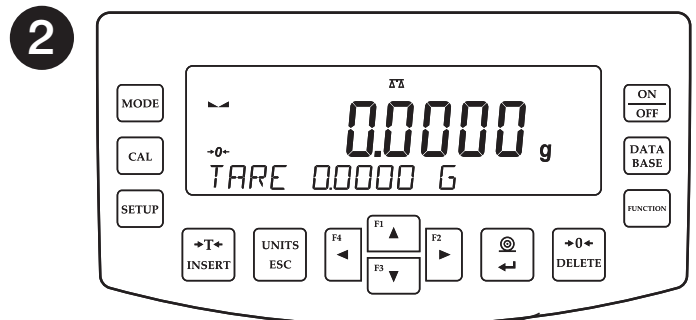

The balance has been zeroed.

8.3. Taring

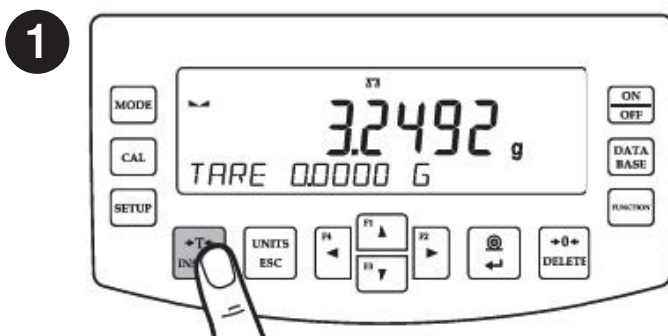

When the weighing result has been displayed press "Tare" button.

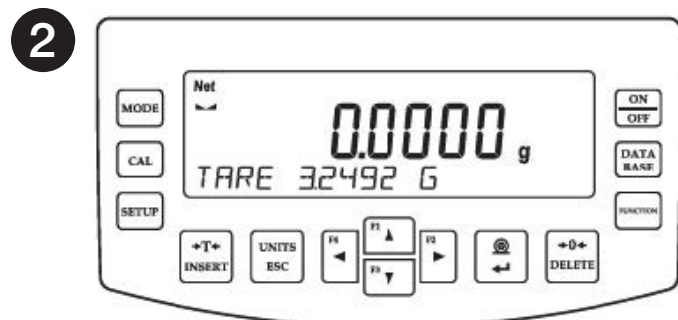

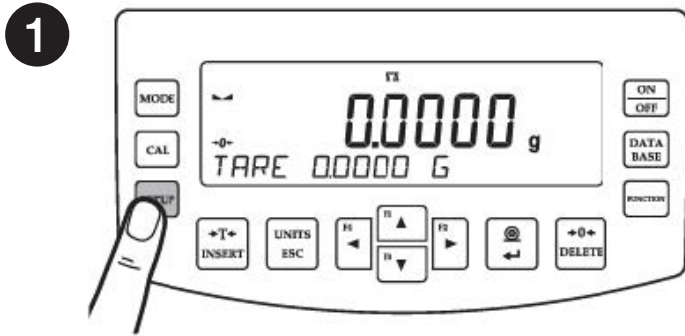

The balance has been tared.

8.4. Working modes accessibility

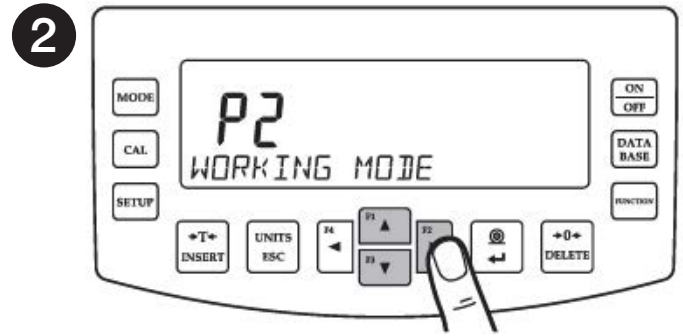

Press  to enter "Setup" menu.



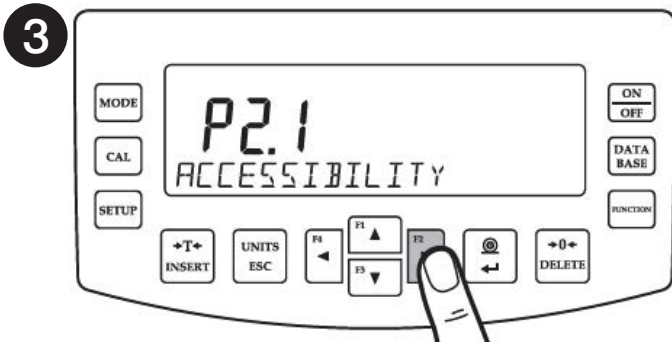

Using  keys select "Working mode" and press  key



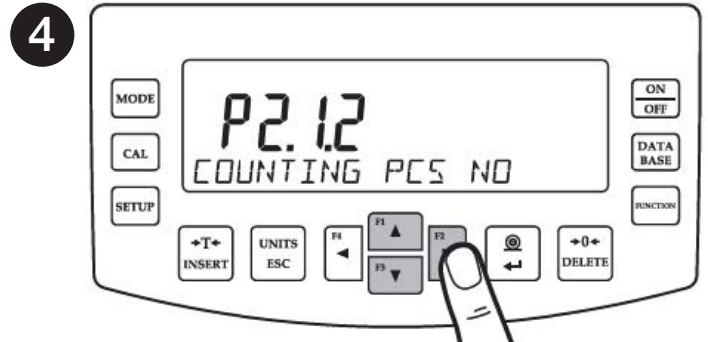

In the "Accessibility" position, press  key

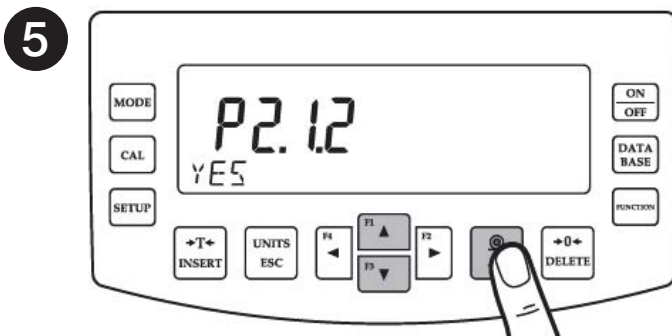

Using  keys to select working modes for which accessibility is to be set and press  key.



Using  keys to set accessibility parameter to "Yes" value for a selected working mode and press  key to confirm.

 In order to enable other working modes, repeat the steps: **4** and **5**.

8.5. Selecting working mode

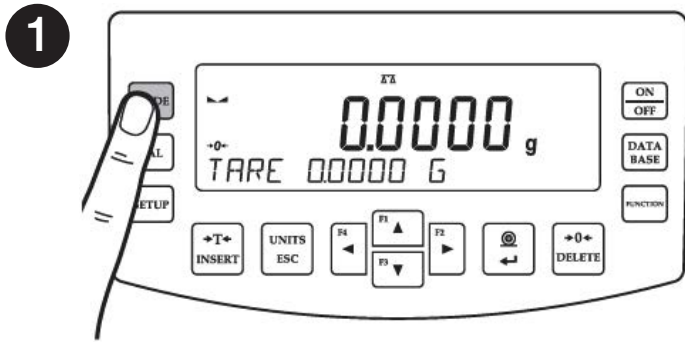

Press **MODE** key to enter working modes menu.

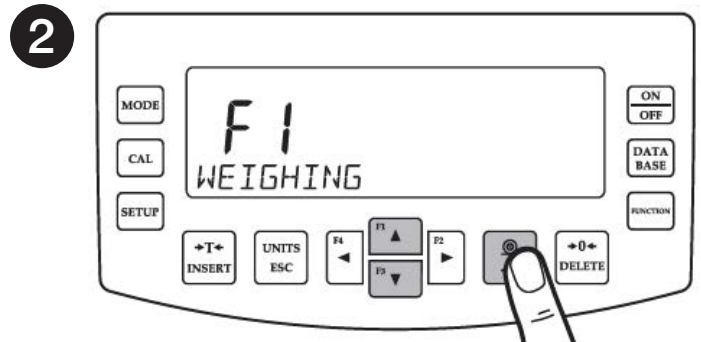

Using **F1** keys, select working mode and press **ENTER** key to confirm.

The menu features the following working modes:

- Weighing
- Parts counting
- Checkweighing
- Dosing
- Deviations
- Density Determination of Solids
- Density Determination of Liquids
- Statistics
- Totalising
- Peak Hold
- Pipettes Calibration



Detailed overview of the settings of the working modes is to be found in balance's main user manual.

8.6. Weighing unit accessibility

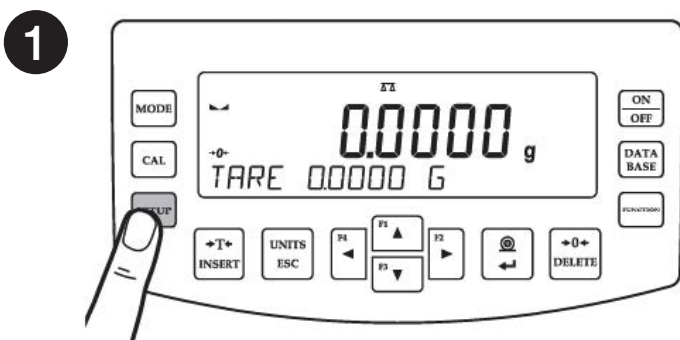

Press **SETUP** to enter "Setup" menu.

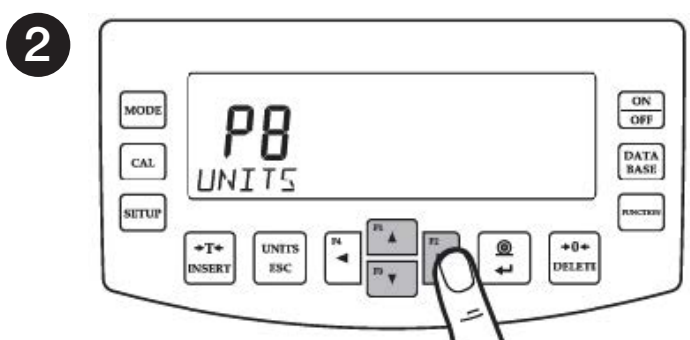

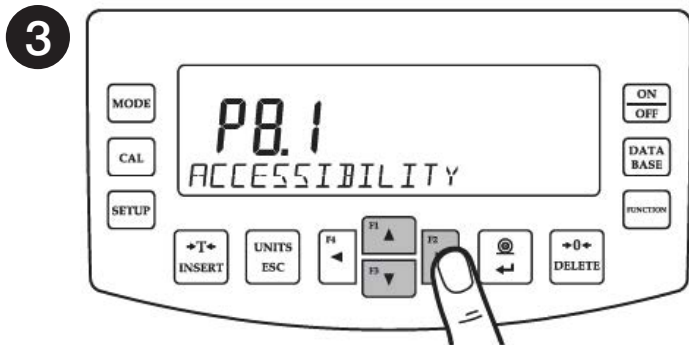

Using **F2** keys, select "Units" and press **F2** key



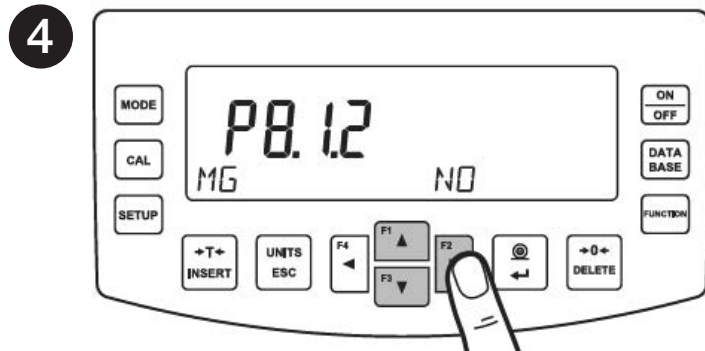



In the "Accessibility" position, press 



Using   keys to select unit for which accessibility is to be set and press  key.



Using   keys to set accessibility parameter to "Yes" value for a selected working mode and press  key to confirm.

 In order to enable other working modes, repeat the steps: **4** and **5**.

8.7. Weighing unit selection

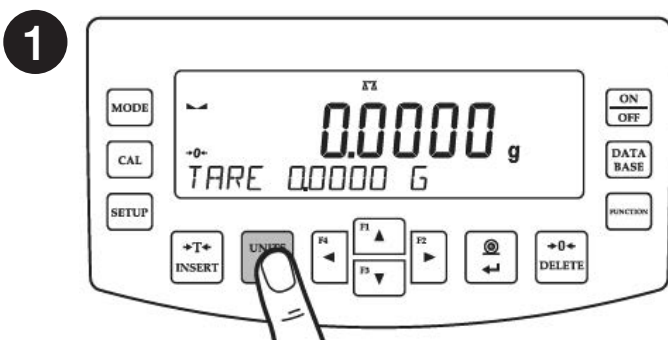

Press  key to select the weighing units

The balance enables selecting the following weighing units:

- Gram [g]*
- Miligram [mg]*
- Kilogram [kg]*
- Carat [ct]*

9. SETTINGS



Some balance settings are accessible for Administrator exclusively. Prior balance parameters setup, log in as the Administrator.

9.1. Administrator's login

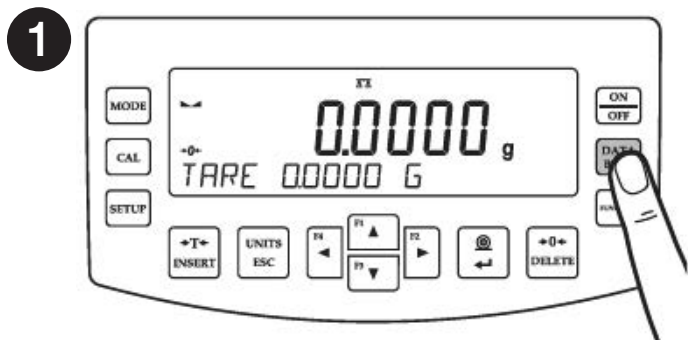

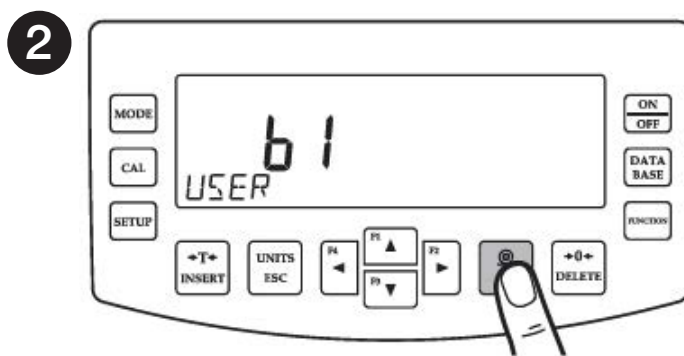

Press  key to enter "Database" menu



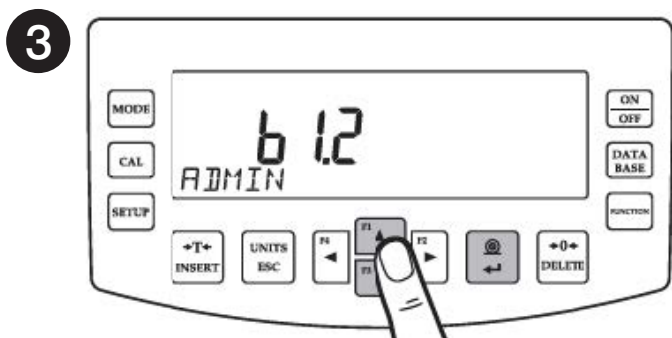



To enter user parameters, press  key

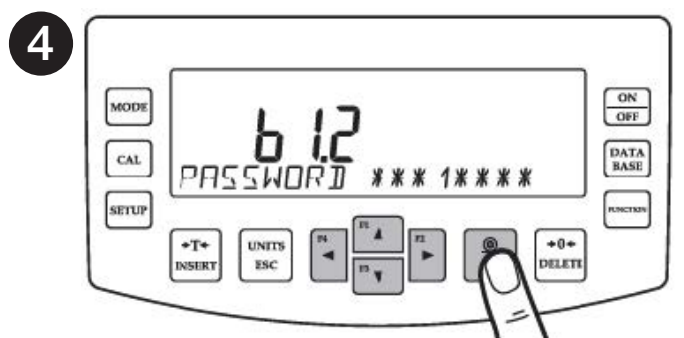

Using   keys select "Admin" and press  key to confirm



Using    keys select "1111" and press  key to confirm.

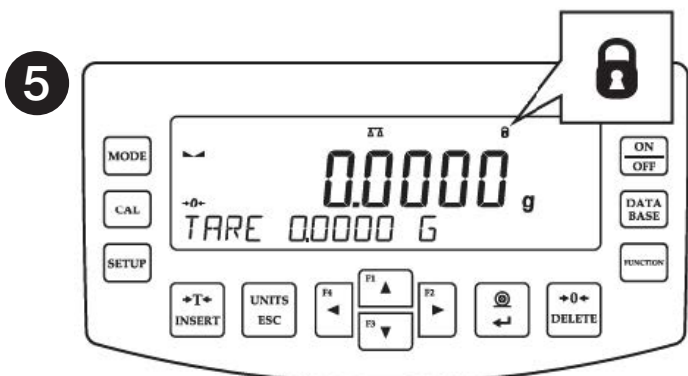

You have logged in as the administrator.



Upon logging in pictogram is displayed 

9.2. User settings



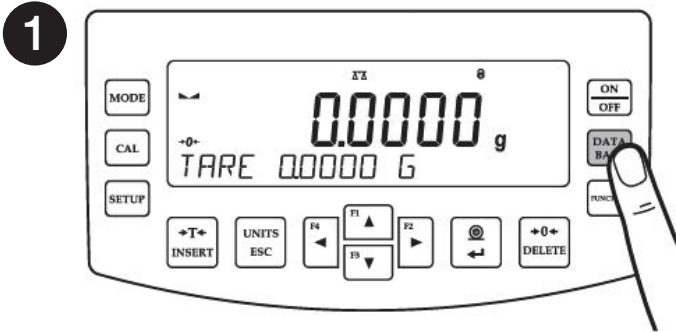

Prior balance users setup, log in as the Administrator.

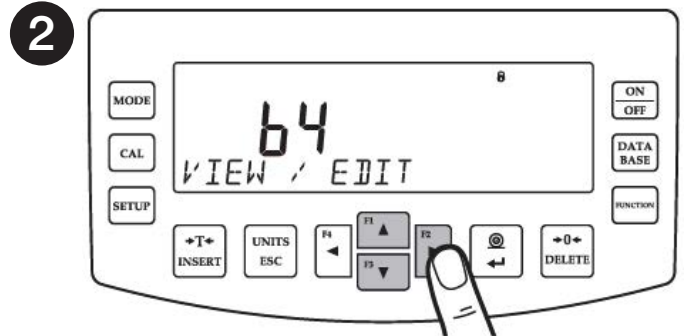

Press  key to enter "Database" menu



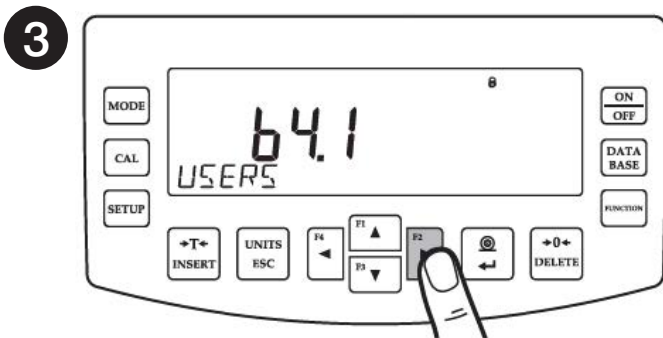

Using   keys to select "View/Edit" and press  key to confirm

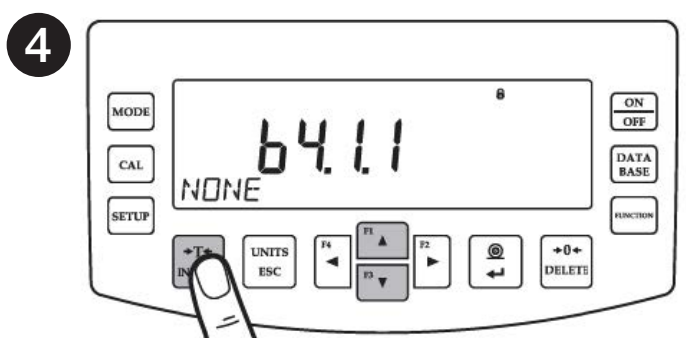

To select "Users" parameters, press  key



Using   keys select "Admin" and press  key to confirm



Press  key to add new user.



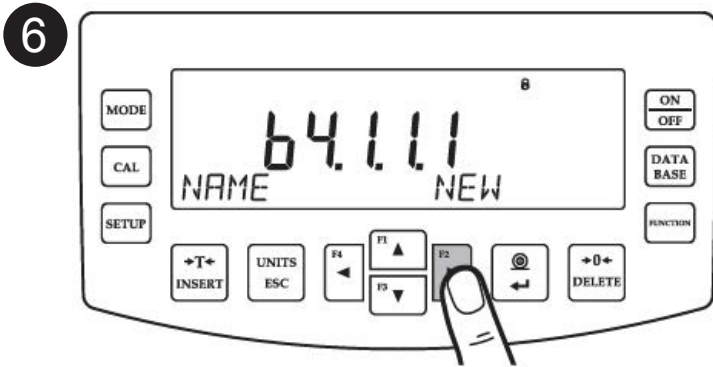

In the following steps, set:

- User name
- Code
- Password
- Permissions level
- Language

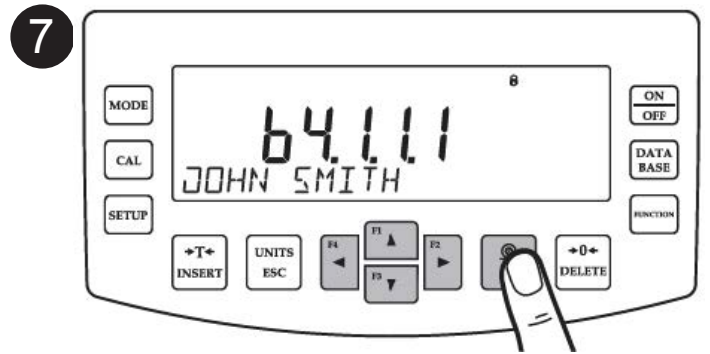

Press  key to add new user.





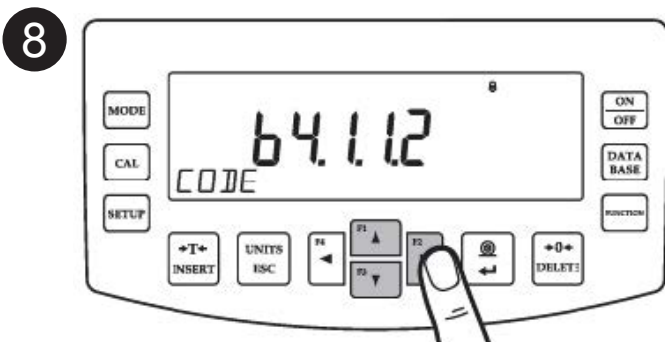

Using    keys to enter user name and press  key to confirm

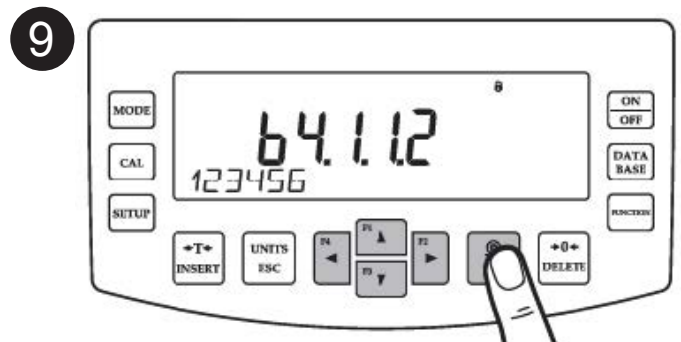



Using   keys select "Code" and press  key



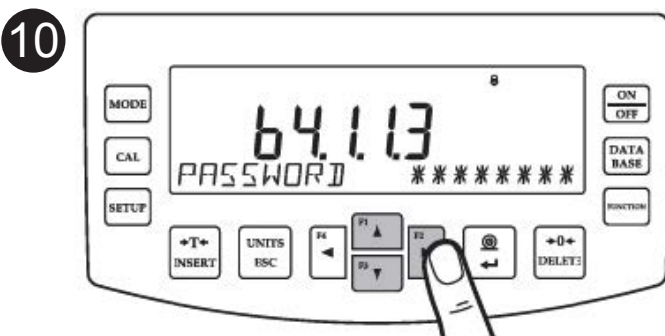



Using    keys enter user code and press  key to confirm

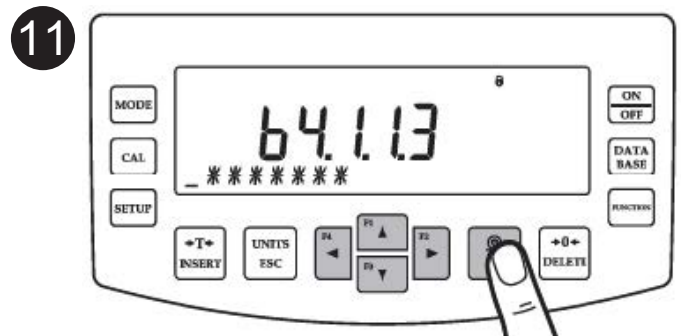



Using   keys select "Password" and press  key to confirm



Using    keys enter user password and press  key to confirm

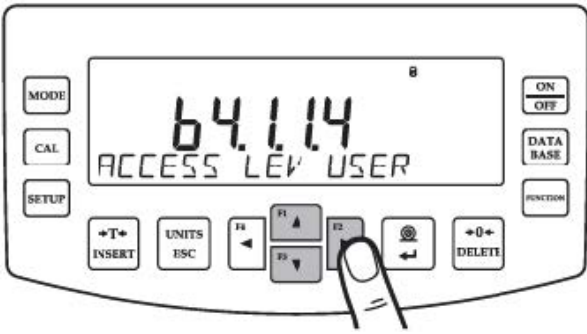

12



Using  keys select "Access Level" and press  key to confirm.

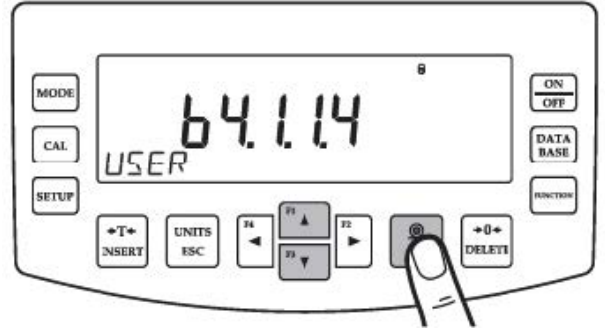

13



Using  keys select permissions level and press  key to confirm.

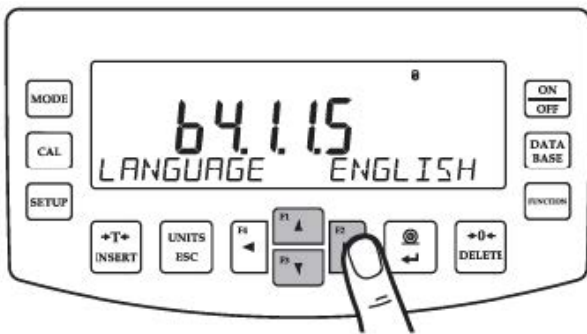

14

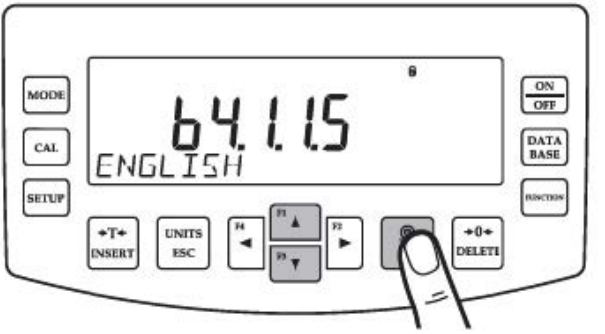

Using  keys select "Language" and press  key to confirm

15



Using  keys to select menu language press  key to confirm.

10. PERIPHERAL DEVICES CONNECTORS

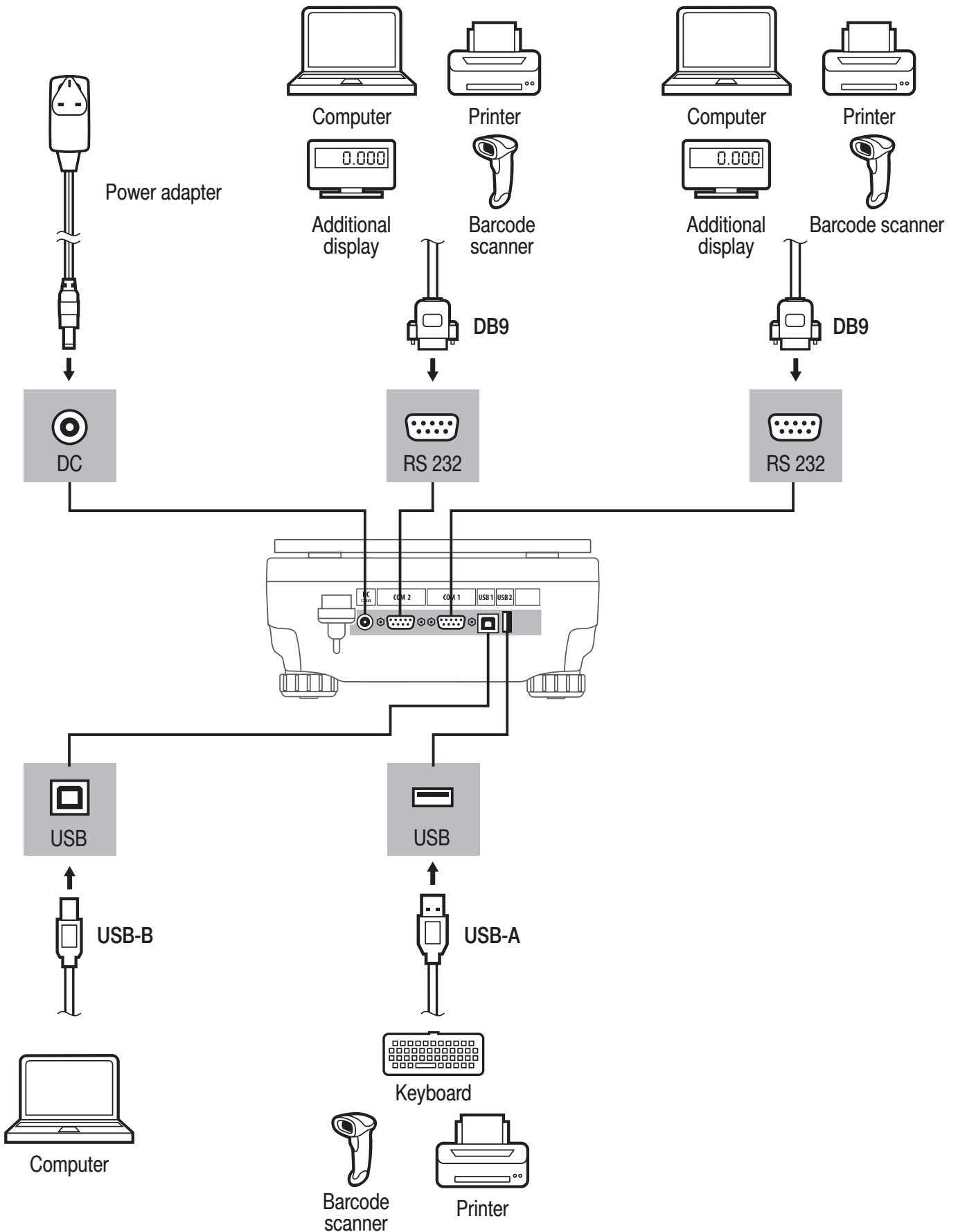

11. DEVICE CLEANING

11.1. General Recommendations

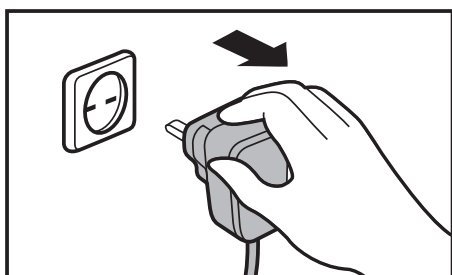

Prior to cleaning, it is necessary to disconnect the balance from the mains.

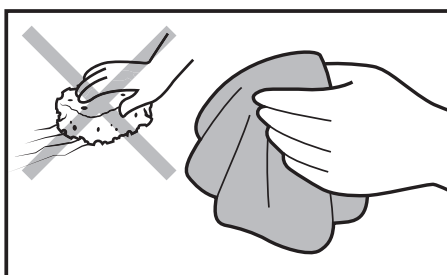

Use soft cloths made of microfiber, natural fiber or man-made fiber. Avoid using abrasive cloths or cloths that might scratch the surface.

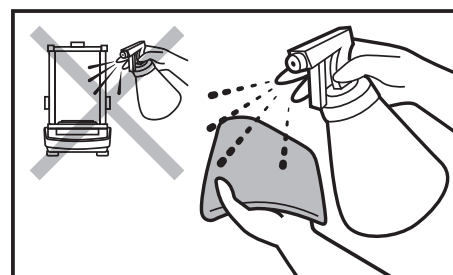

Apply the cleanser onto the cloth first. Avoid applying the cleanser directly onto the device.



Avoid using cleansers containing chlorine, corrosive chemicals and bleach. Do not use cleansers containing abrasive substances or scouring preparations.

11.2. Glass components

Prior to cleaning the glass panes, it is necessary to disassemble them first. For detailed instruction on panes disassembly, refer to user manual.

Clean glass components using a solution of water and detergent (liquid soap, dish-washing detergent, glass cleaner, etc.). In case of heavy contamination, a mild solution of vinegar or baking soda can be used.

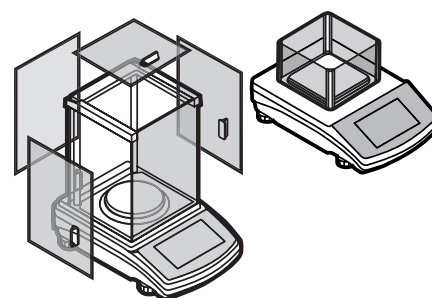

11.3. Plastic components

Prior to cleaning the plastic housing, it is necessary to disassemble weighing pan components (cover, weighing pan, etc.).

Clean plastic components using a solution of water and detergent (liquid soap, dish-washing detergent, glass cleaner, etc.).

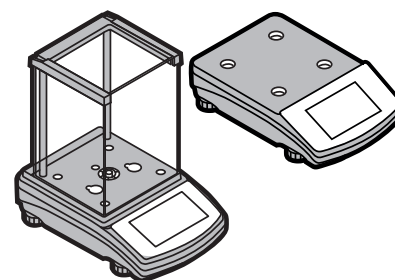

11.4. Stainless steel components

Prior to cleaning the stainless steel components, it is necessary to disassemble them first.

Clean stainless steel components using a solution of water and detergent (liquid soap, dish-washing detergent, glass cleaner, etc.). In case of heavy contamination, a mild solution of vinegar or baking soda can be used.

