



PHC705

Safety information

⚠ WARNING	
	Chemical exposure hazard. Obey laboratory safety procedures and wear all of the personal protective equipment appropriate to the chemicals that are handled. Refer to the current safety data sheets (MSDS/SDS) for safety protocols.
⚠ CAUTION	
	Personal injury hazard. Glass components can break. Handle with care to prevent cuts.

Precautionary labels

Read all labels and tags attached to the instrument. Personal injury or damage to the instrument could occur if not observed. A symbol on the instrument is referenced in the manual with a precautionary statement.

	Electrical equipment marked with this symbol may not be disposed of in European domestic or public disposal systems. Return old or end-of-life equipment to the manufacturer for disposal at no charge to the user.
------------------------------------------------------------------------------------	---------------------------------------------------------------------------------------------------------------------------------------------------------------------------------------------------------------------

Specifications

Specifications are subject to change without notice.

Specifications	Details
Probe type	Digital combination glass pH probe with refillable electrolyte and built-in temperature sensor
Body material	Glass
pH range	pH 0 to 14
pH resolution	User-selectable stabilization time and resolution—Fast: 0.1, Fast: 0.01, Medium: 0.01, Slow: 0.01 or Slow: 0.001
pH accuracy	±0.01 pH
Sodium (alkalinity) error	<0.3 pH at pH 13 in 0.1 M NaOH
Slope	−59 mV/pH (85 to 115% at 25 °C (77 °F) per Nernstian theoretical value)
Isopotential point	pH 6.00
Temperature compensation	30 kΩ NTC thermistor
Temperature accuracy	±0.3 °C (±0.54 °F)
Operating temperature	−10 to 100 °C (14 to 212 °F)
Storage temperature	5 to 40 °C (41 to 104 °F)
Junction type	Porous pin
Reference type	Red Rod ¹
Electrolyte	Refillable, saturated KCl

Specifications	Details
Storage solution	Saturated KCl
Minimum sample depth	18 mm (0.71 in.)
Dimensions	Body diameter: 12 mm (0.47 in.) Body length: 103 mm (4.1 in.) Total length: 200 mm (7.87 in.) Cable length: 1 m (3.28 ft)
Cable connection	M12 digital output and connector compatible with HQd meters

¹ Radiometer Analytical's Red Rod technology: Encapsulation of reference elements with a red protection tube.

Product overview

The probe is a digital pH combination electrode with refillable electrolyte, a glass body and an integrated temperature sensor. The probe is for laboratory use and measures pH in general aqueous samples.

Note: Do not use the probe with organic solvents, emulsions, samples with high solids content or high alkaline sample types.

A 59-mL bottle of reference electrolyte filling solution (saturated KCl solution) is included with the probe. Refer to [Figure 1](#).

Figure 1 Probe overview

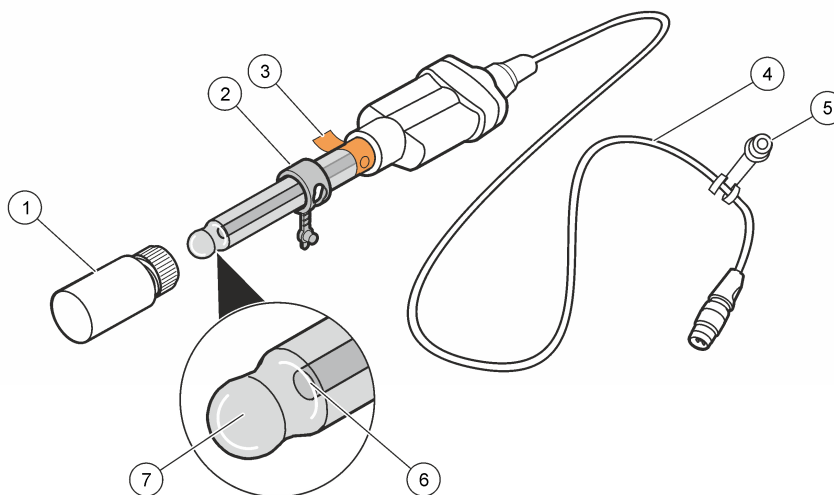

1 Probe soaker bottle	5 Probe soaker bottle holder
2 Filling-hole cap	6 Reference junction
3 Protective tape and filling-hole	7 Glass bulb and temperature sensor
4 Cable, 1 meter (3.28 ft)	

Preparation for use

Prepare the probe before a calibration or a sample measurement.

1. Turn the probe soaker bottle cap counter-clockwise to loosen the cap.
2. Remove the soaker bottle from the probe.
3. Fully rinse the reference junction and the glass bulb with deionized water to remove all of the storage solution or possible salt particles. Dry with a no-lint cloth.
4. Remove the protective tape from the filling hole before initial use (refer to [Product overview](#) on page 2). Discard the protective tape.

5. Add the filling solution to the probe as necessary (refer to [Fill the probe](#) on page 11). The filling solution must be above the standard solution or the sample level during measurement or calibration ([Figure 2](#)).
6. For Red Rod probes, make sure that there is approximately 0.5 cm (0.2 in.) of KCl crystals in the filling solution in the probe. Refer to [Table 1](#). For measurements at temperatures higher than 60 °C (140 °F), add KCl crystals through the filling hole. Refer to [Table 1](#) to calculate the quantity of KCl crystals to add. The quantity of necessary KCl crystal increases linearly from 60 to 100 °C.
7. For Red Rod probes, make sure that the KCl crystals move freely through the liquid when the probe is inverted. If necessary, shake the probe to loosen the crystals.
8. Make sure that the filling hole is open during measurement for the correct flow of the filling solution.

Note: For the best stabilization time, condition the probe for 2 hours in pH buffer 4.01 before use, if the probe was not used for 3 weeks or more. In low ionic strength (LIS) samples, condition the probe for a maximum of 5 minutes in the sample before use. In all other cases a condition before use is not necessary.

Figure 2 Filling solution level

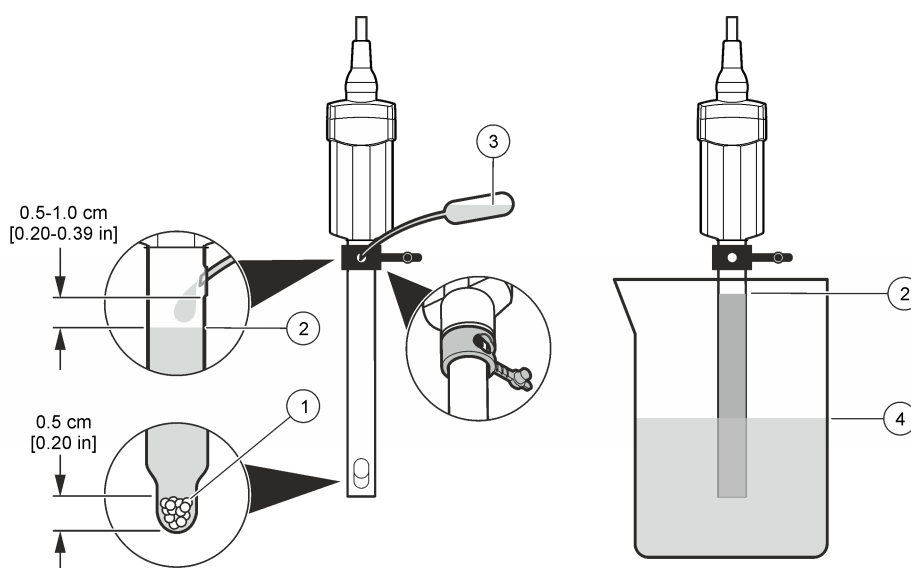

1 KCl crystals ¹	3 Filling solution
2 Filling solution level	4 Standard solution or sample level

¹ Red Rod probes only

Table 1 KCl crystal level for Red Rod pH probes

Temperature	Amount of KCl crystals	Add	Temperature	Amount of KCl crystals	Add
60 °C (158 °F)	0.5 g (0.5 cm)	0 g	90 °C (194 °F)	0.875 g	0.375 g
70 °C (158 °F)	0.625 g	0.125 g	100 °C (212 °F)	1.0 g (1.0 cm)	0.5 g
80 °C (176 °F)	0.750 g	0.25 g			

Calibration

Before calibration:

The probe must have the correct service-life time stamp. Set the date and the time in the meter before the probe is attached.

It is not necessary to calibrate again if a calibrated probe is moved from one HQd meter to another. Make sure that the additional meter is configured to use the same calibration options.

Before calibration:

To view the calibration data, push , then select View Probe Data>View Current Calibration.

If two probes are connected, push the **UP** or **DOWN** arrow to change to the single display mode to show the Calibrate option (available only on HQ40d and HQ440d meters).

Prepare the probe for use (refer to [Preparation for use](#) on page 2).

Calibration notes:

- Use buffers that are two pH units apart.
- Select additional standard sets with the minimum number of calibration points in the Calibration Options. For a two-point calibration, select: one buffer with a pH above and one buffer with a pH below the sample pH. For a one-point calibration, select the buffer nearest to the sample pH.
- The calibration is recorded in the probe and the data log. Send the calibration to a PC, a printer or a flash memory stick if connected.
- Air bubbles under the sensor tip can cause a slow response or an error in the measurement. If there are bubbles under the sensor tip, carefully shake the probe to remove the bubbles.
- Make sure that the filling hole is open and above the sample solution level.
- Use a laboratory stirrer or shake the probe from side to side in the solution to refresh the reference junction.
- The meter display shows "Stabilizing" and a progress bar as the probe stabilizes in the standard. The display shows the buffer and the temperature corrected pH value when the measurement is stable.
- The calibration and sample measurement conditions must be as similar as possible (e.g., the temperature of the solution, the stir procedure, the stir rate and the position of the probe).
- If a calibration error occurs, refer to [Troubleshooting](#) on page 12.

Calibration procedure:

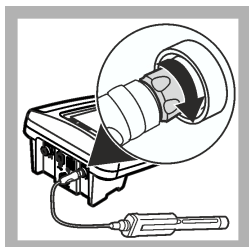

1. Connect the probe to the meter. Make sure that the cable locking nut is correctly connected to the meter. Set the meter to on.



2. Push **Calibrate**. The display shows the buffers that are necessary for calibration.

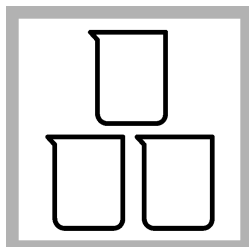

3. Prepare the fresh buffers in separate beakers or applicable containers.

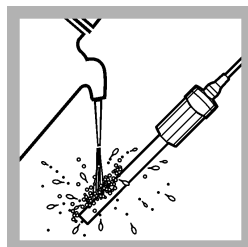

4. Rinse the probe with deionized water. Dry with a no-lint cloth.

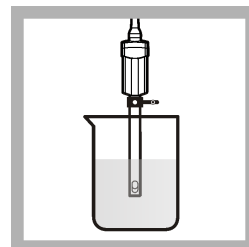

5. Put the probe in the pH buffer solution and stir lightly. Make sure to fully put the reference junction into the standard.

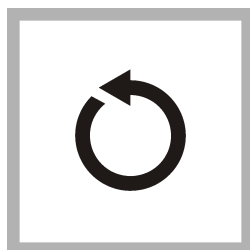

6. Push **Read**. Wait until the reading stabilizes.

7. Do steps 4–6 again to collect the minimum number of calibration points specified in the calibration options.

8. Push **Done** to view the calibration summary.

Note: *The display will not show "Done" until the minimum number of calibration points is collected.*

9. Push **Store** to accept the calibration and go back to the measurement mode.

Sample requirements

NOTICE

Some probes are not compatible with specific sample types. Probe damage can occur.

- Samples must be aqueous. The probe can also make measurements in partially aqueous or some water-miscible solvents. Read the results with caution because the full pH scale changes when the solvent system changes.
- Probes with a Red-Rod reference system are compatible with solutions that contain silver complexing or binding agents (e.g., TRIS, proteins and sulfides), as they have an encapsulated reference system.
- Proteins can collect on the sensing element. Make sure that the probe stays clean when these types of samples are measured.
- Do not use the probe in solutions that are out of the temperature range of the probe. Refer to [Specifications](#) on page 1.
- For low ionic strength (LIS) or high purity samples, use an LIS chamber or a flow cell to prevent sample contamination.

Measurement

Before measurement:

The probe must have the correct service-life time stamp. Set the date and the time in the meter before the probe is attached.

If the complete traceability is necessary, enter a sample ID and an operator ID before the measurement. Refer to the HQd meter manual for more information.

A regular calibration is necessary for the best measurement accuracy (refer to [Calibration](#) on page 3).

Prepare the probe for use (refer to [Preparation for use](#) on page 2).

Measurement notes:

- Data is automatically stored in the data log when **Press to Read** or **Interval** is selected in the Measurement Mode. When **Continuous** is selected, data is only stored when **Store** is pushed.
- Air bubbles under the sensor tip can cause a slow response or an error in the measurement. If there are bubbles under the sensor tip, carefully shake the probe to remove the bubbles.
- For the best stabilization time, condition the probe for several minutes in the sample or in a solution comparable to the sample in terms of pH and ionic strength before the initial sample measurement.

- Do not put the probe on the bottom or sides of the container.
- Make sure that the filling hole is open and above the sample solution level.
- Use a laboratory stirrer or shake the probe from side to side in the solution to refresh the reference junction.
- The meter display shows "Stabilizing" and a progress bar as the probe stabilizes in the sample. The display shows the lock icon when the measurement is stable.
- If a measurement error occurs, refer to [Troubleshooting](#) on page 12.

Measurement procedure:

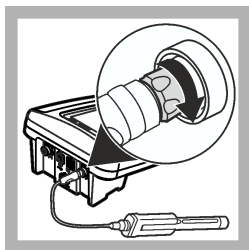

1. Connect the probe to the meter. Make sure that the cable locking nut is correctly connected to the meter. Set the meter to on.

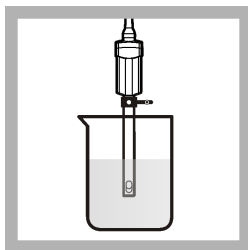

2. Condition the probe in the sample.

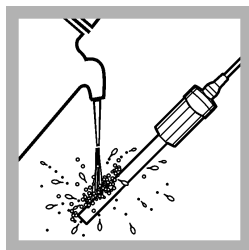

3. Rinse the probe with deionized water and then with the sample. Dry with a no-lint cloth.

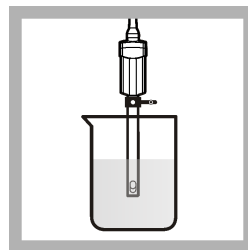

4. Put the probe in the sample and stir lightly. Make sure to fully put the reference junction into the sample.



5. Push **Read**. Wait until the reading stabilizes.

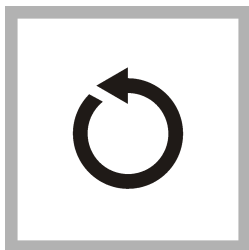

6. Do steps 3–5 again to make more measurements.

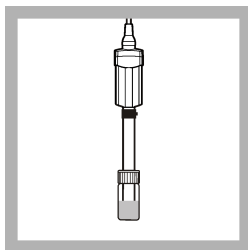

7. When measurements are done, put the probe in storage (refer to [Storage](#) on page 11).

Run Check Standard

The Run Check Standard feature validates the instrument performance between sample measurements. Use the Run Check Standard feature for a periodic or a user-defined interval measurements of a traceable standard solution. Set the criteria for check standards from the PHC705 Settings menu.

Note: Access control must be set to off or a valid password must be used to change the Run Check Standard options.

1. Push . The Full Access Options menu shows.
2. Select Run Check Standard.
Note: Select the correct probe if two probes are connected to the meter.
3. Use the standard solution shown on the display.
4. Rinse the probe with deionized water. Dry the probe with a no-lint cloth.
5. Put the probe in the standard solution. Make sure that the reference junction is fully in the standard. Move the probe up or down or lightly shake the probe to remove air bubbles.

6. Push **Read**. The display shows "Stabilizing" and a progress bar as the reading stabilizes. The display shows the value of the check standard and Check Standard Passed or Check Standard Failed.
7. If the display shows **Check Standard Passed**, the check standard measurement is in the accepted limits. Select **Done** to continue the sample measurement.
8. If the display shows **Check Standard Failed**, the measurement is out of the accepted limits. A calibration is recommended. Make sure that the limits are set correctly at the PHC705 Settings menu. If the acceptance criteria is set to "Cal Expires on Failure: Yes", the display shows the calibration icon and a question mark until the probe is calibrated again. To correct the probe calibration and status indicator, calibrate the probe (refer to [Calibration](#) on page 3).

Advanced operation

This section gives instructions about menu navigation and available options. Change parameter-specific settings through the Full Access Options menu.

The settings that can be changed are shown in [Table 2](#).

Table 2 Parameter-specific settings

Setting	Options
Measurement Options	<ul style="list-style-type: none"> • Resolution • Upper and lower range limits
Calibration Options	<ul style="list-style-type: none"> • Buffer set • Buffer set values (if Custom Buffer Set selected) • Reminder • Minimum Cal points • Slope limit
Check Standard Options	<ul style="list-style-type: none"> • Standard (temperature compensated buffer or custom at 25 °C (77 °F)) • Reminder • Acceptance criteria • Standard value at 25 °C (77 °F) (if custom standard selected)
Units	<ul style="list-style-type: none"> • pH • mV

Change measurement options

Methods are groups of default or user-defined settings related to specific applications. If the meter is set to the default method, a prompt for a new name method shows. The settings are saved with this name to identify them from the default method settings, which cannot be changed. Use a saved method as an alternative of many adjustments to the individual settings. Changes made to a user-defined method are automatically saved with the existing name. Save different methods for the same probe on each meter.

1. Make sure that a probe is connected to the meter.
2. Push  and select PHC705 Settings.
3. Select Modify Current Settings.
4. Select Units. Select pH (default) or mV.
Note: Use the mV option to find the probe offset in a pH 7 buffer or to measure the slope. Both units show when the Detail Display mode is selected.

5. Select Measurement Options and update the settings:

Option	Description
Resolution	<p>Set the resolution:</p> <ul style="list-style-type: none"> • 0.1 pH—Fast • 0.01 pH—Fast (default) • 0.01 pH—Medium • 0.01 pH—Slow, or • 0.001 pH—Slow <p>The resolution has an effect on the number of decimal digits and the stabilization time. More stabilization time is necessary for higher resolution measurements. Slower stabilization times give higher accuracy measurements.</p>
Measurement Limits	<p>Set the measurement limits—Lower limit (default: 0.00 pH) or Upper limit (default: 14.00 pH).</p> <p>Set the measurement limits to agree with the permitted values for the sample. When the measurement is above the upper limit setting or below the lower limit setting, the meter shows an "Out of limits" message. This message is an alert to a possible problem with the process conditions.</p>

6. If prompted, enter a name for the new method settings. Other changes made to the settings of an existing method are automatically saved with the same method name.
7. Push **EXIT** until the meter goes back to the measurement mode.

Change calibration options

1. Make sure that a probe is connected to the meter.
2. Push  and select PHC705 Settings.
3. Select Modify Current Settings.
4. Select Calibration Options and update the settings:

Option	Description
Buffer Set	<p>Sets the temperature compensated buffer set for calibration:</p> <ul style="list-style-type: none"> • Color Coded—4.01, 7.00, 10.01 (default) • IUPAC—4.01, 7.00, 10.01, 12.45 • DIN—4.65, 9.23 • IUPAC—4.01, 6.86, 10.01, 12.45 • IUPAC—4.01, 6.86, 9.18, 12.45 • IUPAC—4.01, 7.00, 9.18, 12.45 • Custom Buffer Set (refer to Table 3) <p>Custom buffer sets are characterized at 25 °C (77 °F). Buffer set values show on the Calibration Options screen. Note: Measure only the minimum calibration points specified in Minimum Cal Points to complete a calibration.</p>
Buffer Set Values	<p>Sets the buffer values if Custom Buffer Set is selected (refer to Table 3).</p>
Minimum Cal Points	<p>Sets the minimum number of calibration points that are necessary to complete a calibration—1 (default), 2 or 3.</p>
Slope Limit	<p>Sets the slope limit—1% to 20% (acceptable slope criteria, default = 15%). Set the slope between the set limits for a correct calibration.</p>

- Select the Calibration Reminder and update the settings:

Option	Description
Reminder Repeat	The meter makes a sound when a calibration is necessary and at the selected interval—Off (default), 2 h, 4 h, 8 h, 2 d, 5 d or 7 d.
Expires	Calibration expires after the selected time—Immediately, Reminder + 30 min, Reminder + 1 h, Reminder + 2 h or Continue Reading. <i>Note: The meter cannot read samples after calibration has expired unless Continue Reading is selected.</i>

- If prompted, enter a name for the new method settings. Other changes made to the settings of an existing method are automatically saved with the same method name.
- Push **EXIT** until the meter goes back to the measurement mode.

Table 3 Custom buffer sets

Buffer set values	Option	Description
Std1 to Std5	1.09 pH—25 °C	Pre-set temperature compensated buffer values. <i>Note: It is necessary for selected standards to be different by a minimum of 2 pH units. For example, if 1.09 pH is selected for the first standard, the second standard must be different by at least 2 pH. Standards that do not meet this minimum will show gray on the screen and will not be selectable.</i>
	1.68 pH—25 °C	
	4.01 pH—25 °C	
	4.65 pH—25 °C	
	6.86 pH—25 °C	
	7.00 pH—25 °C	
	9.18 pH—25 °C	
	9.23 pH—25 °C	
	10.01 pH—25 °C	
	12.45 pH—25 °C	
	No Buffer	Select this option for undefined standards.

Change check standard options

- Make sure that a probe is connected to the meter.
- Push  and select PHC705 Settings.
- Select Modify Current Settings.

4. Select Check Standards Options and update the settings:

Option	Description
Standard	Sets the temperature compensated buffer value for check standard— <ul style="list-style-type: none">• 4.01 pH—25 °C• 4.65 pH—25 °C• 6.86 pH—25 °C• 7.00 pH—25 °C• 9.18 pH—25 °C• 9.23 pH—25 °C• 10.01 pH—25 °C• 12.45 pH—25 °C• Custom <p>The standard value shows on the Check Standard Options screen. No temperature compensation for custom buffers.</p>
Standard Value	When the Standard is set to Custom, enter the standard value with the up/down arrow keys.

5. Select Check Standard Reminder and update the settings:

Option	Description
Reminder Repeat	Sets the time interval for the check standard reminder—Off, 30 minutes, 2 h, 4 h, 8 h, 12 h or 24 h.
Allow Defer	Lets the postponement of check standard reminders—Yes or No.

6. Select Acceptance Criteria and update the settings:

Option	Description
Acceptance Limits	Sets the tolerance limits for check standard—0.005 pH (default) to 1.000 pH.
Cal Expires on Failure	Recalibration is necessary if check standard fails—Yes or No.

7. If prompted, enter a name for the new method settings. Other changes made to the settings of an existing method are automatically saved with the same method name.
8. Push **EXIT** until the meter goes back to the measurement mode.

Maintenance

Clean the probe

Clean the probe when there is contamination on the sensor. Symptoms of contamination are:

- Readings are not accurate or consistent.
 - The stabilization time is slow.
 - A calibration error occurs.
 - Contamination is visible on the probe (e.g., dirt).
1. Rinse the probe with deionized water. Blot dry with a no-lint cloth.
 2. Soak the glass bulb of the probe in the applicable cleaning agent. Refer to [Table 4](#).
Note: Remove KCl salt build-up from the probe with warm deionized water.
 3. Rinse or soak the probe for 1 minute in deionized water.
 4. Soak the probe in pH 4 buffer for 20 minutes.
 5. Rinse the probe with deionized water.
 6. Blot dry with a no-lint cloth.

Table 4 Cleaning agent

Contaminant	Cleaning agent	Soak time
General contaminants	Electrode cleaning solution	12–16 hours
Mineral deposits	0.1 N HCl solution	10–15 minutes
Fats, grease and oils	Warm, mild detergent solution	2 hours (maximum)
Protein deposits	Pepsin cleaning solution	3 hours (maximum)
Inorganic buildup	EDTA solution	3 hours (maximum)

Replace the filling solution

Replace the filling solution and KCl crystals (if applicable) when either occurs:

- The filling solution becomes contaminated.
 - The KCl crystals in a Red Rod probe no longer move freely through the liquid when the probe is inverted.
1. Use a syringe or small pipette to remove as much filling solution from the probe as possible.
 2. For Red Rod probes, if KCl crystals are still in the probe:
 - a. Fill the probe half full with the filling solution.
 - b. With a finger over the filling hole, shake the probe until the crystals become loose.
 - c. If the crystals will not loosen, fill the probe with filling solution. Put the probe into a warm water bath for approximately 10 minutes (up to 60 °C (140 °F)).
 - d. Do step 1 again.
 3. For Red Rod probes, add approximately 0.5 cm (0.2 in.) of KCl crystals to the probe through the filling hole. For measurements at temperatures more than 60 °C (140 °F), more crystals are necessary. Refer to [Preparation for use](#) on page 2.
 4. Fill the probe. Refer to [Fill the probe](#) on page 11.

Fill the probe

Add filling solution to the probe when the filling solution level is low (refer to [Preparation for use](#) on page 2) or is replaced (refer to [Replace the filling solution](#) on page 11). Refer to [Specifications](#) on page 1 for the applicable filling solution.

1. If the filling hole is closed, remove the filling-hole cap from the filling hole (refer to [Product overview](#) on page 2).
2. Remove the cap from the tip of the filling solution bottle.
3. Hold the bottle so that the tip is down. Put the tip of the bottle in the filling hole.
4. Slowly squeeze the bottle and fully fill the probe.
Note: Fully fill the probe for the best performance.
5. Put the probe into storage if not used immediately (refer to [Storage](#) on page 11).
6. Keep the filling solution bottle and cap for later use.
Note: If the dispensing tip becomes clogged, remove the dispensing tip and soak the tip in warm water. Fully dry and assemble the tip.

Storage

Short-term and long-term storage

For the best probe performance, do not let the reference junction become dry.

Note: Keep the probe in a sample for a maximum of 2 hours if the sample pH is not too high.

1. Put the filling-hole cap in the filling hole (refer to [Product overview](#) on page 2).
2. Rinse the probe with deionized water. Dry the probe with a no-lint cloth.
3. Fill the probe soaker bottle half full with the applicable Storage Solution (refer to [Specifications](#) on page 1) .
4. Loosen the soaker bottle cap and put the soaker bottle on the probe.
5. Turn the soaker bottle cap clockwise to tighten the soaker bottle cap.
6. Make sure that the solution in the soaker bottle fully covers the glass bulb and the reference junction.

Rehydration

If the glass bulb becomes dry:

1. Soak the probe tip in the 4.01 and 7.00 buffers each for 5 minutes.
2. Rinse the probe with deionized water. Blot dry with a no-lint cloth.
3. Calibrate the probe.

Troubleshooting

Message or symptom	Possible cause	Action
Probe not supported	Software not updated	To download the most current version of the software, refer to the applicable product page on the manufacturer's website. Refer to the HQd Series meter documentation for more information.
	HQd meter does not sense the IntelliCAL [®] probe	Contact technical support.
Connect a probe or probe requires service	Probe not connected correctly	Disconnect, then connect the probe. Tighten the locking nut.
	Software not updated	To download the most current version of the software, refer to the applicable product page on the manufacturer's website. Refer to the HQd Series meter documentation for more information.
	Large number of methods stored on probe	If the probe has a large number of stored methods, more time is necessary for connection. Do not disconnect the probe, continue to let the probe connect.
	Damaged probe	Make sure that there is connectivity with another probe or meter to confirm isolated issue with probe. Contact technical support.
pH reading and/or mV reading is same for all solutions	Soaker bottle not removed	Remove the soaker bottle.
	Electrical issue	Contact technical support.
Standard not recognized error	Soaker bottle not removed	Remove the soaker bottle.
	Incorrect buffer or contamination in the buffer solution	Use fresh buffer solution as specified in the method.
	Contamination in the filling solution	Drain and replace the filling solution with fresh solution.

Message or symptom	Possible cause	Action
Slow stabilization time	Tape not removed from the filling-hole	Remove the tape.
	Contamination in the glass sensor	Clean the probe. Refer to Clean the probe on page 10.
	Contamination in the filling solution	Drain and replace the filling solution with fresh solution.
	Filling hole closed	Make sure that the filling hole is open and above the solution level.
	Poor contact between reference junction and solution	Shake the probe in the solution from side to side to refresh the reference junction.
	LIS sample	Soak the probe in the sample for 10 to 15 minutes before the initial measurement or use a LIS chamber or flow-through cell.
	Low sample temperature or temperature difference between samples	Examine the sample temperature. The lower the temperature or the higher difference of temperatures between samples, the longer the stabilization time will be.
	Air bubbles around inner reference electrode	Carefully tap the probe with hand or shake the probe downward to remove any air bubbles.
	Dehydrated glass bulb	Rehydrate the probe. Refer to Storage on page 11.
	Not sufficient electrolyte flow ¹	Open the sleeve junction.
pH probe too old (membrane degradation)	Replace the probe.	
Calibration errors	Calibration not done correctly	Calibrate again with fresh pH buffers.
	Contaminated glass sensor	Clean the probe. Refer to Clean the probe on page 10.
	Slope exceeds the criteria for % of theoretical (as defined in the method slope limit)	<ol style="list-style-type: none"> 1. Adjust the slope limits by changing the PHC705 calibration settings and method. 2. Calibrate again the probe. 3. Make a check standard to examine the performance of the probe.

Message or symptom	Possible cause	Action
Drifting/Inaccurate readings	Contaminated glass bulb	Clean the probe. Refer to Clean the probe on page 10.
	CO ₂ absorption (for low ionic strength or high purity sample)	Use the LIS chamber for LIS/high purity samples to prevent sample contamination.
	Clogged reference	Make sure that the filling hole is not covered. Rinse the reference junction holes with deionized water. Carefully tap the probe with hand or shake the probe to remove air bubbles. If there are salt crystals around the junction, soak the electrode tip in a 60 °C (140 °F) water bath for 10 minutes.
	Improper storage conditions/ Dehydrated glass bulb	Clean or condition the probe and calibrate again. The probe can not operate correctly if the probe was left dry for a long time. Rehydrate the probe. Refer to Storage on page 11.
	Colloidal and/or particulates in the filling solution	Replace the filling solution, calibrate and test again.
	Air bubbles around inner reference electrode	Carefully tap the probe with hand or shake the probe to remove air bubbles.
	Not sufficient electrolyte flow ¹	Open the sleeve junction.
	Not sufficient stirring	Stir the standards and samples at a slow and steady rate to prevent the formation of a vortex.
Out of range	Measurement value is out of range	Make sure that the sample is in the range of the probe.
Out of limits	Check Standard value is out of limits in the current method	Make sure that the standard is in the limits of the current method.
		Do another method that expands the acceptable limits.
	Measurement value is out of measurement limits in the current method	Make sure that the sample is in the limits of the current method.
		Make a new method with an expanded range.
Temperature out of range	Temperature value is out of range	Make sure that the sample temperature is in the range of the probe.
		Make sure that the temperature sensor works correctly.
	Measured temperature is out the range of the probe	Make sure that the standard temperature is in the range of the probe.
		Make sure that the temperature sensor works correctly.
	Check standard temperature value is out of range	Make sure that the check standard temperature is in the range of the probe.

¹ Only applicable for probes with sleeve junction.

Consumables and accessories

Description	Quantity	Item Number
Electrode filling solution, saturated KCl	59 mL	25118059
Electrode filling solution, saturated KCl	500 mL	25118049
KCl crystals (Radiometer Analytical)	15 g	S21M001
Hach Electrode Cleaning Solution	500 mL	2965249
EDTA standard solution, 0.20N	500 mL	102149
Soaker bottle	1	5192900

Consumables and accessories (continued)

Description	Quantity	Item Number
LIS chamber assembly	1	5189900
Color-coded pH standards (buffers)		
pH 4.01 ±0.02 at 25 °C (77 °F), 500 mL	1	2283449
pH 7.00 ±0.02 at 25 °C (77 °F), 500 mL	1	2283549
pH 10.01 ±0.02 at 25 °C (77 °F), 500 mL	1	2283649
pH 4.01 ±0.02 at 25 °C (77 °F), 4 L	1	2283456
pH 7.00 ±0.02 at 25 °C (77 °F), 4 L	1	2283556
pH 10.01 ±0.02 at 25 °C (77 °F), 4 L	1	2283656
pH 4.01 ±0.02 at 25 °C (77 °F), 20 L	1	2283461
pH 7.00 ±0.02 at 25 °C (77 °F), 20 L	1	2283561
pH 10.01 ±0.02 at 25 °C (77 °F), 20 L	1	2283661
IUPAC series certified pH standards (buffers) ¹		
pH 4.005 ±0.010 at 25 °C (77 °F), 500 mL	1	S11M002
pH 6.865 ± 0.010 at 25 °C (77 °F), 500 mL	1	S11M003
pH 7.000 (Radiometer Analytical) ±0.010 at 25 °C (77 °F), 500 mL	1	S11M004
pH 9.180 ± 0.010 at 25 °C (77 °F), 500 mL	1	S11M006
pH 10.012 ± 0.010 at 25 °C (77 °F), 500 mL	1	S11M007
pH 12.45 ± 0.05 at 25 °C (77 °F), 500 mL	1	S11M008
Technical grade pH standards (buffers)		
pH 4.65 at 25 °C (77 °F), 500 mL	1	S11M010
pH 9.23 at 25 °C (77 °F), 500 mL	1	S11M011

¹ Certified standards ship with certificates for traceability to Standard Reference Materials

HACH COMPANY World Headquarters

P.O. Box 389, Loveland, CO 80539-0389 U.S.A.
Tel. (970) 669-3050
(800) 227-4224 (U.S.A. only)
Fax (970) 669-2932
orders@hach.com
www.hach.com

HACH LANGE GMBH

Willstätterstraße 11
D-40549 Düsseldorf, Germany
Tel. +49 (0) 2 11 52 88-320
Fax +49 (0) 2 11 52 88-210
info@hach-lange.de
www.hach-lange.de

HACH LANGE Sàrl

6, route de Compois
1222 Vézenaz
SWITZERLAND
Tel. +41 22 594 6400
Fax +41 22 594 6499

