

Front View

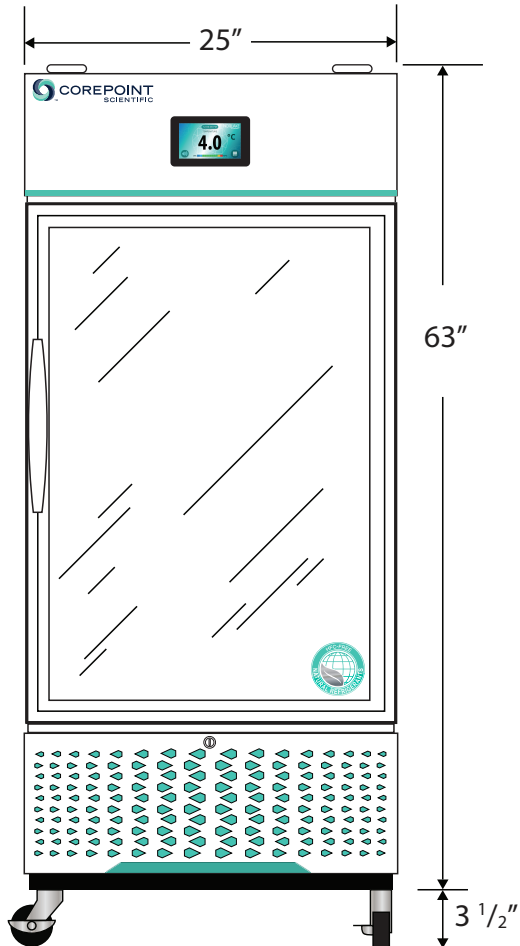

Side View

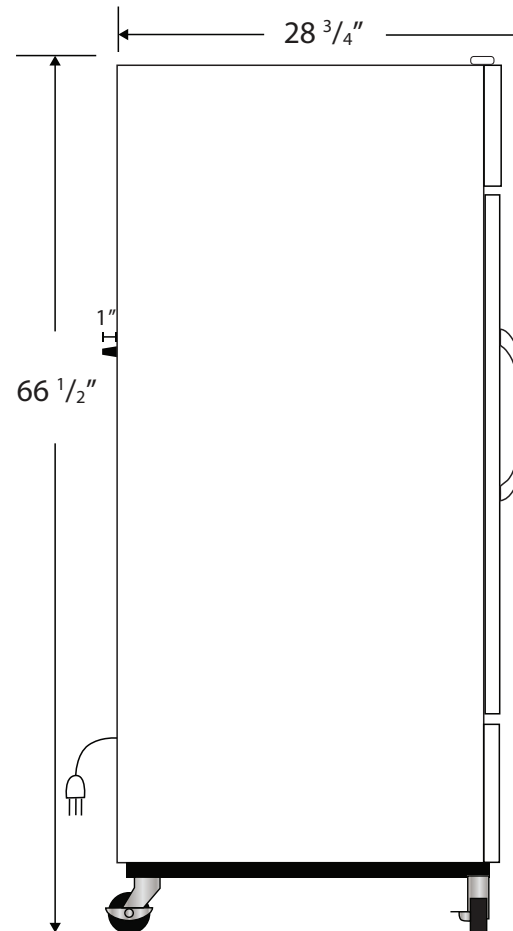

Top View

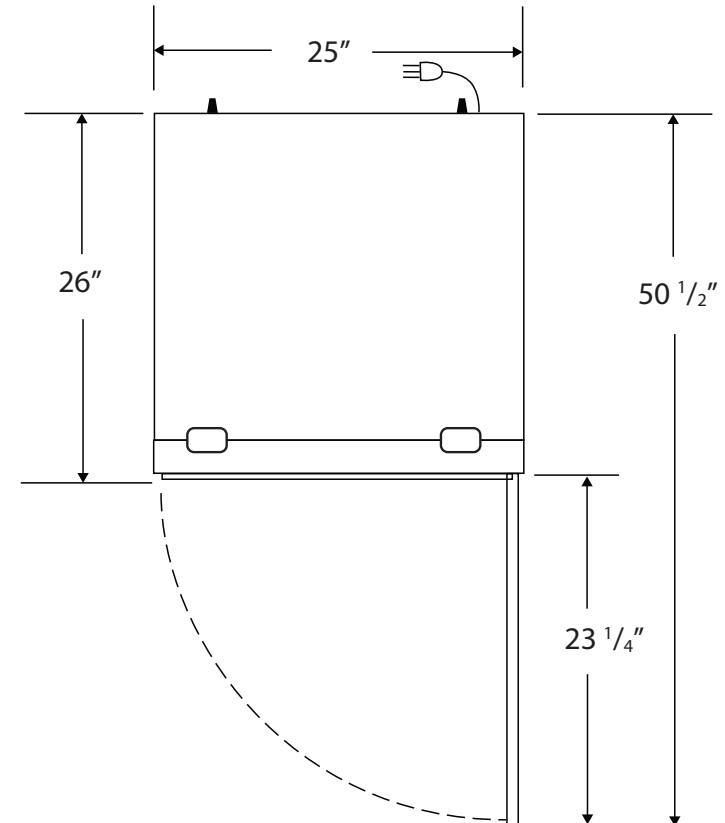
 115VAC/60Hz/1PH
 NEMA-5-15P

Cu. Ft	Defrost	Door	Int Door	Shelves	W"	D"	H"	Refrigerant	H.P.	Amps	Weight
12	Cycle	1 Glass	0	5 Adj	25	29 3/4	66 1/2	R290	1/5	3	218 lbs.