

English

OPERATING MANUAL

Refrigerated / Heating Circulator
F34-ED

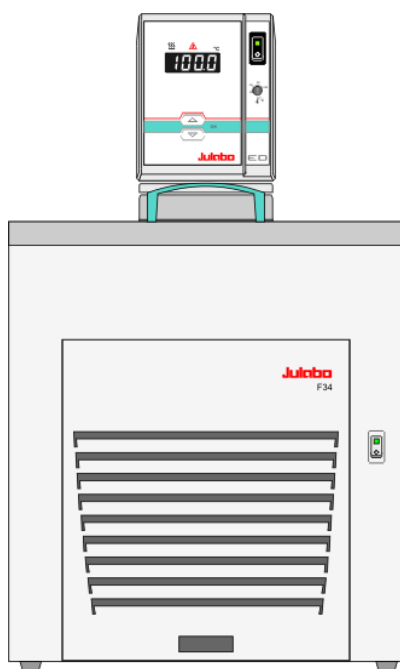

Julabo
THE TEMPERATURE CONTROL COMPANY

JULABO USA, Inc.
884 Marcon Boulevard
Allentown, PA 18109
Phone: +1(610) 231-0250
Fax: +1(610) 231-0260
info @ julabo.com
www.julabo.com

Congratulations!

You have made an excellent choice.

JULABO thanks you for the trust you have placed in us.

This operating manual has been designed to help you gain an understanding of the operation and possible applications of our circulators. For optimal utilization of all functions, we recommend that you thoroughly study this manual prior to beginning operation.

The JULABO Quality Management System



Temperature control devices for research and industry are developed, produced, and distributed according to the requirements of ISO 9001:2008. Certificate Registration No. 01 100044846

Unpacking and inspecting

Unpack the circulator and accessories and inspect them for possible transport damage. Damage should be reported to the responsible carrier, railway, or postal authority, and a damage report should be requested. These instructions must be followed fully for us to guarantee our full support of your claim for protecting against loss from concealed damage. The form required for filing such a claim will be provided by the carrier.

1.953.0274 01/11 Printed in Germany Changes without prior notification reserved

TABLE OF CONTENTS

Operating manual.....	4
1. Intended use	4
1.1. Description.....	4
2. Operator responsibility – Safety recommendations.....	4
2.1. Disposal.....	6
2.2. Technical specifications.....	7
Operating instructions	9
3. Safety notes for the user.....	9
3.1. Explanation of safety notes.....	9
3.2. Explanation of other notes	9
3.3. Safety recommendations	10
4. Operating controls and functional elements.....	12
5. Preparations.....	14
5.1. Installation.....	14
5.2. Bath fluids	15
5.3. Filling / Draining	16
5.4. Temperature application to external systems	17
5.5. Tubing.....	17
5.6. Adjusting the pump flow.....	18
6. Operating procedures	19
6.1. Power connection	19
6.2. Switching on / Start – Stop.....	19
6.3. Automatic / non-automatic start mode	20
6.4. Setting the temperatures.....	21
6.5. Safety installations according to IEC 61010-2-010	21
6.5.1. Excess temperature protection.....	21
6.5.2. Low liquid level protection	21
7. Troubleshooting guide / Error messages	22
8. Cleaning / repairing the unit	23
9. WARRANTY PROVISIONS	25

Operating manual

1. Intended use

JULABO circulators have been designed to control the temperature of specific fluids in a bath tank. The units feature pump connections for temperature control of external systems (loop circuit).



JULABO circulators are not suitable for direct temperature control of foods, semi-luxury foods and tobacco, or pharmaceutical and medical products. Direct temperature control means unprotected contact of the object with the bath medium (bath fluid).

1.1. Description

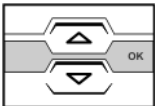

- The circulators are operated via the splash-proof keypad. The implemented microprocessor technology allows to set and to store the setpoint that can be indicated on the LED temperature display.
- The PID temperature control adapts the heat supplied to the thermal requirements of the bath.
- Safety installations conforming to IEC 61010-2-010
The excess temperature protection is a safety installation independent from the control circuit.
The safety value is set using a tool (screwdriver).
If the low level protection device is triggered, a complete shutdown of the heater and circulating pump is effected.

2. Operator responsibility – Safety recommendations

The products of JULABO ensure safe operation when installed, operated, and maintained according to common safety regulations. This section explains the potential dangers that may arise when operating the circulator and also specifies the most important safety precautions to preclude these dangers as far as possible.

Persons:

The operator is responsible for the qualification of the personnel operating the units. The operator should be constantly informed about the dangers involved with their job activities as well as preventive actions. Make sure all persons expected to carry out operation, installation and maintenance of the unit read and understand the safety information and operating instructions.

If you have any questions concerning the operation of your unit or the information in this manual, please contact us!

Contact

JULABO USA, Inc.
884 Marcon Boulevard
Allentown, PA 18109

Phone: +1(610) 231-0250
Fax: +1(610) 231-0260
info @ julabo.com
www.julabo.com

Handling:

- Nevertheless, avoid strikes to the housing, vibrations, damages to the keypad foil (keys, display) or contamination.
- Make sure the product is regularly checked for proper condition.
- Regularly check (at least every 2 years) the proper condition of the mandatory, warning, prohibition and safety labels.
- Take care that the mains supply features a low impedance to avoid any negative affects on the instrument being operated in the same mains.
- This unit is designed for operation in a controlled electromagnetic environment. This means that transmitting devices (e.g. cellular phones) should not be used in the immediate vicinity.
Magnetic radiation may influence other units with components susceptible to magnetic fields (e.g. a monitor). We recommend to keep a minimum distance of 1 m.
- Permissible ambient temperature: max. 40 °C, min. 5 °C.
- Permissible relative air humidity: 50 % (40 °C).
- Do not store in an aggressive atmosphere. Protect from contaminations.
- Do not expose to sunlight.

Appropriate operation:

Only qualified personnel is authorized to perform configuration, installation, maintenance and repairs of the circulator.

Routine operation can also be carried out by untrained personnel who should however be instructed by trained personnel.

Use:

The bath may **not** be filled with flammable materials. Fire hazard!

Only use recommended materials (bath fluids). Only use recommended materials (bath fluids).

Only use non-acid and non corroding materials.



Operator responsibility – Safety recommendations

When using hazardous materials or materials that could become hazardous, **the operator must** affix the enclosed safety labels to the front of the unit so they are highly visible:

If this unit is intended for use within the United States of America, all 3 warning labels must be affixed to the housing of the unit prior to use.

Directions for the positioning of the individual warning labels are enclosed with the warning labels included in the delivery.

Warning labels must be easily visible to users.

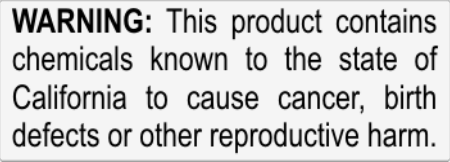
1		Warning label W00: Colors: yellow, black Danger area. Attention! Observe instructions. (operating manual, safety data sheet)
2		Mandatory label M018: Colors: blue, white Carefully read the user information prior to beginning operation. Scope: EU
or		
2		Semi S1-0701 Table A1-2 #9 Carefully read the user information prior to beginning operation. Scope: USA, NAFTA
3		Warning label Proposition 65

Particular care and attention is necessary because of the wide operating range.

There are thermal dangers:

Burn, scald, hot steam, hot parts and surfaces that can be touched.

	Warning label W26: Colors: yellow, black Hot surface warning. (The label is put on by JULABO)
---	---

2.1. Disposal

Do not dispose of the unit with household waste! This unit contains the refrigerants R134a – at this time considered not to have any negative effects on the ozone layer. However, during the long operating period of the unit, disposal prescriptions may change. So only qualified personnel should take care of disposal.



Contact an authorized waste management company in your country.
Disposal with household waste (unsorted waste) or similar collections of municipal waste is not permitted!

2.2. Technical specifications

			F34-ED
Working temperature range	°C		-30 ... 100
Temperature stability	°C		±0,03
Temperature selection			digital
Temperature indication			LED
Resolution	°C		0.1
Temperature control			
Heater wattage (at 230 V)	kW		2,0
Heater wattage (at 115V)	kW		1,0
Cooling capacity	°C		<u>+20</u> 0 <u>-20</u>
Medium ethanol	kW		0.45 0.32 0.14
Refrigerant			R134a
Circulating pump:			
discharge, max.at 0 bar	l/min		15
pressure, max. at 0 l	bar		0.35
Overall dimensions (WxDxH)	cm		38x58x62
Bath opening (WxL)	cm		24x30
Bath depth	cm		15
Filling volume	liters		14 ... 20
Weight	kg		41
Ambient temperature	°C		5 ... 40
Mains power connection 230 V/50 Hz	V/ Hz		207-253 / 50
Current input (at 230 V)	A		12
Mains power connection 230 V/60 Hz	V/ Hz		207-253 / 60
Current input (at 230 V)	A		13
Mains power connection 115 V/60 Hz	V/ Hz		103-127 / 60
Current input (at 115 V)	A		14
Mains power connection 100 V/50-60 Hz	V/ Hz		-----
Current input (at 100 V)	A		-----

All measurements have been carried out at:
 rated voltage and frequency ambient temperature: 20 °C
 Technical changes without prior notification reserved.

Safety installations according to IEC 61010-2-010:

Excess temperature protection	adjustable from 20 to 120 °C
Low liquid level protection	float switch
Classification according to DIN 12876-1	class I
Alarm indication	optical + audible (permanent)

Environmental conditions according to EN 61 010, part 1:

Use only indoor.

Altitude up to 2000 m - normal zero.

Ambient temperature: +5 ... +40 °C (for storage and transportation)

Air humidity:

Max. rel. humidity 80 % for temperatures up to +31 °C,

linear decrease down to 50 % relative humidity at a temperature of +40 °C

Max. mains fluctuation of ± 10 % are permissible.

Protection class according to EN 60 529 IP21

The unit corresponds to Class I

Overvoltage category II

Pollution degree 2



Caution:

The unit is not for use in explosive environment.

Standards for interference resistance according to EN 61326-1

This unit is an ISM device classified in Group 1 (using high frequency for internal purposes)

Class A (industrial and commercial range).

Operating instructions

3. Safety notes for the user

3.1. Explanation of safety notes



In addition to the safety warnings listed, warnings are posted throughout the operating manual. These warnings are designated by an exclamation mark inside an equilateral triangle. “Warning of a dangerous situation (Attention! Please follow the documentation).”

The danger is classified using a signal word.

Read and follow these important instructions for averting dangers.



Warning:

Describes a **possibly** highly dangerous situation. If these instructions are not followed, serious injury and danger to life could result.



Caution:

Describes a **possibly** dangerous situation. If this is not avoided, slight or minor injuries could result. A warning of possible property damage may also be contained in the text.



Notice:

Describes a **possibly** harmful situation. If this is not avoided, the product or anything in its surroundings can be damaged.

3.2. Explanation of other notes



Note!

Draws attention to something special.



Important!

Indicates usage tips and other useful information.

3.3. Safety recommendations

Follow the safety recommendations to prevent damage to persons or property. Further, the valid safety instructions for working places must be followed.



- Only connect the unit to a power socket with earthing contact (PE – protective earth)!
- The power supply plug serves as safe disconnecting device from the line and must be always easily accessible.
- Operation is permitted with non-flammable liquids only.
- Place the instrument on an even surface on a pad made of non-inflammable material.
- Do not stay in the area below the unit.
- Make sure you read and understand all instructions and safety precautions listed in this manual before installing or operating your unit.
- Never operate the unit without bath fluid in the bath.
- Check the filling level of the bath fluid from time to time. Pump and heater must always be fully covered with the bath fluid!
- The instrument is not suited for unsupervised continuous operation.
- Do not drain the bath fluid while it is hot!
Check the temperature of the bath fluid prior to draining (by switching the unit on for a short moment for example).
- Observe the limited working temperature range when using plastic bath tanks.
- Employ suitable connecting tubing.
Make sure that the tubes are securely attached.
- Never operate damaged or leaking equipment.
- Always turn off the unit and disconnect the mains cable from the power source before performing any service or maintenance procedures, or before moving the unit.
- Always empty the bath before moving the unit.
- Never operate equipment with damaged mains power cables.



- Some parts of the bath cover and the pump connections may become extremely warm during continuous operation. Therefore, exercise particular caution when touching these parts.



- Notice:** Check the safety installations at least twice a year!
- Excess temperature protection according to IEC 61010-2-010.
With a screwdriver turn back the adjustable excess temperature protection until the shut-down point (actual temperature).
 - Low level protection according to IEC 61010-2-010.
To check the function of the float, it can be manually lowered with a screwdriver for example.

**Caution:**

The temperature controlling i.e. of fluids in a reactor constitutes normal circulator practice.

We do not know which substances are contained within these vessels. Many substances are:

- inflammable, easily ignited or explosive
- hazardous to health
- environmentally unsafe

i.e.: **dangerous**

The user alone is responsible for the handling of these substances!

The following questions shall help to recognize possible dangers and to reduce the risks to a minimum.

- Are all tubes and electrical cables connected and installed?
Note:
sharp edges, hot surfaces in operation, moving machine parts, etc.
- Do dangerous steams or gases arise when heating?
Is an exhaust needed when working?
- What to do when a dangerous substance was spilled on or in the unit?
Before starting to work, obtain information concerning the substance and determine the method of decontamination.

**WARNING**

This product contains chemicals known to the state of California to cause cancer, birth defects or other reproductive harm.

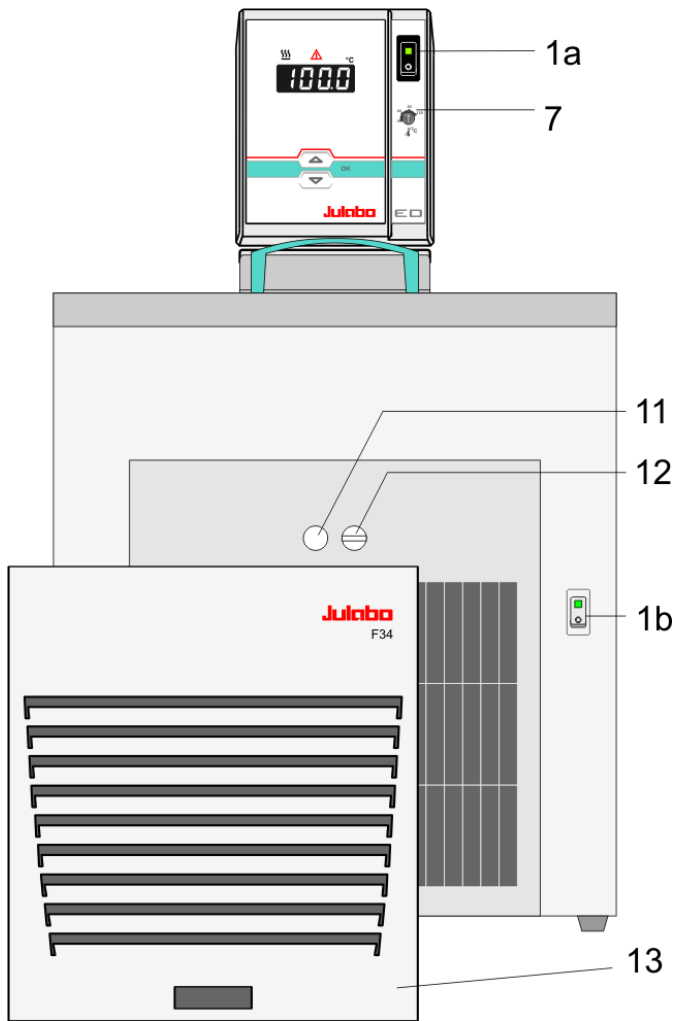

4. Operating controls and functional elements

Front view

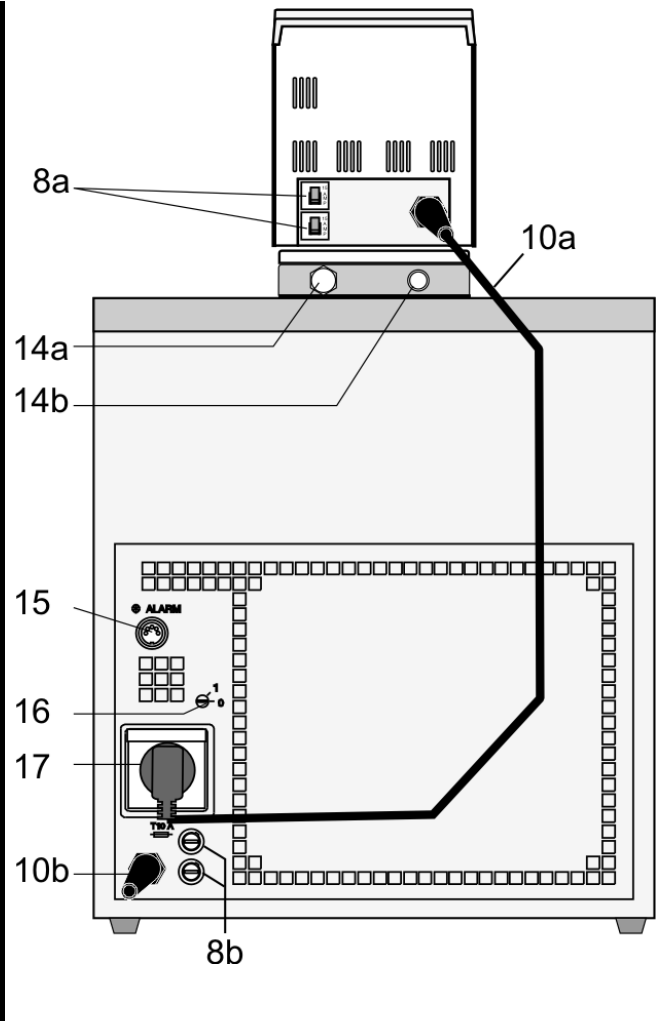

Rear view



- 1a  Mains power switch, illuminated for circulator
- 1b  Mains power switch, illuminated for cooling machine





- 2  Edit keys
Setpoint increase or decrease
Press keys shortly for step-by-step changes,
Keep the keys pressed for fast change of setpoint

- 3  OK key (store)

- 4  LED temperature display, menu indication

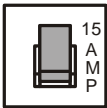
- 5  Control indicator –Heating

- 6  Control indicator – Alarm

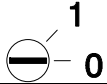
7		Adjustable excess temperature protection according to IEC 61010-2-010
8a		Circulator: Mains circuit breakers (resettable) 15 A
8b		Mains fuses for cooling machine: T 10,0 A, D5 x 20 mm
10a		Mains power cable with plug for circulator
10b		Mains power cable with plug cooling machine
11		Drain port
12		Drain tap 
13		Venting grid, removable
14a		Pump connector for feed
14b		Pump connector for return
15	 	Connector: Cooling machine control (not in use for operation with ED circulator)
16		Selector dial for cooling machine Position "0" for operation with ED circulator.
17		Built-in mains outlet for connection of circulator

5. Preparations

5.1. Installation

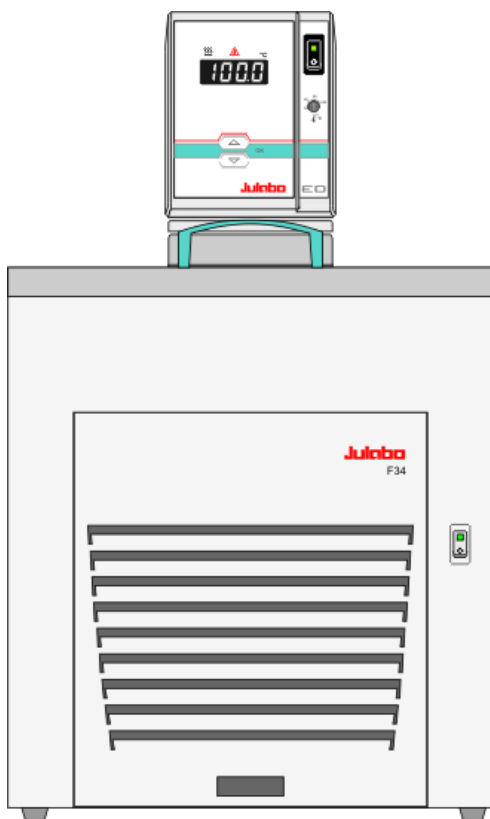
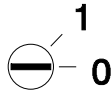

- Place the unit on an even surface on a pad made of **non-flammable** material.
- The circulator fitted with a stainless steel bridge is placed on the back of the bath tank leaving the bath open on the front side.
- Set selector dial for cooling machine (16) in position "0" for operation with ED circulator.
- Keep at least 20 cm of open space on the front and rear venting grids.
- Do not set up the unit in the immediate vicinity of heat sources and do not expose to sun light.
- Before operating the unit after transport, wait about one hour after setting it up. This will allow any oil that has accumulated laterally during transport to flow back down thus ensuring maximum cooling performance of the compressor.
- The place of installation should be large enough and provide sufficient air ventilation to ensure the room does not warm up excessively because of the heat the instrument radiates to the environment. (Max. permissible ambient temperature: 40 °C). With regard to a disturbance in the cooling loop (leakage), the guideline EN 378 prescribes a certain room space to be available for each kg of refrigerant.
The necessary amount of refrigerant is specified on the type plate.
> For 0.25 kg of refrigerant R134a, a room space of 1 m³ is required.

5.2. Bath fluids



Caution:

No liability for use of other bath fluids!
Do not use flammable bath fluids!

Water: The quality of water depends on local conditions.

- Due to the high concentration of lime, hard water is not suitable for temperature control because it leads to calcification in the bath.
- Ferrous water can cause corrosion - even on stainless steel.
- Chloric water can cause pitting corrosion.
- Distilled and deionized water is unsuitable. Their special properties cause corrosion in the bath, even in stainless steel.

Recommended bath fluids:

Bath fluid	Temperature range
soft/decalcified water	5 °C to 80 °C
mixture water/glycol, mixture 1:1	-20°C to 50°C
Thermal G	-30°C to 80°C

JULABO Bath liquids	Order No.
Thermal G 10 Liters	8 940 124
Thermal G 5 Liters	8 940 125



See website for list of recommended bath fluids.



Notice:

Only use non-acid and non-corroding bath fluids.

JULABO takes no responsibility for damages caused by the selection of an unsuitable bath fluid.

Unsuitable bath fluids are liquids which e.g.

- are very highly viscous
(much higher than 30 mm² /s at the respective working temperature)
- have corrosive characteristics or
- tend to cracking.

5.3. Filling / Draining



Notice: Filling
Check the filling level of the bath fluid from time to time. Pump and heater must always be fully covered with the bath fluid!

The instrument is **not** suited for unsupervised continuous operation.

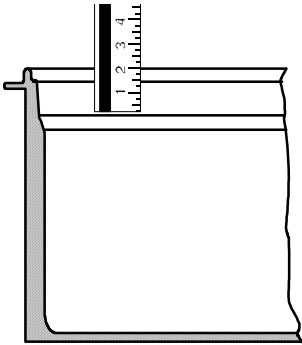

Filling

- Take care that no liquid enters the interior of the circulator.
- Recommended maximum filling level with water as bath liquid: 20 mm below the tank rim
- ⓘ After filling, immerse the samples in the bath or place the lid on the bath, in case the opening is not to be used.

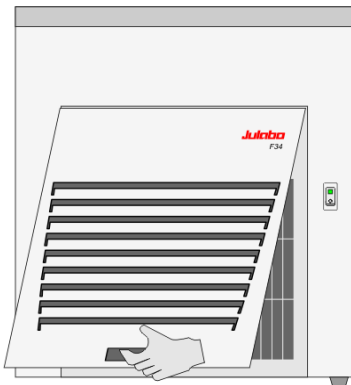

Draining

- Turn off the circulator and cooling machine.
- Hold the venting grid, pull out and remove.
- Slide a short piece of tube onto the drain port (11) and hold it into a pail.
- Unscrew the drain tap (12) and empty the unit completely.
- Tighten the drain tap.

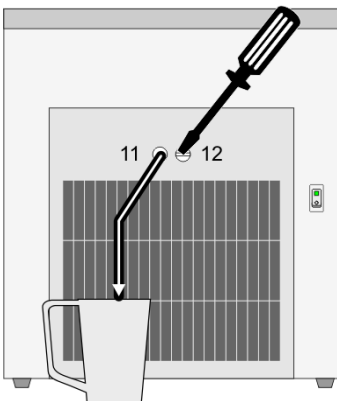

Notice: Draining
Do not drain the bath fluid while it is hot!
Recommendation: Temperature range 5 °C to 40 °C

Check the temperature of the bath fluid prior to draining (by switching the unit on for a short moment, for example).

5.4. Temperature application to external systems



Caution:

Securely attach all tubing to prevent slipping.

If the circulator is operated without external system, close the pump connector (14a) with the cap nut.

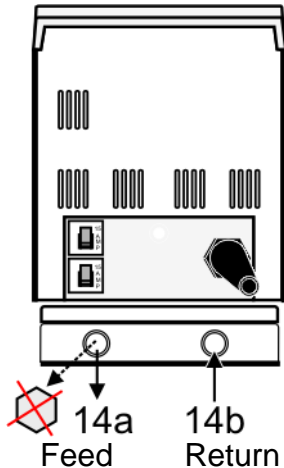

The circulator is used for temperature application to external, closed systems (temperature loop) with simultaneous bath internal temperature application.

Connecting an external system:

- Unscrew the collar nut from the pump connector (14a).
- Slide the tubing onto the pump connectors for feed and return flow (14a, 14b). Secure the tubing with tubing clamps.

ⓘ Use tubing insulation.

5.5. Tubing

Recommended tubing:

Order No.	Length		Temperature range
8930008	1 m	CR [®] tubing 8 mm ID	-20 °C ... 120 °C
8930010	1 m	CR [®] tubing 10 mm ID	-20 °C ... 120 °C
8930108	1 m	Viton tubing 8 mm ID	-50 °C ... 200 °C
8930110	1 m	Viton tubing 10 mm ID	-50 °C ... 200 °C
8930410	1 m	Insulation for tubing 8 mm ID or 10 mm ID	-50 °C ... 100 °C
8970480		2 Tubing clamps, size 1 for tubing 8 mm ID	
8970481		2 Tubing clamps, size 2 for tubing 10 or 12 mm ID	



Warning: Tubing:

At high working temperatures the tubing used for temperature application and cooling water supply represents a danger source. A damaged tubing line may cause hot bath fluid to be pumped out within a short time.

This may result in:

- Burning of skin
- Difficulties in breathing due to hot atmosphere

Safety recommendations

- Employ suitable connecting tubing.
- Make sure that the tubing is securely attached.
- Avoid sharp bends in the tubing, and maintain a sufficient distance from surrounding walls.
- Regularly check the tubing for material defects (e.g. for cracks).
- Preventive maintenance: Replace the tubing from time to time.

5.6. Adjusting the pump flow

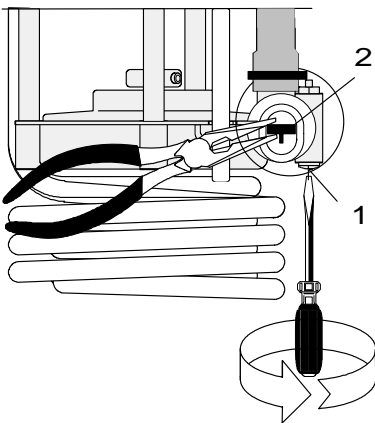

The pump flow is pre-adjusted in the factory and can be modified to suit user requirements.

- Using a screwdriver turn the screw (1) anti-clockwise by 360 °.
- Using flat pliers turn the marking of the slide (2) to the desired position.
- Tighten the screw.

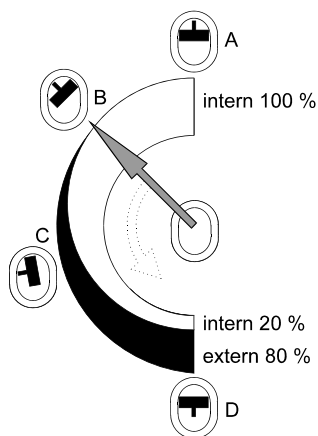

Examples:

Internal applications in the bath

- A 100 % internal bath circulation (for large bath tanks)
- B Reduced internal bath circulation (for smooth surface of bath fluid)

External/internal applications

- C 40 % external discharge, 60 % internal circulation (for large bath tanks)
- D 80 % external discharge, 20 % internal circulation (for small bath tanks)

6. Operating procedures

6.1. Power connection



Caution:

- Only connect the unit to a power socket with earthing contact (PE – protective earth)!
- The power supply plug serves as safe disconnecting device from the line and must be always easily accessible.
- Never operate equipment with damaged mains power cables.
- Regularly check the mains power cables for material defects (e.g. for cracks).
- We disclaim all liability for damage caused by incorrect line voltages!

Check to make sure that the line voltage matches the supply voltage specified on the identification plate.

- Connect the circulator with mains power cable (10a) to the mains outlet (17).
- Connect the refrigerated circulator with mains power cable (10b) to the mains socket.

6.2. Switching on / Start – Stop

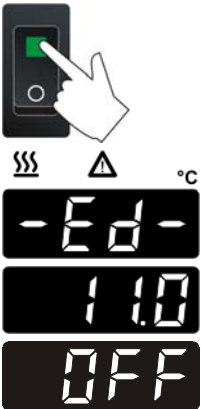

Switching on:

- Circulator and cooling machine may be turned on and off with separate mains switches. The integrated control light will illuminate to indicate that power has been applied.
- The unit performs a self-test. The segments of the 4-digit LED temperature DISPLAY and all indicator lights will illuminate (as illustrated on the left). Then the software version (example: 11.0) appears. The display „OFF“ indicates the unit is ready to operate. (standby mode).

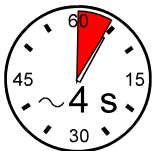

Start:

- Press the **OK** key for about 4 seconds.
The LED temperature DISPLAY indicates the actual bath temperature.

Stop:

- Press the **OK** key for about 4 seconds.
- Turn the unit off with the mains power switch.





Caution:

If the circulator is turned off with the mains switch (1a), the refrigerating unit is not switched off simultaneously.
Turn off the refrigerating unit with the mains switch (1b) as well.
Danger of freezing when water is used as bath fluid!

6.3. Automatic / non-automatic start mode

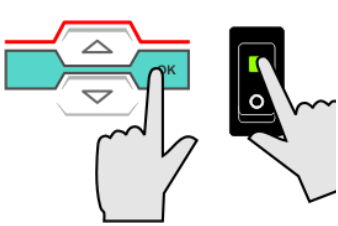

- ① Keep depressed the **OK** key and
- ② turn on the circulator with the mains power switch.

For a short while the LED temperature DISPLAY indicates the effective start mode:



⇒ AUTOSTART on.

⇒ AUTOSTART off.

NOTE:

The circulator has been configured and supplied by JULABO according to N.A.M.U.R. recommendations. This means for the start mode, that the unit must enter a safe operating state after a power failure (non-automatic start mode). This safe operating state is indicated by „OFF“ on the LED temperature display. A complete shutdown of the main functional elements such as heater and circulating pump is effected simultaneously.

Should such a safety standard not be required, the AUTOSTART function (automatic start mode) may be activated, thus allowing the start of the circulator directly by pressing the mains power switch or using a timer.







Warning:

For supervised or unsupervised operation with the AUTOSTART function, avoid any hazardous situation to persons or property.
The circulator does no longer conform to N.A.M.U.R. recommendations.
Take care you fully observe the safety and warning functions of the circulator.
The instrument is **not** suited for unsupervised continuous operation.

6.4. Setting the temperatures

Factory setting: 25 °C

① Setting can be carried out in the start/stop condition.

1. Press one of the keys   for a short moment. The setpoint value instead of the actual value is indicated on the display for about 8 seconds. The value can now be changed.
2. Change value:
 - Press  to set a higher value.
 - Press  to set a lower value.
 - Keep the keys depressed for the value to change fast.
3. Press the  key to store the value.

6.5. Safety installations according to IEC 61010-2-010

Check the safety installations at least twice a year (see page 10)!

6.5.1. Excess temperature protection

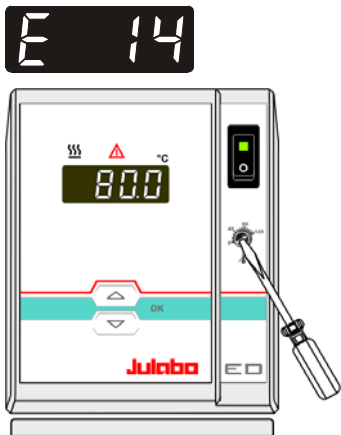

This safety installation is independent of the control circuit. When the temperature of the bath fluid has reached the safety temperature, a complete shutdown of the heater and pump is effected.

The alarm is indicated by optical and audible signals (continuous tone) and on the LED-DISPLAY appears the error message "Erro 14".

Setting range: 20 °C to 120 °C

- Using a screwdriver turn the setting screw to the desired value.

Recommendation:

Set the excess temperature protector at 5 to 10 °C above the working temperature setpoint.

6.5.2. Low liquid level protection



This safety installation is independent of the control circuit.

If the low liquid level protection device is triggered, a complete shutdown of the heater and circulating pump is effected.

The alarm is indicated by optical and audible signals (continuous tone) and on the LED-DISPLAY appears the error message "Error 01".

- ① Turn off the unit with the mains switch, refill bath fluid and turn the unit on again!

7. Troubleshooting guide / Error messages

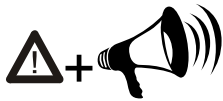

Whenever the microprocessor electronics registers a failure, a complete shutdown of the heater and circulating pump is performed. The alarm light "⚠" illuminates and a continuous signal tone sounds. The LED temperature display indicates the cause for the alarm in form of a code.



Press the **OK** key to quit the audible signal.



- The circulator is operated without bath fluid, or the liquid level is insufficient.
Replenish the bath tank with the bath fluid.
- Tube breakage has occurred (insufficient filling level due to excessive bath fluid pumped out). Replace the tubing and replenish the bath tank with the bath fluid.



- Cable of the working temperature sensor interrupted or short-circuited.



- Defect of the working or excess temperature sensor.
Working temperature and excess temperature sensors report a temperature difference of more than 35 K.



- Error in A/D converter



- The excess temperature value lies below the working temperature setpoint.
Set the excess temperature to a higher value.



- Cable of the excess temperature sensor interrupted or short-circuited.

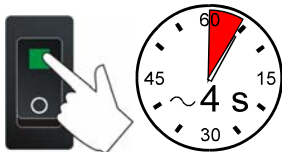

After eliminating the malfunction, press the mains power switch off and on again to cancel the alarm state.

If the unit cannot be returned to operation, contact an authorized JULABO service station.

Disturbances that are not indicated.

Pump motor overload protection

The pump motor is protected against overloading. After a short cooling interval, the motor will automatically start running.

Cooling compressor overload protection

The motor of the cooling compressor is equipped with an overload protector, which will be activated by excessive temperature in the capsule or by excessive current consumption. Poor air circulation (distance to walls, dirt accumulated on condenser) may cause the motor to be disconnected. After a short cooling interval, the motor will be automatically reconnected.

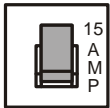

Circulator: Mains circuit breakers (resettable) 15 A

Cooling machine: Fuse T 10.0 A, dia.5 x 20 mm

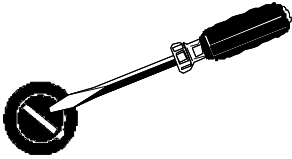

The mains fuses on the rear of the unit may easily be exchanged as shown on the left.



Warning:

Before exchanging the fuses, turn off the mains power switch and disconnect the power plug from the mains socket!

Only use fine fuses with a nominal value as specified.

Example:

Manufacturer	Supplier	Type	Order No.
Wickmann	Wickmann	G- fuse insert T10,0A 5x20 mm	No. 19195

8. Cleaning / repairing the unit



Caution:

- Always turn off the unit and disconnect the mains cable from the power source before cleaning the unit.
- Prevent humidity from entering into the circulator.
- Electrical connections and any other work must be performed by qualified personnel only.

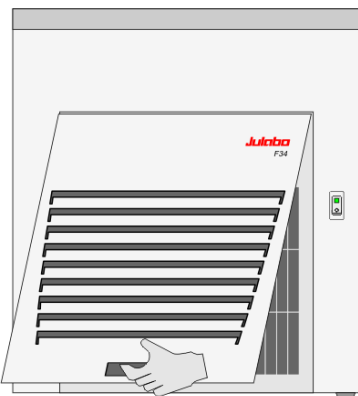

To maintain the full cooling performance, clean the condenser from time to time.

- Switch off the unit, disconnect mains power cable.
- Hold the venting grid, pull out and remove.
- Clean the ribbed condenser with a vacuum cleaner.
- Replace the venting grid.
- Switch on the unit.

Cleaning

For cleaning the bath tank and the immersed parts of the circulator, use low surface tension water (e.g., soap suds).

Clean the outside of the unit using a wet cloth and low surface tension water.

The circulator is designed for continuous operation under normal conditions. Periodic maintenance is not required.

The tank should be filled only with a bath fluid recommended by JULABO. To avoid contamination, it is essential to change the bath fluid from time to time.

Repairs

Before asking for a service technician or returning a JULABO instrument for repair, please contact an authorized JULABO service station.

When returning the unit:

- Clean the unit in order to avoid any harm to the service personnel.
- Attach a short fault description.
- When returning a unit, take care of careful and adequate packing.
- JULABO is not responsible for damages that might occur from insufficient packing.



JULABO reserves the right to carry out technical modifications with repairs for providing improved performance of a unit.

9. WARRANTY PROVISIONS

The following Warranty Provisions shall apply to products sold in North America by Julabo ("Seller") to the entity shown as buyer ("Buyer") on Seller's invoice.

1. **Initial Warranty.** Upon Seller's receipt of payment in full for the products and subject to Buyer's compliance with the terms of sale and any other agreement with Seller relating to the products, Seller warrants to the Buyer that the products manufactured by the Seller are free from defects in material and workmanship for a period not to exceed two (2) years or ten thousand (10,000) hours of operation, whichever comes first, from the date the product is shipped by Seller to Buyer (the "Initial Warranty").

2. **EXCLUSION OF ALL OTHER EXPRESS WARRANTIES; EXCLUSION OF ALL IMPLIED WARRANTIES.** OTHER THAN THE INITIAL WARRANTY, NO OTHER EXPRESS WARRANTIES ARE MADE. ALL IMPLIED WARRANTIES OF EVERY TYPE AND KIND, INCLUDING BUT NOT LIMITED TO ANY IMPLIED WARRANTY OF MERCHANTABILITY OR FITNESS FOR A PARTICULAR PURPOSE OR USE, ARE EXCLUDED IN ALL RESPECTS AND FOR ALL PURPOSES. SELLER DISCLAIMS AND MAKES NO IMPLIED WARRANTIES WHATSOEVER.

3. **Exclusions.** The Initial Warranty does not include damage to the product resulting from accident, misuse, improper installation or operation, unauthorized or improper repair, replacement or alteration (including but not limited to repairs, replacements, or alterations made or performed by persons other than Seller's employees or authorized representatives), failure to provide or use of improper maintenance, unreasonable use or abuse of the product, or failure to follow written installation or operating instructions. Buyer must return the product's record of purchase to the Seller or one of Seller's authorized representatives within thirty (30) days of the date the product is shipped by Seller to Buyer in order to make a claim under the Initial Warranty. Notwithstanding anything contained herein to the contrary, all glassware, including but not limited to reference thermometers, are expressly excluded from the Initial Warranty.

4. **Buyer's sole remedies; Limitations on Seller's Liability.** Buyer's sole and exclusive remedy under the Initial Warranty is strictly limited, in Seller's sole discretion, to either: (i) repairing defective parts; or (ii) replacing defective parts. In either case, the warranty period for the product receiving a repaired or replaced part pursuant to the terms of the Initial Warranty shall not be extended. All repairs or replacements performed by Seller pursuant to these Warranty Provisions shall be performed at Seller's facility in Allentown, Pennsylvania, U.S.A. or Vista, California, U.S.A or at the facility of an authorized representative of Seller, which location shall be determined by Seller in its sole discretion; provided, however, that Seller may, in its sole discretion perform such repairs or replacements at Buyer's facility in which case Buyer shall pay Seller's travel, living and related expenses incurred by Seller in performing the repairs or replacements at Buyer's facility. As a condition precedent to Seller's obligation to repair or replace a product part under the Initial Warranty, Buyer shall (i) promptly notify Seller in writing of any such defect; (ii) shall have returned the product's record of purchase to Seller or to one of Seller's authorized representatives within thirty (30) days of the date the product is delivered to Buyer; and (iii) assist Seller in all respects in its attempts to determine the legitimacy and basis of any claims made by or on behalf of Buyer including but not limited to providing Seller with access to the product to check operating conditions. If Buyer does not provide such written notice to Seller within the Initial Warranty period or fails to return the product's record of purchase as set forth above, Seller shall have no further liability or obligation to Buyer therefore. In no event shall Seller's liability under the Initial Warranty exceed the original purchase price of the product which is the subject of the alleged defect.

5. **THE REMEDIES PROVIDED IN THE INITIAL WARRANTY ARE THE SOLE AND EXCLUSIVE REMEDIES AVAILABLE TO THE BUYER. NOTWITHSTANDING ANYTHING TO THE CONTRARY CONTAINED HEREIN, AND EVEN IF THE SOLE AND EXCLUSIVE REMEDIES FAIL OF THEIR ESSENTIAL PURPOSE FOR ANY REASON WHATSOEVER, IN NO EVENT SHALL SELLER BE LIABLE FOR BUYER'S**

WARRANTY PROVISIONS

MANUFACTURING COSTS, LOST PROFITS, GOODWILL, OR ANY OTHER SPECIAL, INDIRECT, PUNITIVE, INCIDENTAL OR CONSEQUENTIAL DAMAGES TO BUYER OR ANY THIRD PARTY AND ALL SUCH DAMAGES ARE HEREBY DISCLAIMED.

6. **Assignment.** Buyer shall not assign any of its rights or obligations hereunder without the prior written approval of Seller; provided, however, that if Buyer is a distributor of Seller, the rights and obligations of Buyer under these Warranty Provisions shall inure to the benefit of and be binding upon Buyer's customers who provide the product's proof of purchase to Seller pursuant to the terms set forth herein. Seller may assign any or all of its rights or obligations hereunder without Buyer's prior consent.

7. **Governing Law.** The Warranty Provisions and all questions relating to their validity, interpretation, performance, and enforcement shall be construed in accordance with, and shall be governed by, the substantive laws of the Commonwealth of Pennsylvania without regard to its principles of conflicts of law.

8. **Waiver.** Any failure of the part of Seller to insist on strict compliance with the Warranty Provisions shall no way constitute a waiver of such right. No claim or rights arising out of a breach of the Warranty Provisions by Buyer may be discharged in whole or in part by a waiver of the claim or right, unless the waiver is in writing signed by an authorized representative of Seller. Seller's waiver or acceptance of any breach by Buyer of any provisions of the Warranty Provisions shall not constitute a waiver of or an excuse for nonperformance as to any other provision of the Warranty Provisions nor as to any prior or subsequent breach of the same provision.

9. **Freight.** Buyer will arrange and pay for shipping and handling charges for the unit to be returned to the Seller. Seller will arrange and pay for shipping and handling for the return of the unit to the Buyer.